

# RAK-CLEON



**RAK**  
CERAMICS

## ICONS



WALL HUNG WC



SEAT AND COVER



P-TRAP



WATER SUPPLY



PUSH PLATES



6L DUAL FLUSHING



COMPATIBLE WITH 4.5L DUAL



3L DUAL FLUSHING

HIDDEN FIXATIONS

## TECHNICAL INFORMATION



WARM AIR DRYER



FEMININE WASH



REAR WASH



2 MEMORY SETTINGS



WATER PRESSURE ADJUSTMENT



NOZZLE POSITION ADJUSTMENT



WATER TEMPERATURE ADJUSTMENT



NIGHT LIGHT IN 5 COLORS



NOZZLE AUTO-CLEANING



CHILD MODE



AUTOMATIC MODE



SUPER ECO MODE



8 CM THICKNESS



FIXATIONS INCLUDED



WALL ANCHORING INCLUDED

## RAK-CLEON

Design, technology and elevated hygiene standards

RAK Ceramics presents RAK-Cleon, the new toilet with integrated bidet functionality that brings you the finest in personal comfort and cleansing. An all-in-one solution that combines design and technology, to mark a superior hygiene standard in your bathroom.



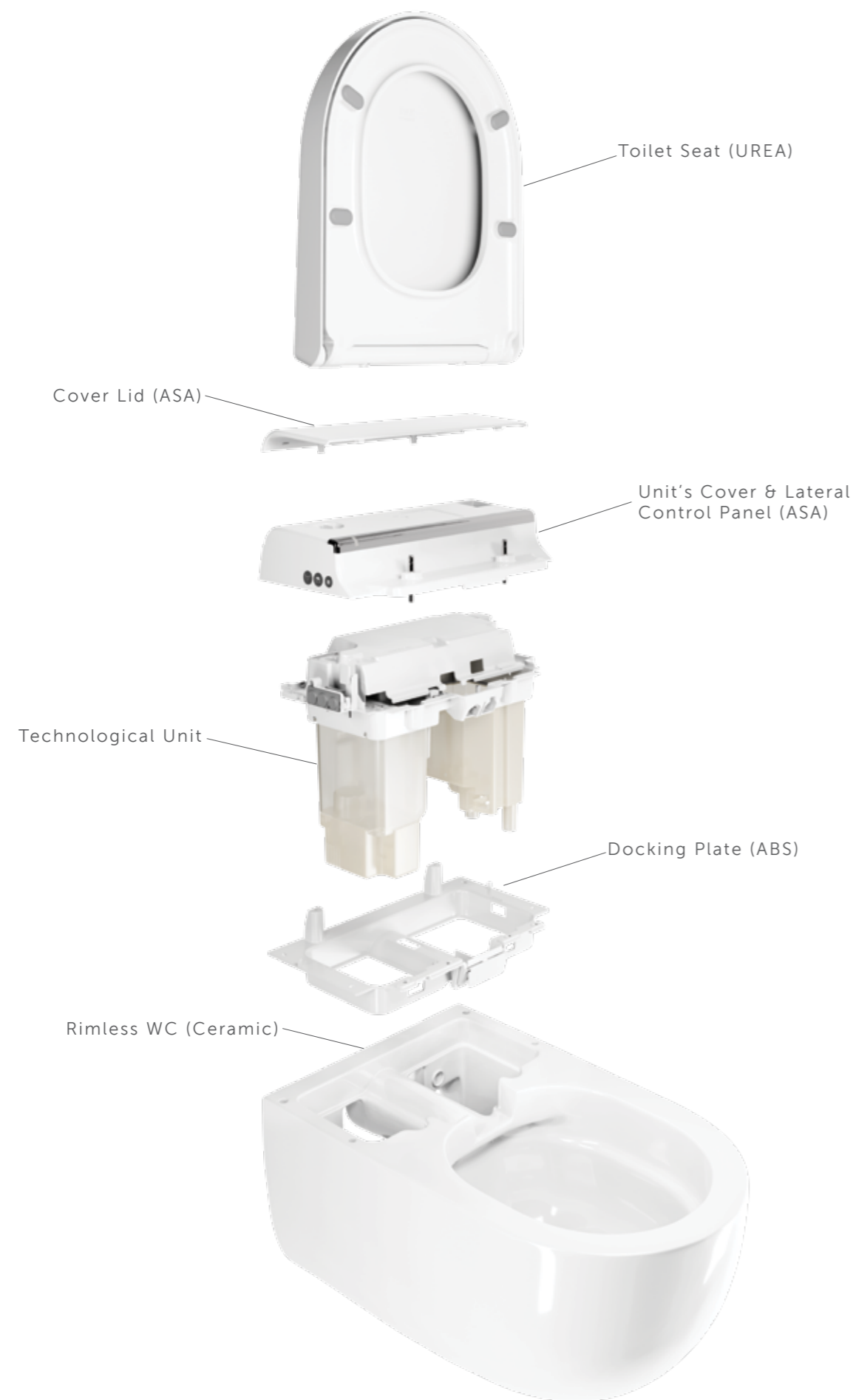

### KEY FEATURES:

- Minimalist design, hidden technology, easy to install
- Flat, hygienic and practical remote control
- Efficient and user friendly: rear wash, feminine wash and warm air dryer
- Pleasant and safe cleansing: water temperature, spray intensity and nozzle position can be individually adjusted and saved
- Night light in 5 colors
- Energy saving mode
- Wide and comfortable seating area
- Urea soft closing seat with quick release

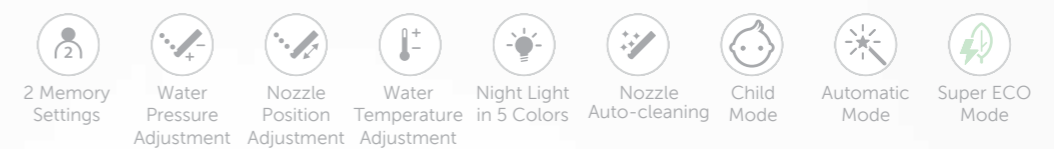



Automatic Descaling Program

User Detection Radar

Urea Seat Cover with Quick Release and Soft Close

Powerful Warm Air Dryer

Basic Control Panel:

- Rear Wash
- Feminine Wash
- Stop

Hidden Fixations

Hidden Water and Electric Supply

LED Night Light in 5 colors



Rimless WC with RAK-ProTek ceramic glaze

Radar User Detection



Large Comfortable Seating Area



**99.9% Antibacterial & Hygiene Glaze**

**Standard Glaze**  
Microscopic view

**RAK-ProTeK**  
Microscopic view

Bacteria  
Silver Ions  
Ceramic

**Standard Glaze**  
Microscopic view

**RAK-ProTeK**  
Microscopic view

Ceramic

## A new standard for hygiene

RAK-ProTeK is the innovative ceramic glaze developed to protect wash basins, toilets and urinals, to make them more hygienic and easier to clean. RAK-ProTeK, which is baked into the ceramic during firing, results to a smoother surface, unlike standard ceramic with irregular surface.

This feature allows the particles accumulating on the ceramic to easily slip away making cleaning more efficient and convenient.

This glaze is an innovative protection against bacteria, the silver ions contained in this revolutionary glaze, kill 99.9% of bacteria in 24 hours and prevent the bacterial growth, in comparison to conventional ceramic glazing. RAK-ProTeK has been tested by Artest laboratory from the Italian Ceramic district in Modena.

## Advanced functionalities made easy

RAK-Cleon's remote provides full control at your fingertips, easily and intuitively. While the three main buttons activate the main cleansing functions, the intuitive adjustment knob allows the user to select the preferred water pressure and nozzle position. All other cleansing functions appear to the user only if the RAK Ceramics logo is tapped, allowing a more advanced experience.

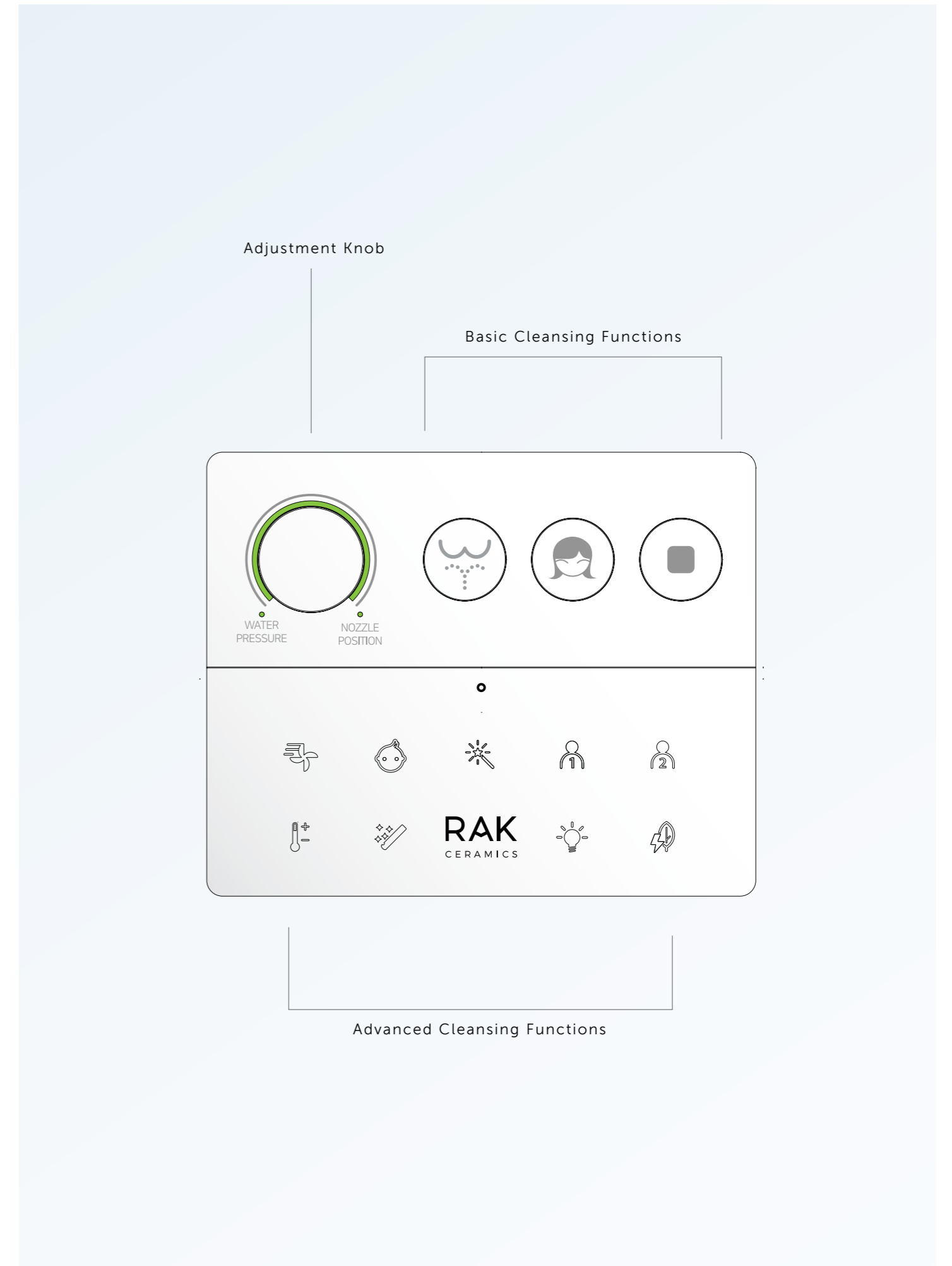



# BASIC CLEANSING FUNCTIONS

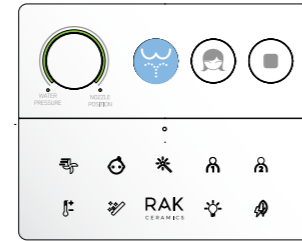

## REAR WASH

Pleasant and reliable cleansing. Water temperature, water spray intensity and the spray wand position can be individually adjusted. The spray wand and nozzle are cleaned automatically before and after each use.

Adjustable settings:

- Water temperature (OFF, 33°C, 36°C, 39°C)
- Water flow pressure (5 levels)
- Nozzle position (5 levels)
- Nozzle oscillating movement

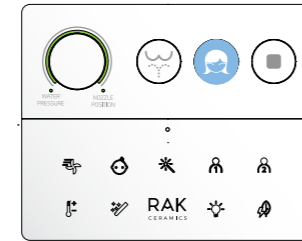

## FEMININE WASH

Specially-developed for the needs of female users. It provides a gentle stream of water for a delicate wash. The spray wand and nozzle are cleaned automatically before and after each use.

Adjustable settings:

- Water temperature (OFF, 33°C, 36°C, 39°C)
- Water flow pressure (5 levels)
- Nozzle position (5 levels)
- Nozzle oscillating movement



## WARM AIR DRYER

The use of the various cleansing functions can be followed by a gentle flow of warm drying air. The temperature and intensity of the warm air dryer can be adjusted. Operating time 180 seconds.

Adjustable settings:

- Air temperature (5 levels)
- Air flow intensity (2 levels)



## STOP

Halts the current activated function.



# ADVANCED CLEANSING FUNCTIONS

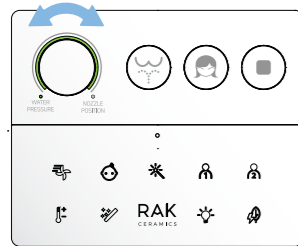

## WATER PRESSURE ADJUSTMENT

The water flow pressure can be intuitively adjusted to 5 different intensity levels through the rotating knob. It adapts to each user's needs, making it a customizable experience.

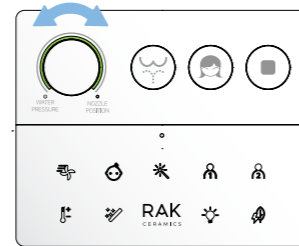

## NOZZLE POSITION ADJUSTMENT

The position of the wand jet can be intuitively adjusted to 5 different levels through the rotating knob. It adapts to each user's needs, making it a customizable experience.



## OSCILLATING MOVEMENT

During rear of feminine cleansing is possible to activate the oscillating mode pressing again the button. The wand jet moves in and out for thorough cleansing over larger areas, for a feeling of ultimate clean.

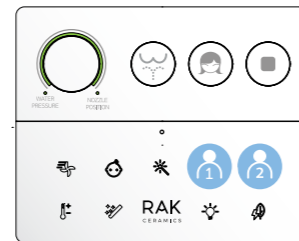

## 2 MEMORY SETTINGS

Personalized experience thanks to exclusive setting for 2 users. Water pressure and exact position of the nozzle can be set to individual preference.

Personal settings:

- Water flow pressure (5 levels)
- Nozzle position (5 levels)

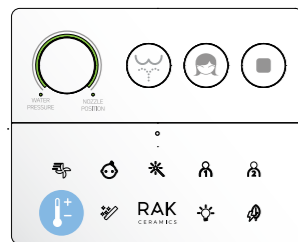

## WATER TEMPERATURE ADJUSTMENT

Pressing the dedicated button on the remote control, allows water temperature adjustment to 3 different ideal levels. Alternatively water heating can be completely turned OFF.

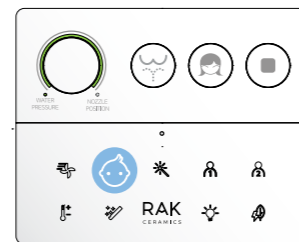
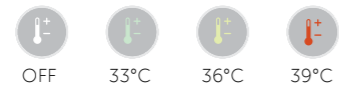

## CHILD MODE

The child mode is a gentle automatic cycle of rear cleansing (40 sec.) and drying (180 sec.) adjusted to children's delicate needs and typical forward sitting position.

Fixed settings:

- Water temperature (as per general setting)
- Water flow pressure (level 1)
- Nozzle position (level 5)
- Air temperature (level 3)
- Air flow intensity (level 1)



## AUTOMATIC MODE

The automatic mode is a standard automatic cycle of rear cleansing (20 sec.) with oscillating movement (20 sec.) and drying (180 sec.) adjusted to standard needs, it is ideal for elder people not familiar with technology.

Fixed settings:

- Water temperature (as per general setting)
- Water flow pressure (level 2)
- Nozzle position (level 3)
- Air temperature (level 3)
- Air flow intensity (level 1)



## AUTO CLEANING NOZZLE

The spray wand and nozzle are cleaned automatically before and after each use, but is possible to run a 30 seconds auto cleaning cycle when desired. To extract the nozzle for a manual cleaning, press the button for 5 seconds.

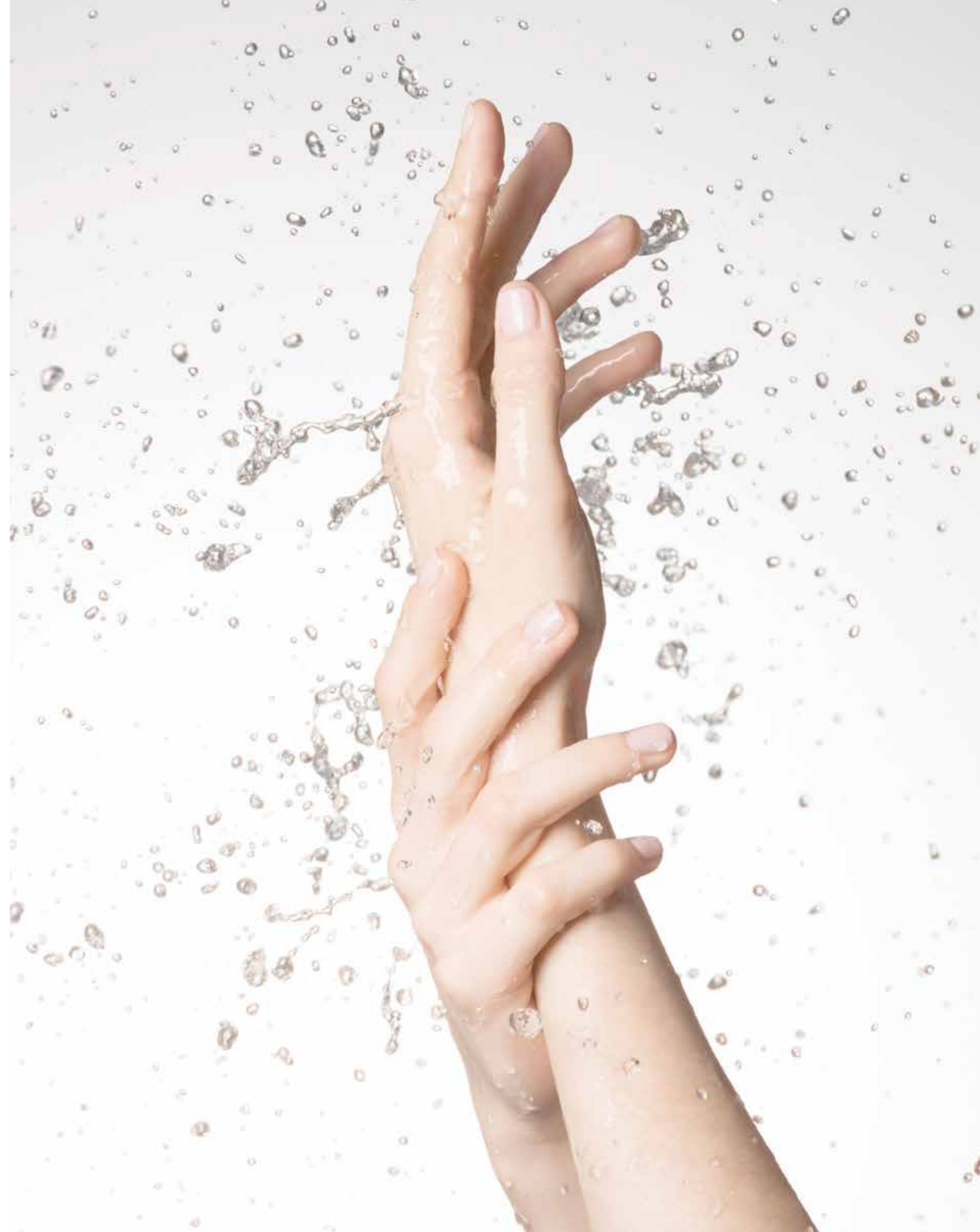



# ECO-FRIENDLY FEATURES



## 3 DIFFERENT ENERGY MODES

To suit your lifestyle RAK-Clean features 3 types of energy saving modes: Super Eco, Eco and Normal. This flexible choice offers benefits in terms of energy saving and environmental policy. RAK Ceramics is constantly involved in the study of new solutions to reduce the amount of energy used, without jeopardizing the product performance.



**SUPER ECO:** unit warms the water only when user is detected.



**ECO:** unit keeps water constantly at 30°C and warms water to operating temperature only when user is detected.



**NORMAL:** unit keeps water constantly at the operating temperature.



## ENERGY SAVER DEFAULT MODE

Nowadays sensitivity towards the environment and energy consumption, is growing. RAK-Clean is set by default to Super Eco Mode and is environmentally friendly: the unit is always ready to use but consuming minimum levels of energy. It activates the water heating only when the radar detects the user in proximity of the toilet, with a very low environmental impact. In normal conditions, once the user is detected, it takes approximately 60 seconds to heat the water to the operating temperature.



## NO CHEMICAL CLEANSERS

The RAK-Clean stainless steel wand is self cleaning, using high pressure warm water jets, therefore it is not necessary the daily use of chemical additives for cleaning. This also makes the system maintenance free, it doesn't require to be filled with chemical substances.



## EFFICIENT CLEANSING

The use of RAK-Clean ensures a more efficient personal hygiene, reducing the use of wet wipes (or similar products) that aren't environmentally friendly.



## LED LIGHTS

The system uses only LED highly energy efficient lighting technology. LED uses at least 75% less energy, and lasts 25 times longer, than incandescent lighting.

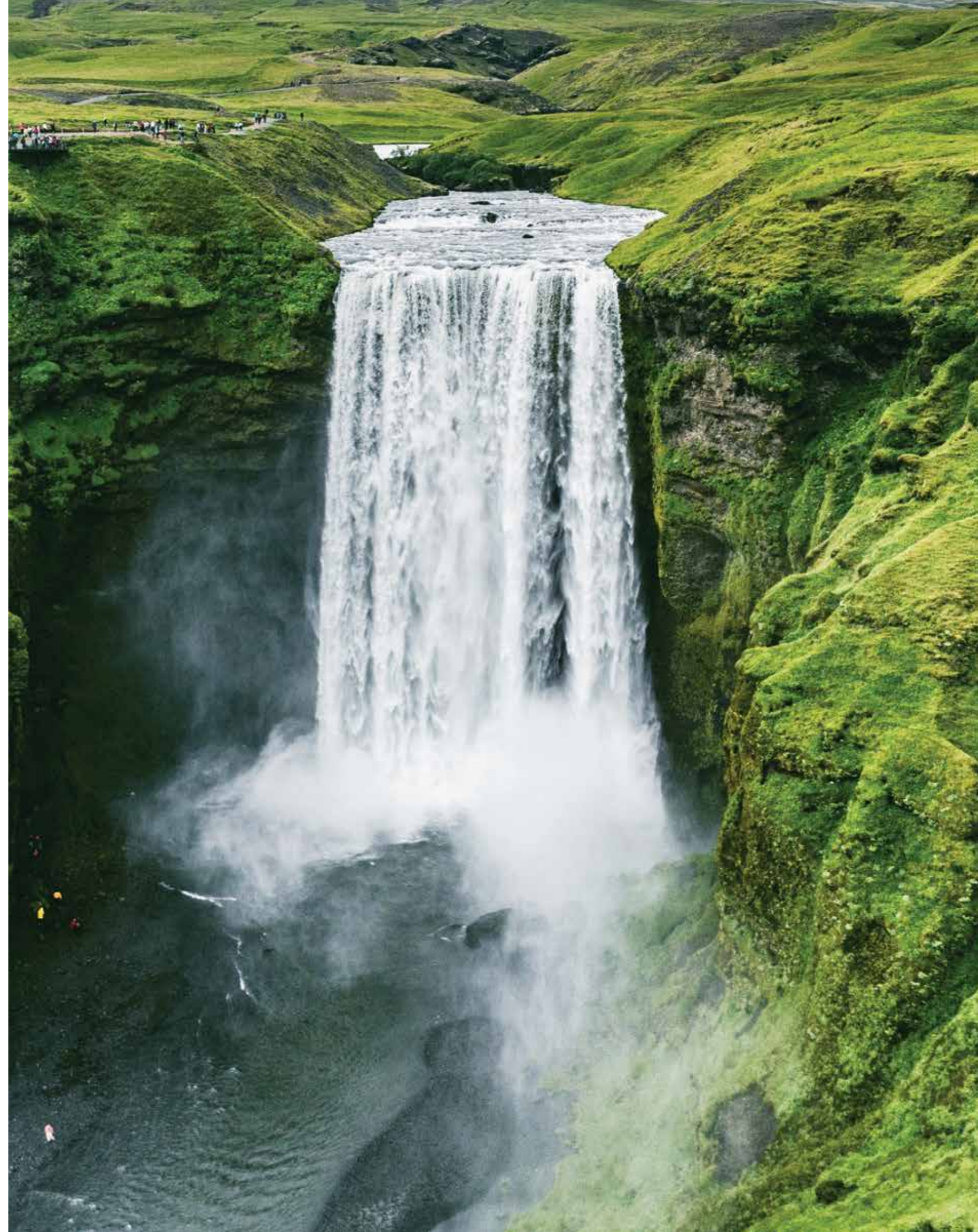



QUICK RELEASE SEAT COVER

Seat cover can be easily detached from the toilet, making it fast and easy to clean all the surrounding area.



NO HIDDEN CREVICES

All areas of RAK-Cleon can be easily reached, there are no hidden crevices making it easy to reach and clean.



WAND CLEANING

The spray wand and nozzle are cleaned automatically before and after each use, but is possible to run a 30 seconds auto cleaning cycle when desired.



WAND EXTRACTION

To extract the nozzle for a deeper manual cleaning, press the button for 5 seconds, the nozzle will remain in fully extended operating position for 180 seconds, with no water emission.



TOILET BASIC FUNCTIONS NEVER COMPROMISED

In case of no electrical power or system failure and consequent need of assistance from RAK Ceramics, the product can continue to be used. RAK-Cleon's basic toilet functions are never compromised: flushing, seating, soft close seat & cover and quick release.



TANK DRAINER PROGRAM

RAK-Cleon's tank (approx. 1,4L) automatically renews the water every 4 days of non-use, in order to ensure always safe and fresh water. In case of longer periods of non-use, it is possible to manually empty the water tank pressing the STOP button for 5 seconds. It takes approximately 2 minutes to complete the operation, afterwards it is recommendable to turn off the power from the main switch placed under the lid.



AUTOMATIC DESCALING PROGRAM

RAK-Cleon is programmed for a periodic automatic limestone removal, depending on the water quality. The water quality is verifiable with the water hardness test included in the product, to do during installation.



# TOILET FEATURES



### SOFT CLOSE AND QUICK RELEASE

Seat cover closes on its own as soon as it is pushed down, it gently and slowly lowers to its closed position. It can be easily detached from the toilet, making it fast and easy to clean all the surrounding area.



### HIDDEN FIXATIONS

Our wall hung and back to wall products are benefitting of the collaboration with Fischer Group, one of the industry leaders. The use of the most innovative Fischer fixing systems, is allowing us design freedom on the ceramic, better aesthetics and more safety for the installer.

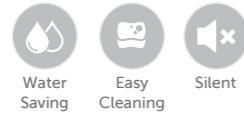

### RIMLESS TECHNOLOGY

RAK-Cleon's RAK Ceramics delivers the ultimate in technology for bathroom suites. Based on similar design specifications to sanitaryware in hospitals and medical centres, RAK Ceramics Rimless water closets allows you to experience the same high standards of hygiene in your own home.

Rimless

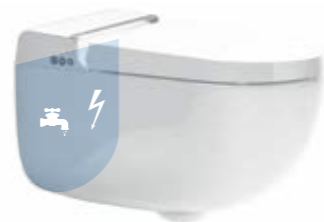

### HIDDEN WATER AND ELECTRIC SUPPLY

The water and electricity supplies are concealed behind the bowl; no cables or flexible hoses are visible on the installed product.

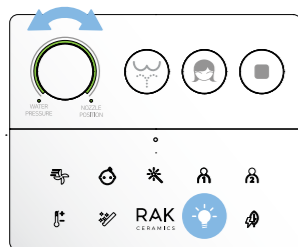

### NIGHT LIGHT

RAK-Cleon's night light can be adjusted to guide the user to the toilet during night time, without needing to switch on the main bathroom light. It provides orientation and safety, without interrupting the body's repose. The LED light can be adjusted to 5 different intensity levels and 5 colors.



BLUE SKY BLUE GREEN VIOLET RED





RAK-CLEON

## RAK-ECOFIX 8CM CONCEALED CISTERN FOR SMART TOILETS

The new RAK-Ecofix concealed cistern for electronic toilets, is the ideal choice for an optimal installation of RAK-Cleon. Prepared for an easy connection of the water and electrical supplies hidden behind the RAK-Cleon ceramic profile, it is suitable for any construction situation. The frame features top level quality standards and innovative solutions. Easy tool free maintenance can be performed at any time, through the service opening behind the push plate.



WATER CONNECTION FOR RAK-CLEON



ELECTRICAL CONNECTION FOR RAK-CLEON



WITHSTANDING HEAVY LOAD



EASY TO CLEAN



COMPATIBLE WITH 4.5L DUAL FLUSHING



WATER SAVING



TOP QUALITY



CISTERN CE TESTED, INSULATED AGAINST CONDENSATION



ADJUSTABLE FEET



**FSRAKPPL009**  
ABS + GLASS White



**FSRAKPPL011**  
ABS + GLASS White



**FSRAKPPL010**  
ABS + GLASS Black



**FSRAKPPL012**  
ABS + GLASS Black



**FSRAKPPL004**  
ABS Chrome



**FSRAKPPL007**  
ABS Chrome



**FSRAKPPL005**  
ABS Matt chrome

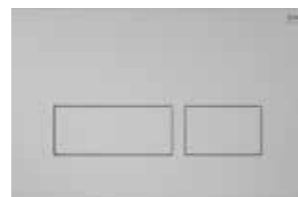

**FSRAKPPL008**  
ABS Matt chrome

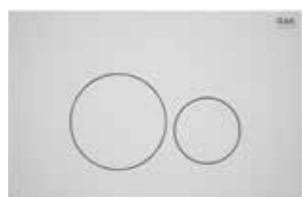

**FSRAKPPL003500**  
ABS White

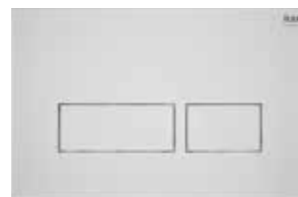

**FSRAKPPL006500**  
ABS White

Models



**SMART TOILET UNIT**  
CLETU0001

Remote Control Included



**62 CM**  
CLEWC1448AWHA

Hidden Fixations



**CLESC3902WH**

With electrical & water connection for smart toilets



**8 CM**  
CLEFS04RAK8C

With electrical & water connection for smart toilets

Measurements

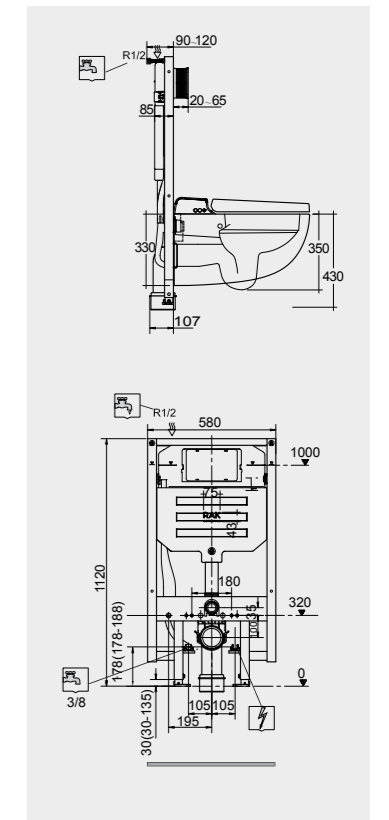
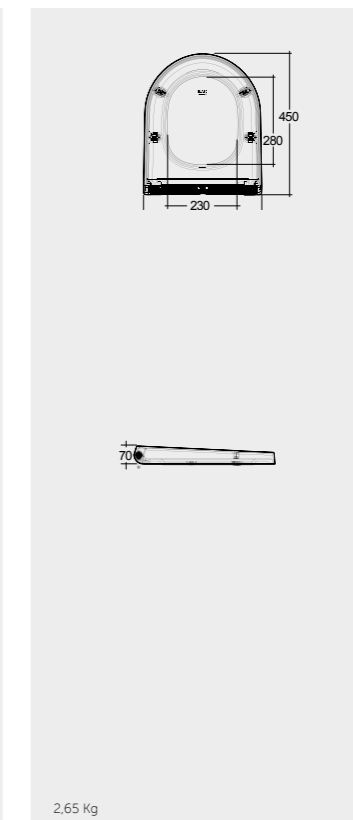
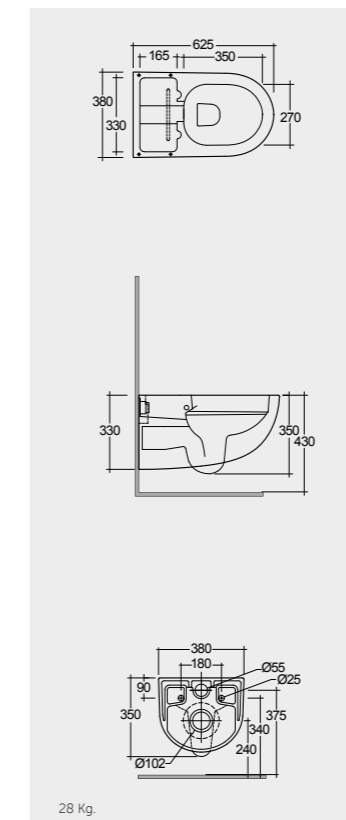
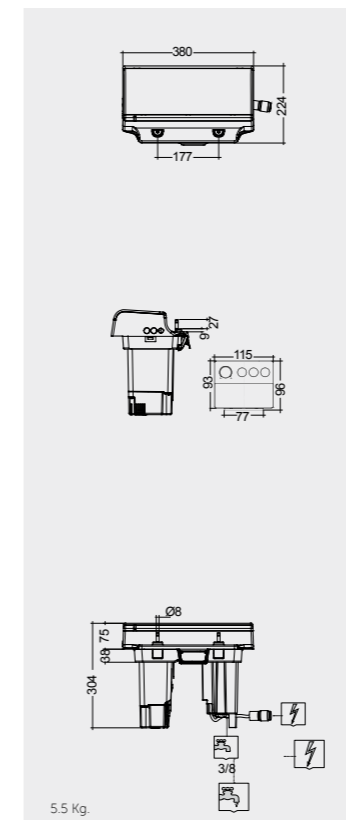

Note

All dimensions in mm tolerance  $\pm 5\%$  for below 200mm and  $\pm 3\%$  for above 200mm

RAK CERAMICS  
P.O. Box 4714, Ras Al Khaimah,  
United Arab Emirates (U.A.E.)  
Tel.: +971 7 2467000  
Fax: +971 7 2445270  
Email: info@rakceramics.com

---

**RAKCERAMICS.COM**

---



**RAK**  
CERAMICS