

### 虹吸式连体坐便器安装说明书

#### 一、安装环境

1. 安装前卫生间墙、地面应已完成施工，且预留了坑管和给水管路；
2. 安装前检查购买产品的规格尺寸是否与所预留的孔眼、管道位置相吻合；
3. 如果有旧的坐便器，应在关闭水源后，再拆除旧坐便器并清洁地面。如果是新安装坐便器，请关闭水源并清洁地面；
4. 进水水压要求：0.8MPa ≥ 进水压力 ≥ 0.02MPa。

#### 二、顾客须知

1. 请确认地下排水管不含存水弯，如含有存水弯，请先将排水管更换为直排或将坐便器更换为直冲式的再进行安装，对所有因地下排水管含存水弯而导致的坐便器功能异常，由客户自行处理；
2. 禁止使用任何形式的水泥安装坐便器，否则坐便器有开裂的可能，对所有因水泥安装所造成的损失由客户负责；
3. 如果不马上安装新坐便器，请用干净的物品堵住坑管下水口，以防水泥、油灰等杂物掉落在坑内，堵塞管路；
4. 安装进水阀前请先对进水管进行冲洗，将水管内的污垢排完，防止进水阀堵塞；
5. 盖板安装详细请参考盖板说明书；
6. 产品无地脚螺丝安装位则不配放地脚螺丝配件包，敬请知悉。

#### 三、注意事项

1. 请不要向坐便器内冲入新闻纸、纸尿裤、妇用卫生巾等易堵的物品；
2. 请不要用重力撞击陶瓷体，以防止破损漏水；
3. 请不要在0℃以下环境中使用；
4. 我公司对因施工、安装或使用不当造成的损失不予赔偿。

#### 四、安装工具

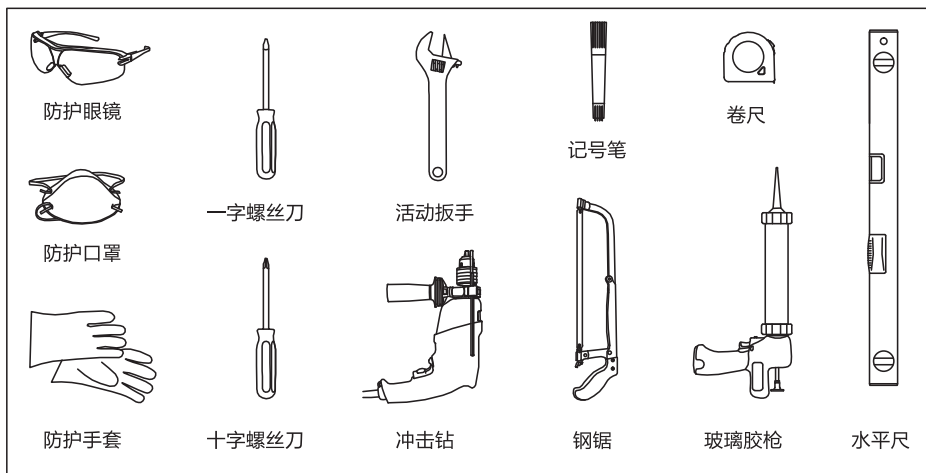

#### 五、安装尺寸示意图

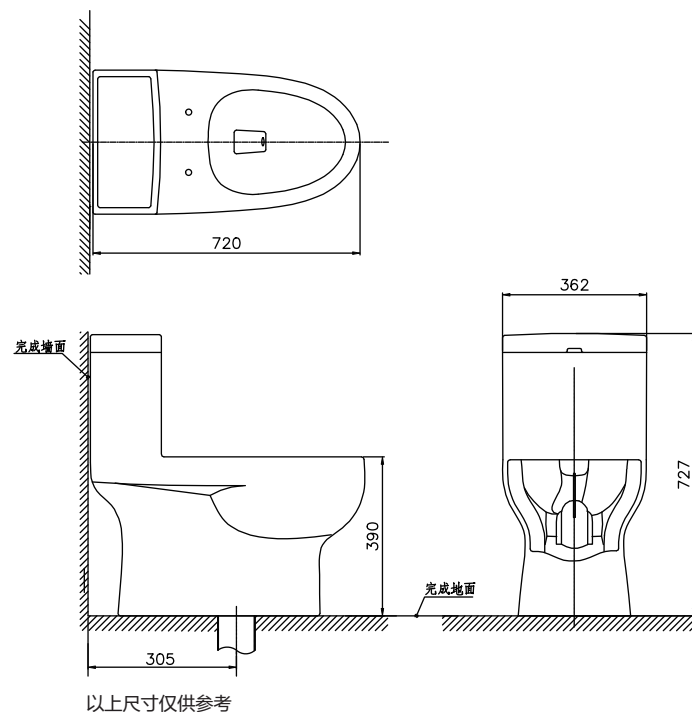

#### 六、安装配件清单

编号	名称	数量	略图	备注
1	连体坐便器	1套		随附
2	防伪码	1张		已粘贴
3	专利标贴	1张		已粘贴
4	合格证	1张		随附
5	水件配件	1套		已安装
6	水效标识贴纸	1张		已粘贴
7	密封圈	1个		随附
8	盖板	1套		另购

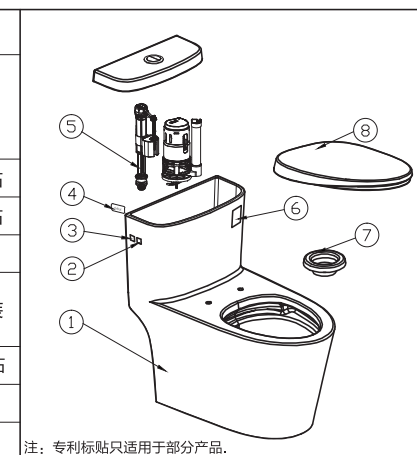

### 七、安装步骤

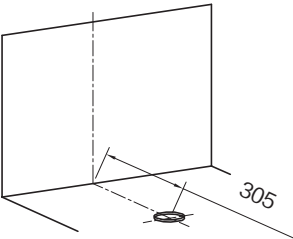
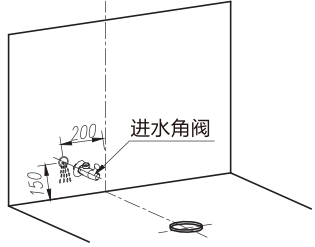
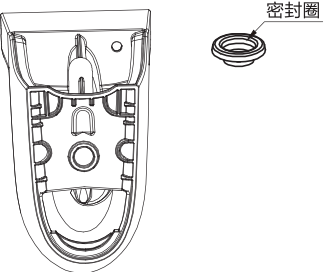
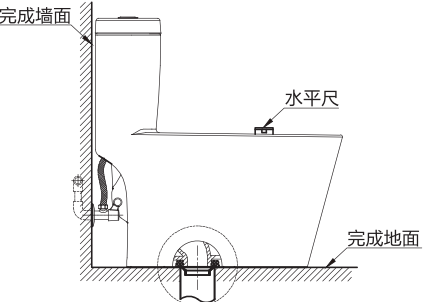
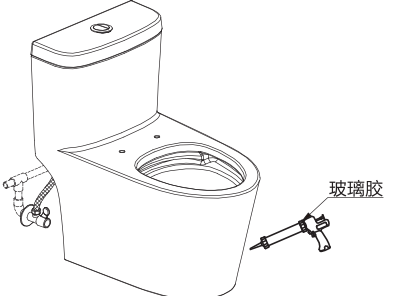
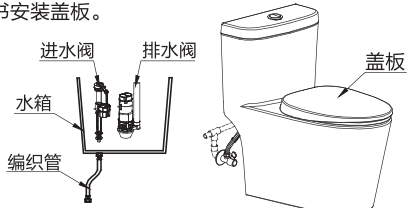
<p><b>1、确定排污孔位置</b> 如果有旧坐便器，应先关掉水源，取下进水角阀，移开旧坐便器。 如果是新安装坐便器，安装前先关掉水源，检查其排污孔的位置，确保其坑距与您所购买的坐便器一致。</p>  <p>管道比完成地面要高于3-5 mm</p>	<p><b>2、确定进水角阀安装位置</b> 如图所示在墙面相应位置预留进水孔，旋入进水角阀顺时针将其拧紧。建议角阀的接口朝正上方。 注：安装进水角阀之前请先放水将管道内杂质排干净。</p> 
<p><b>3、安装密封圈</b> 如图所示：倒置坐便器于软垫上，平稳后将密封圈紧套于坐便器排污口处。</p> 	<p><b>4、放置坐便器</b> 密封圈装好后倒回并垫高坐便器(防止压到密封圈)，慢慢放下坐便器，确保密封圈与地面排污孔对正后，轻微摇摆下压坐便器直至达到水平。</p> 
<p><b>5、检查坐便器安装</b> 确保坐便器没有问题后，盖水箱盖。沿坐便器底部周围挤入玻璃胶，再抹去溢出部分。</p> 	<p><b>6、坐便器试水和安装盖板</b> 试水前先冲洗进水管，再接通水源检查进水阀进水及密封是否正常、排水阀与安装位置是否相互对应、安装是否紧密、有无渗漏、按钮开关链条长短是否合适、开关是否灵活、有无机会卡堵及有无漏装进水阀过滤装置。检查完毕后，参考盖板说明书安装盖板。</p> 

### 八、故障处理

常见故障	故障原因	故障排除方法
水位太高或太低	进水阀水位没调整好	重新调节水位
进水阀不止水	1.进水阀浮桶受阻没有浮到位 2.补水管安装不正确 3.排水阀漏水 4.进水阀水位超过排水阀溢流管	1.检查浮桶是否卡涩，能不能上下浮动自如 2.按附图要求将补水管安装正确 3.确认排水阀没有漏水 4.重新调整进水阀水位及安装高度
进水阀不进水	1.进水开关没打开 2.进水阀浮桶受阻没有落到位 3.过滤网受水质影响而堵塞	1.打开进水开关 2.检查浮桶是否卡涩，能不能上下浮动自如 3.清洗过滤器
按下按钮不排水或排水太少	1.压杆太短 2.半排浮桶过高	1.重新调整 2.重新调整
排水阀漏水	1.压杆过长 2.水质影响，拆出阀体清洗 3.底座未装好	1.剪除一部分压杆重新调整 2.拆开阀体与底座重新装配 3.重新安装锁紧

### Installation Instructions

#### 1. INSTALLATION ENVIRONMENT

1. Finished wall and finished floor are required before installation. Reserved space for all holes, pipes and water supply lines.
2. Before installation, make sure that the specifications of this product conform to the position of reserved holes and pipes.
3. Remove old toilet if there is an existing one after shutting off water supply and clean floor. For installing a new toilet, shut off water supply and clean floor.
4. Requirement for inlet water pressure: 0.8MPa ≥ inlet water pressure ≥ 0.02MPa.

#### 2. IMPORTANT

1. Make sure there is no drain trap. If there is a drain trap, replace it with a direct drain pipe or purchase a washdown type toilet before installation. KARAT will not be responsible for abnormal functions of the toilet due to the presence of drain trap.
2. Do not use any cement to install the toilet. Otherwise, the toilet could crack. All the damage due to cement installation is the responsibility of the installer.
3. If the new toilet is not installed immediately, block the outlet drain hole with clean object to make sure that all connection supply lines are free of foreign materials such as pipe dope, pipe chips which can block the line.
4. Before installing the inlet valve, flush the inlet water line and discharge dirt in it in case of blockage of the inlet valve.
5. To install the toilet seat, read the specific installation instructions for the seat.
6. This product will not include bolt accessory pack if there is no position for bolts on the product.

#### 3. CAUTION

1. Do not flush objects that very possibly cause blockage, such as newspaper, diapers, sanitary pads for women, etc.
2. Do not strike the ceramic with a heavy force, so as to prevent the toilet from damage and water leakage
3. Do not use the toilet in an environment below 0°C.
4. The manufacturer will not be responsible for damage caused by incorrect construction, installation or use.

#### 4. RECOMMENDED TOOLS AND MATERIALS FOR INSTALLATION

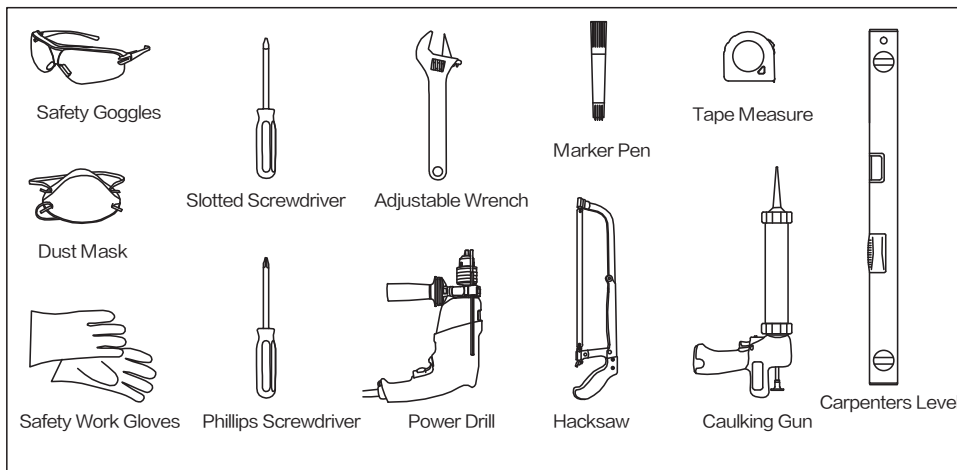

#### 5. ROUGHING-IN DIMENSIONS

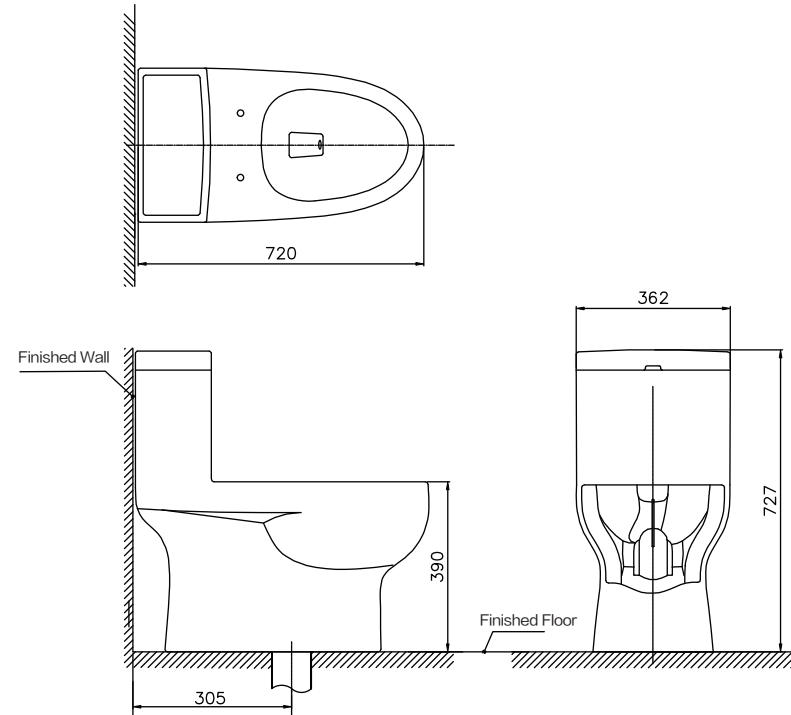



The dimensions above are just for reference.

#### 6. LIST OF ACCESSORIES

Serial Number	Product Name	Number	Contracted drawing	Remark
1	One-piece toilet	1 Item		
2	Fill valve accessory	1 Set		Supplied
3	Wax ring	1 Item		Supplied
4	Toilet seat	1 Set		Supplied

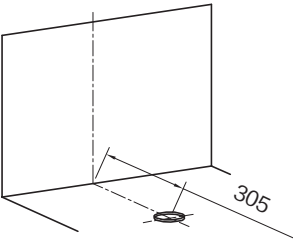
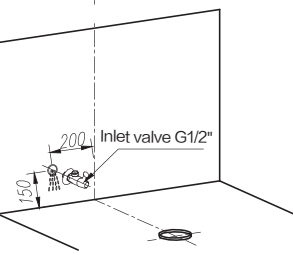
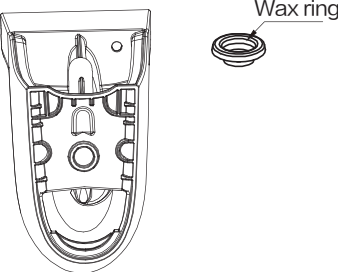
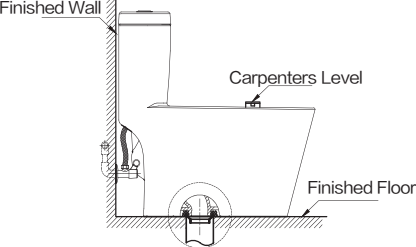
### 7. INSTALLATION INSTRUCTIONS

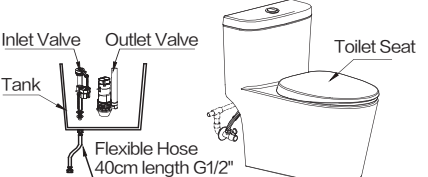
<p><b>1 Mark the position of waste flange</b></p> <p>If there is an old toilet, shut off water supply and take off inlet valve and then remove old toilet . For installing a new toilet, shut off water supply and check the position of waste flange. Make sure that the rough-in distance conforms to the purchased product.</p>  <p>Outlet pipe 3-5mm higher than finished floor</p>	<p><b>2 Mark mounting position for inlet valve</b></p> <p>Reserve an inlet hole on wall as illustrated below. Screw inlet valve clockwise. It is suggested that inlet valve joint should face the direct above. Note: Inlet water line should be flushed and free of any impurities before installing inlet valve.</p>  <p>Inlet valve G1/2"</p>
<p><b>3 Install wax ring</b></p> <p>Invert toilet evenly on floor (cushion to prevent damage), and install wax ring around waste flange as illustrated below.</p>  <p>Wax ring</p>	<p><b>4 Install toilet</b></p> <p>After installing wax ring, position toilet on flange; with cushion, set toilet higher than floor to avoid pressing wax ring. Slowly position toilet on flange. Make sure that wax ring docks with waste flange. With a rocking motion, press bowl down fully on wax ring and flange until toilet is level.</p>  <p>Finished Wall</p> <p>Carpenters Level</p> <p>Finished Floor</p>
<p><b>5 Check toilet installation</b></p> <p>Set the cover onto tank after checking toilet. Apply sealant around toilet base and remove excess sealant.</p>  <p>Sealant</p>	<p><b>6 Flush test and install toilet seat</b></p> <p>Flush the inlet water line before testing. Connect water supply and check inlet valve and wax ring. Check the position and tightness of flush valve. Check whether there is water leakage. Check the length of flush valve chain and flush button. Check whether there is a blockage and make sure the inlet valve has a filter. After checking, install toilet seat in accordance with manufacturer's directions.</p>  <p>Inlet Valve</p> <p>Outlet Valve</p> <p>Tank</p> <p>Flexible Hose 40cm length G1/2"</p> <p>Toilet Seat</p>

### 8. TROUBLESHOOTING

Problem	Possible Cause	Solution
Water level too high/too low.	Incorrect water level in inlet valve.	Readjust water level.
Inlet valve continues to flow.	<ol style="list-style-type: none"> <li>1. Float cup not in right position.</li> <li>2. Incorrect installation of the fill valve.</li> <li>3. Water leakage in outlet valve.</li> <li>4. Water level of inlet valve is higher than outlet pipe.</li> </ol>	<ol style="list-style-type: none"> <li>1. Set float cup tightly in the right position and check whether it can function properly.</li> <li>2. Correctly install the fill valve as illustrated.</li> <li>3. Stop water leakage of outlet valve.</li> <li>4. Readjust water level and installation position of inlet valve.</li> </ol>
Inlet valve does not flow.	<ol style="list-style-type: none"> <li>1. Inlet valve does not switch on.</li> <li>2. Float cup not in the right position.</li> <li>3. Filter blockage affected by water quality.</li> </ol>	<ol style="list-style-type: none"> <li>1. Switch on the inlet valve.</li> <li>2. Set float valve tightly in the right position and check whether it can function properly.</li> <li>3. Clean filter.</li> </ol>
No flush or poor rim flush.	<ol style="list-style-type: none"> <li>1. Trip level rope too short.</li> <li>2. Float cup installed too high.</li> </ol>	<ol style="list-style-type: none"> <li>1. Readjust trip level rope.</li> <li>2. Readjust float cup position.</li> </ol>
Water leakage of flush valve.	<ol style="list-style-type: none"> <li>1. Trip level rope too long.</li> <li>2. Clean flush valve affected by water quality.</li> <li>3. Incorrect installation of outlet valve base.</li> </ol>	<ol style="list-style-type: none"> <li>1. Cut part of rope and readjust.</li> <li>2. Disassemble flush valve. Reassemble.</li> <li>3. Reinstall and tighten.</li> </ol>

卡丽 KARAT®

安装说明书

INSTALLATION  
INSTRUCTION

MAGNOLIA  
ONE-PIECE TOILET  
35395VN-WK