

Overview

Premium Sounding Compact Ceiling Speakers at a Non-Premium Price.

VC series ceiling speakers for commercial installations deliver excellent sound quality at a price point traditionally reserved for economy speakers. A total of six models, three with back cans and three without, feature elegant low-profile designs that can be install easily even in limited ceiling or wall spaces. Large mounting clamps with non-slip treads ensure secure mounting.



Features

- Engineered for optimum BGM and voice reproduction
- No back can low-profile design allows installation in limited ceiling spaces
- Direct support for low-impedance or high-impedance connections
- 16 Ω in low-impedance is advantageous when connecting multiple speakers in low impedance system
- Double-threaded speaker clamp screws for speedy tightening
- Paintable grilles with magnetic catches
- Black and white versions available
- 2.3 kg (5.1 lbs), \varnothing 286 mm x D114 mm (\varnothing 11-2/8" x D4-4/8")
- Single unit package

Specifications

General Specifications

System Type		2way Coaxial type (without backcan)
Components	LF	6.5" Cone
	HF	0.8" Soft dome
Frequency Range (-10 dB)		63 Hz - 20 kHz *1
Coverage Angle (Horizontal x Vertical)		120°conical *1
Nominal Impedance		16 Ω
Transformer Taps	70V	12 W, 6 W, 3 W, 1.5 W
	100V	12 W, 6 W, 3 W
Power Rating	NOISE	25 W
	PGM	50 W
	MAX	100 W
Sensitivity (1 W, 1 m)		89 dB SPL *1
Maximum SPL (Calculated, 1 m)		109 dB SPL *2
Connectors		1 x Push terminal (WAGO 294 /2 pin)
Material, Finish, Color		VC6NB: Black (approx. Munsell N3)
		VC6 NW: White (approx. Munsell N9.3)
Dimensions (W x H x D)		Ø286 mm x D114 mm (Ø11-2/8" x D4-4/8")
Net Weight		2.3 kg (5.1 lbs)
Cutout Size		Ø247 mm (Ø9-3/4")
Required Ceiling Board Thickness		2 mm - 37 mm
Packaging		Single
Certificate		CE, RoHS

*1 Half space (2π)

*2 Calculated based on power rating and sensitivity

Accessories

Included Accessories	C-Ring, Tile Rails x 2, Grille, Safety wire, Cutout template
----------------------	--

Dimensions

Unit: mm

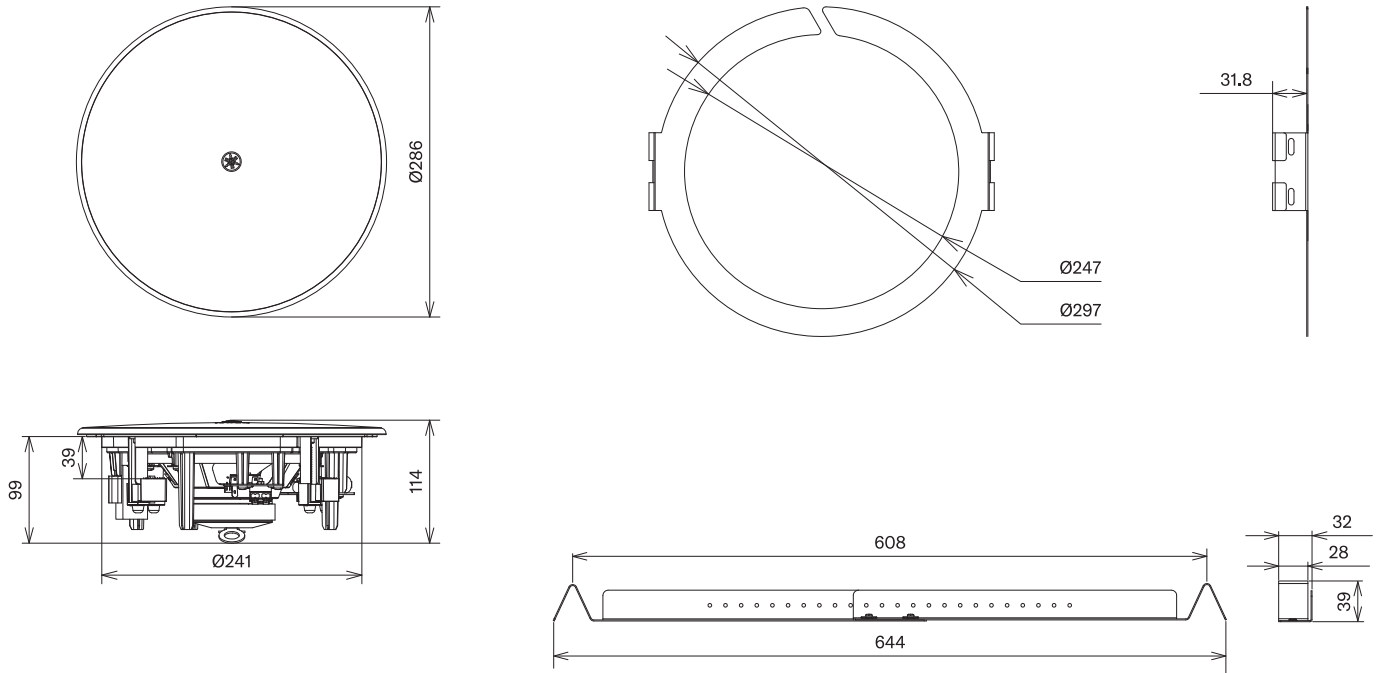

Architectural and Engineering Specifications

The Yamaha VC6NB (black) and VC6NW (white) shall be low-profile flush-mount ceiling speakers designed for commercial installations. The VC6NB and VC6NW shall have a 6.5" cone low frequency driver and 0.8" soft dome high frequency driver.

The VC6NB and VC6NW shall meet the following performance criteria: Sensitivity shall be 89 dB SPL at 1 watt/1 meter, maximum SPL shall be 109 dB at 1 meter, frequency response shall be 63 Hz to 20 kHz at 10 dB below rated sensitivity, and nominal coverage angle shall be 120° conical. Maximum power ratings shall be 25 watts noise, 50 watts program, and 100 watts peak. A tap selector shall be provided to allow operation at 16 ohms in low-impedance systems, or 70V/100V line voltage in distributed systems. 3, 6, and 12 watt power taps shall be provided for 100 volt distributed lines. 1.5, 3, 6, and 12 watt power taps shall be provided for 70 volt distributed lines. Overload protection shall be provided by full-range power limiting. Push terminals shall be provided for input connection.

The VC6NB and VC6NW shall have a powder-coated punched metal grille and ABS trim ring. These models shall not have back cans, but shall be provided with a dust-proof bag made of artificial fiber to protect the back of the speaker. The VC6NB grille and trim ring shall be black, and the VC6NW grille and trim ring shall be white. The VC6NB and VC6NW shall be supplied with a safety wire, cutout template, owner's manual, and a reinforcing bracket kit including tile rails, a C-ring, and screws. The required ceiling cutout size shall be 247 (ø) mm. Speaker dimensions including grille shall be 286 (ø) x 114 (D) mm. Weight shall be 2.3 kg.

Sensitivity

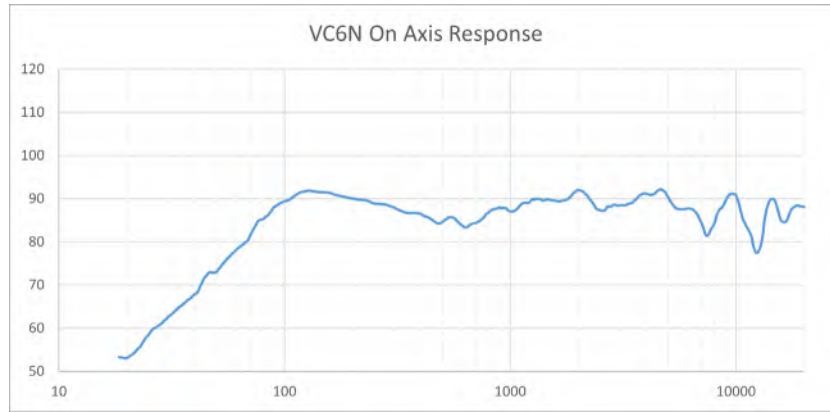

Beam Width

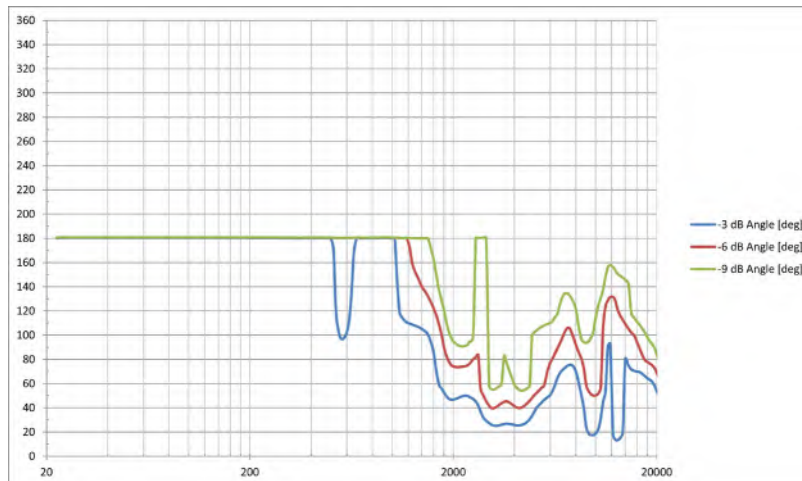

Directivity Index

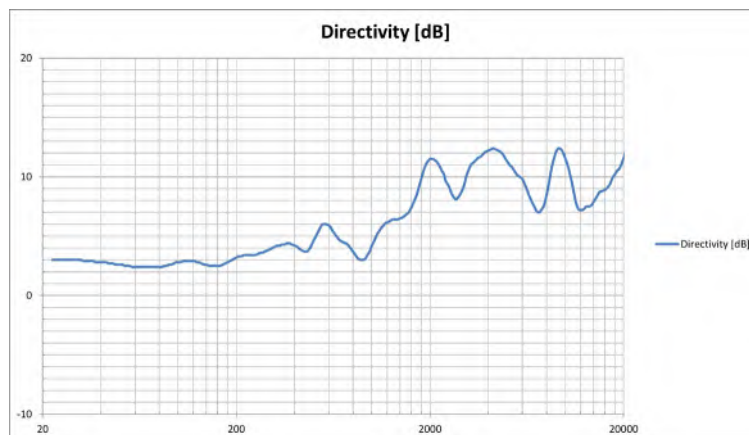

Polar Plots

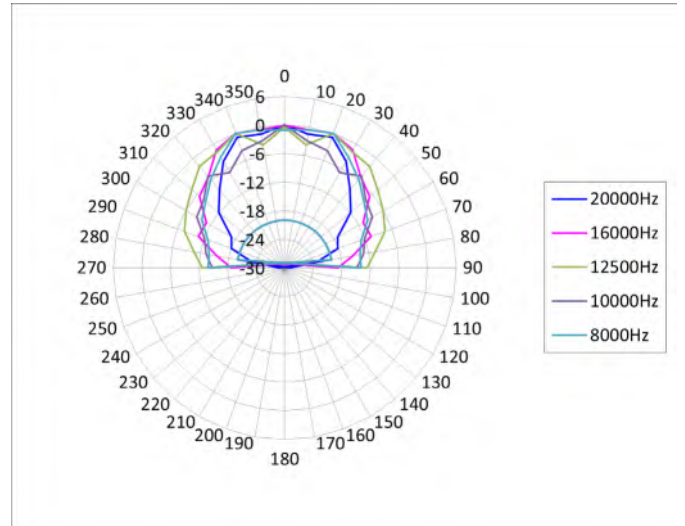
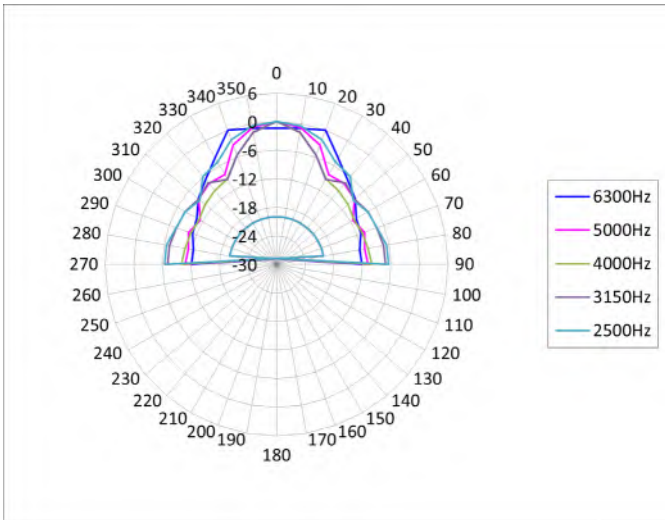
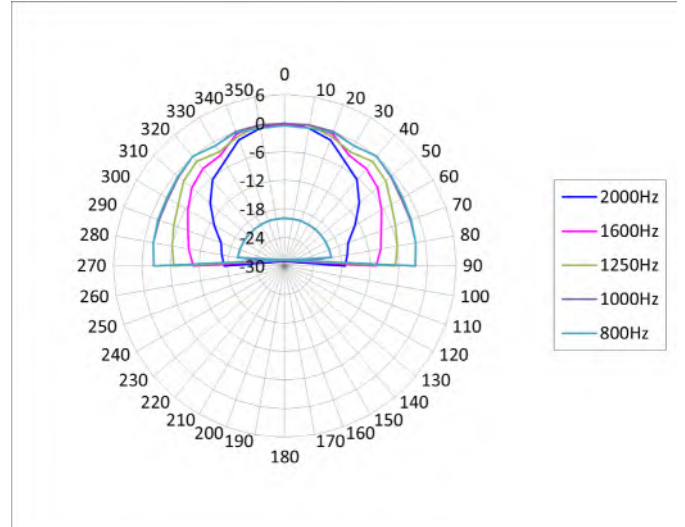
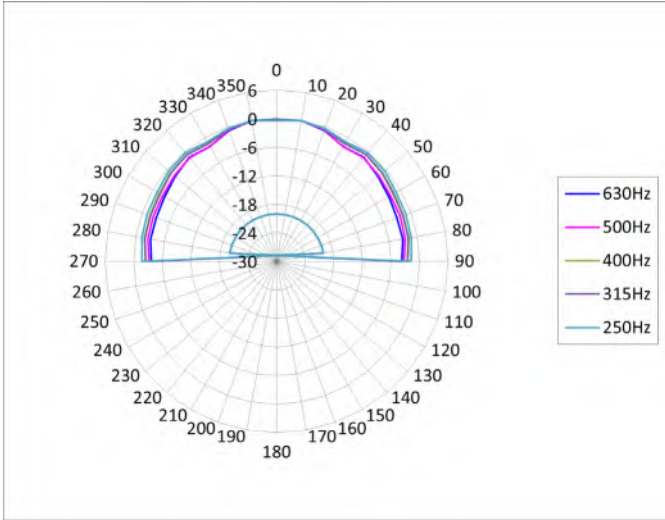

*All information subject to change without notice.

*All trademarks and registered trademarks are property of their respective owners.

Created in May, 2022

YAMAHA CORPORATION
P.O.BOX 1, Hamamatsu Japan
www.yamaha.com/proaudio/