



**PONYZO**

- ĐỘ TUỔI: 1-6 TUỔI
- TỐI ĐA TẢI: <50kg
- THỜI GIAN LẮP RÁP: 30 phút
- CHIỀU CAO GHẾ NGỒI: 20-35cm
- TRỌNG LƯỢNG: 2-3 kg



Scan Me



**PNZ-1122**

**XE LẮP RÁP**

**SÁNG TẠO**

**Cho Bé vận động thông minh**



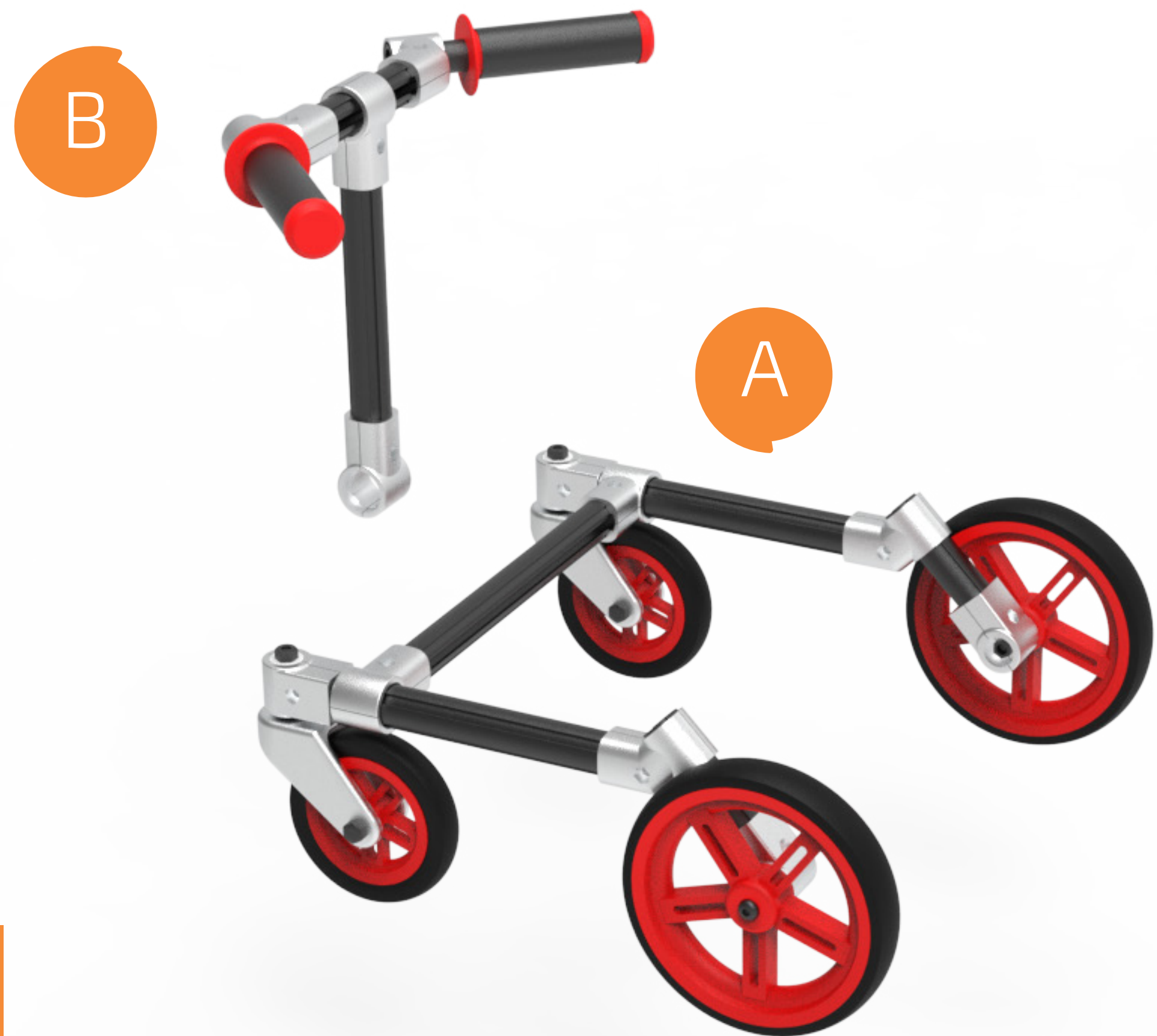

## LẮP RÁP TỪ ĐẦU ĐẾN CUỐI

- Tự mình lắp ráp hoặc 1 nhóm 2 bạn.
- Khi lắp ráp nhóm thì 1 bạn sắp xếp và chuẩn bị các linh kiện, hỗ trợ cho bạn còn lại lắp ráp.
- Có thể thay đổi vai trò của nhau để thêm vui



--- A, B, C, D, E

## CHIA NHỎ CÁC BỘ PHẬN LẮP RÁP

- Khi chúng ta có 2 người hoặc nhiều hơn.
- Chúng ta chia ra lắp ráp các bộ phận riêng biệt.
- Sau đó kết nối các bộ phận lại để hoàn thành sản phẩm.















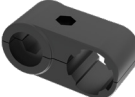













--- A, B

--- C, D

E



## BẢNG PHỤ KIỆN CHI TIẾT

STT	PARTNAME	QTY		STT	PARTNAME	QTY	
1	Khớp nối P1	2		15	Ống D-400		
2	Khớp nối P2			16	Ống D-350		
3	Khớp nối P3	4		17	Ống D-300	1	
4	Khớp nối P3A			18	Ống D-250		
5	Khớp nối P3B			19	Ống D-200	3	
6	Khớp nối P4	4		20	Ống D-150	1	
7	Khớp nối P5			21	Ống D-100	2	
8	Khớp nối P6			22	Ống D-50		
9	Khớp nối P7			23	T1-Tay lái	2	
10	Khớp nối P8			24	Y-Yên xe		
11	Khớp nối P13			25	T2-Cọc yên		
12	W3-Bánh xe Lắc	2		26	S1-Lót chân		
13	W1-Bánh xe 120			27	Hộp linh kiện	1	
14	W2-Bánh xe 200	2					

1

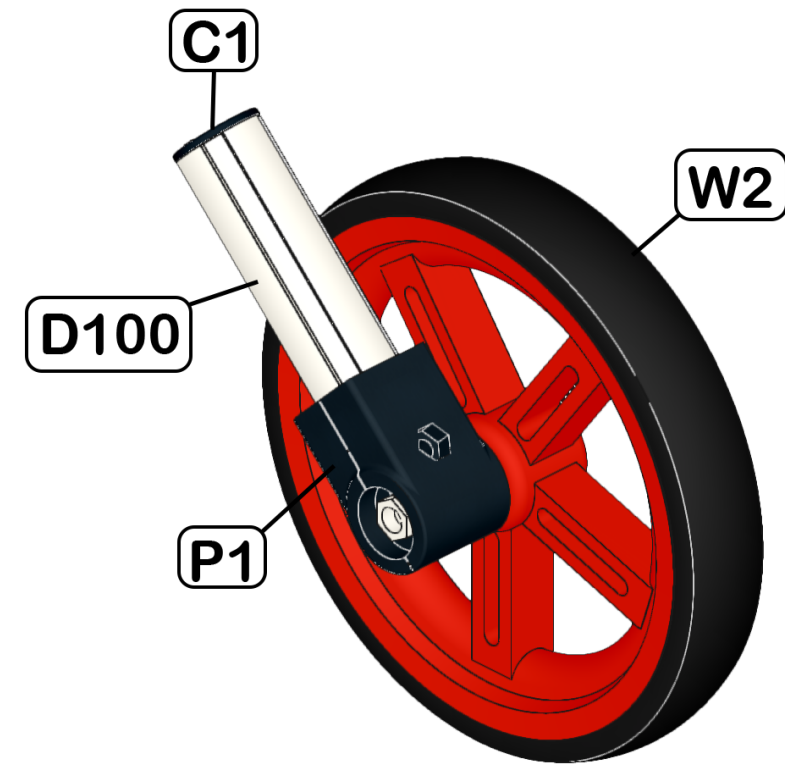

2

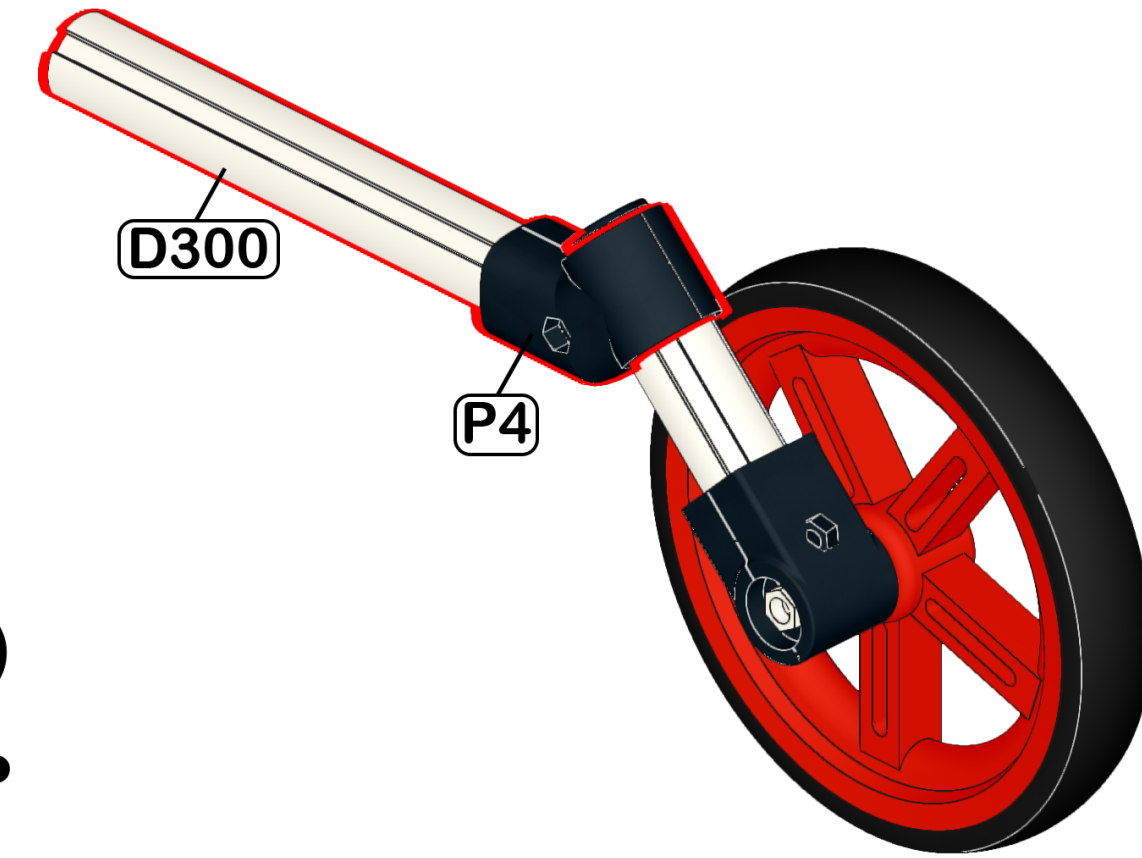

3

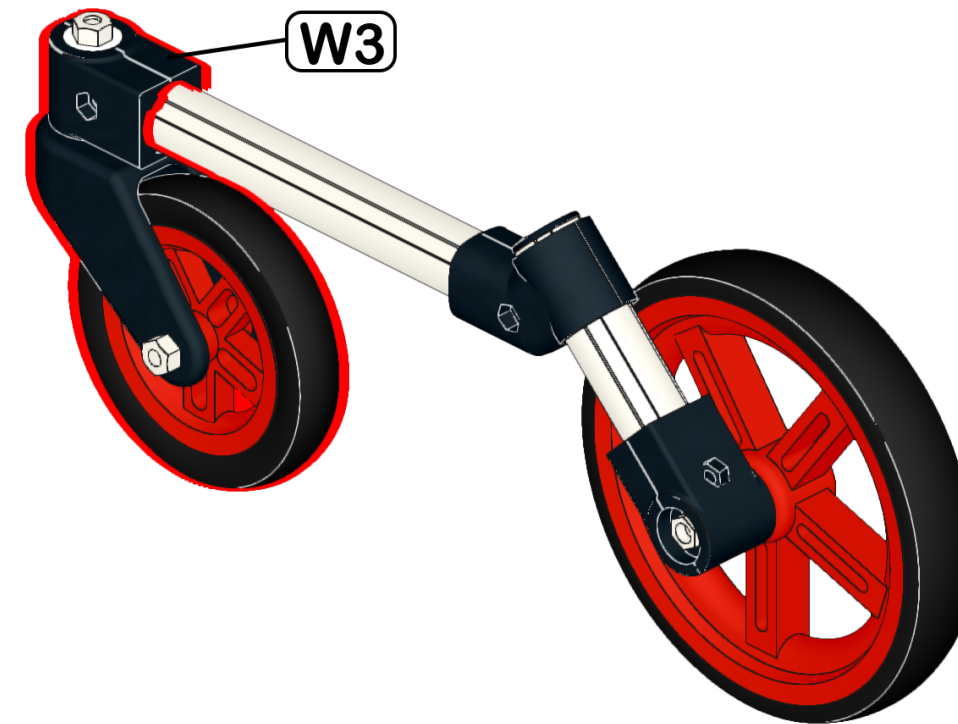

TRANG

< 4 >



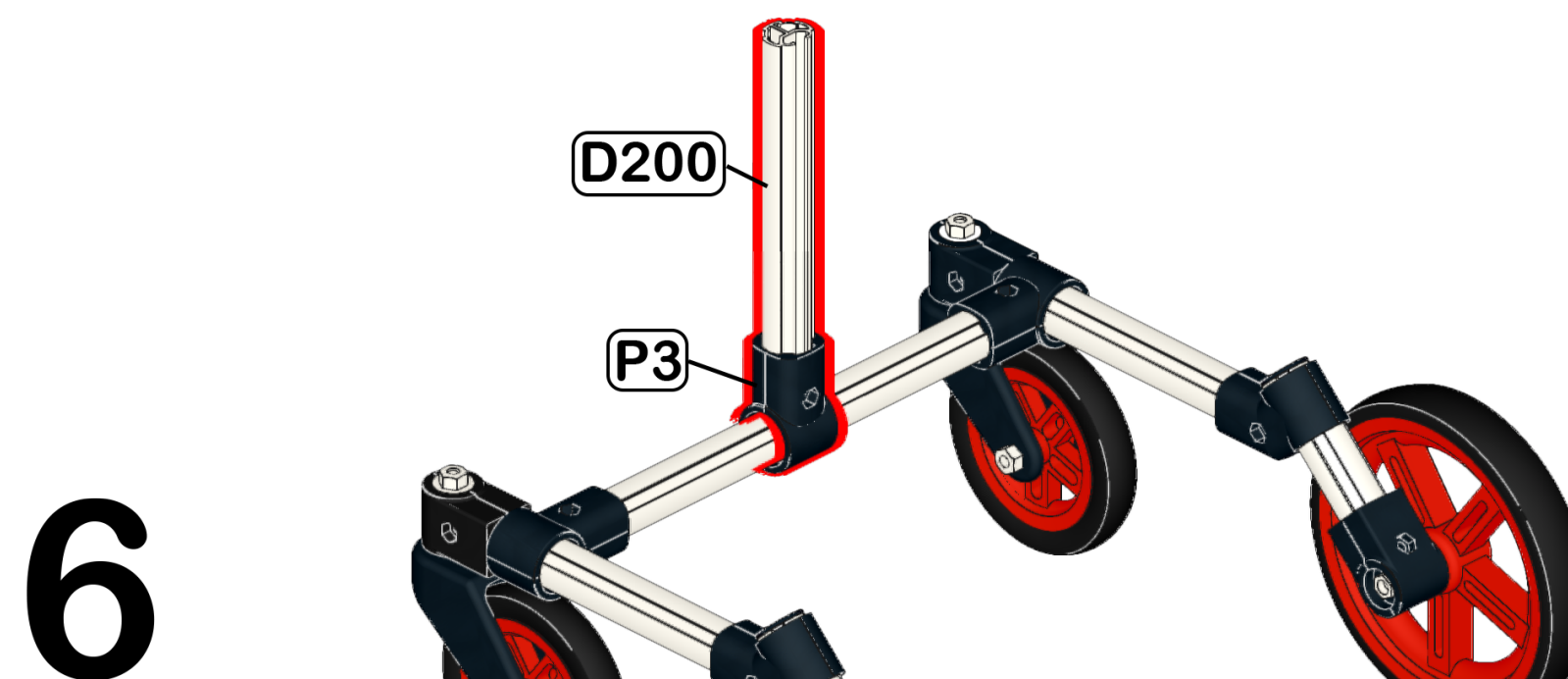
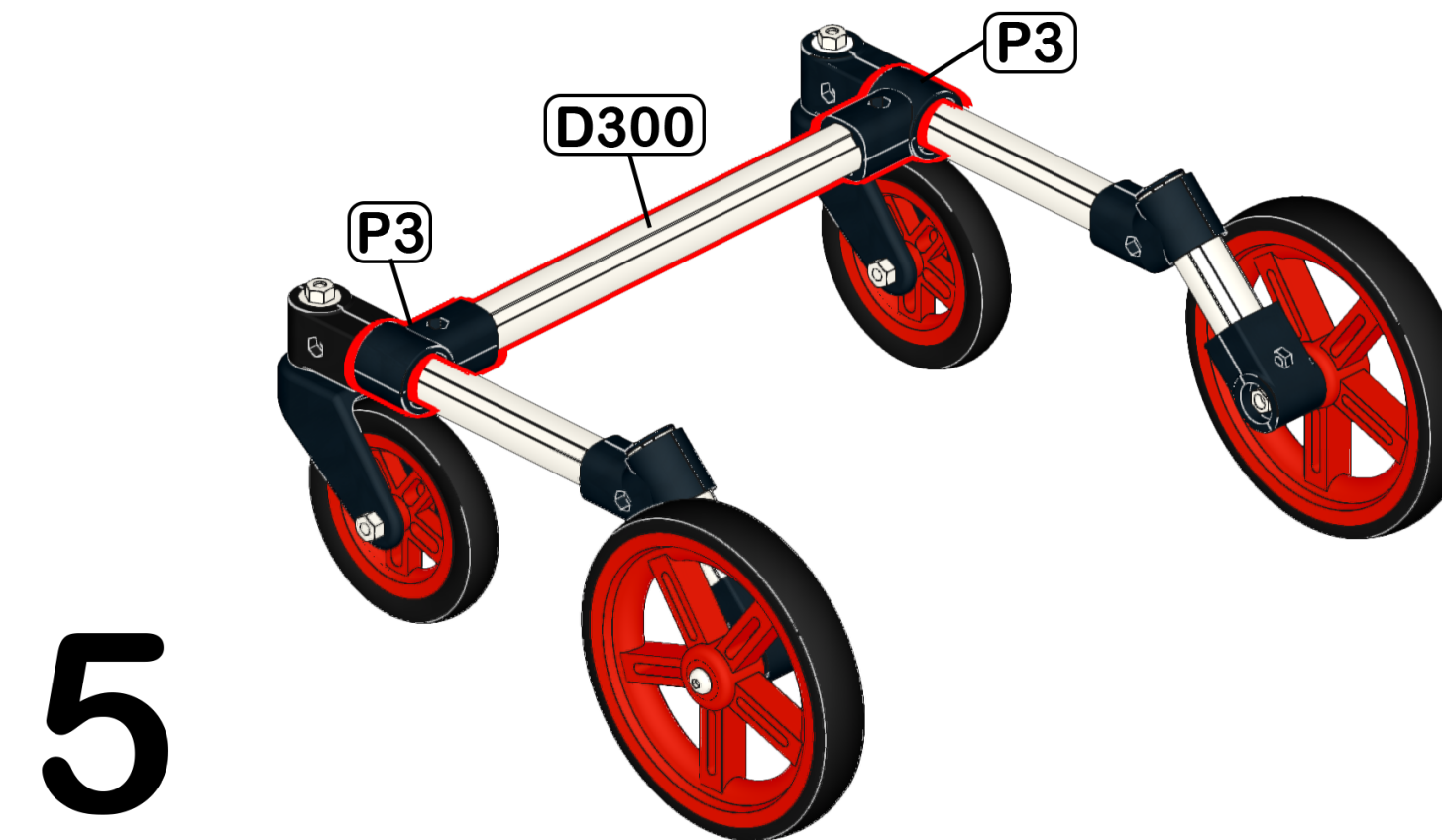
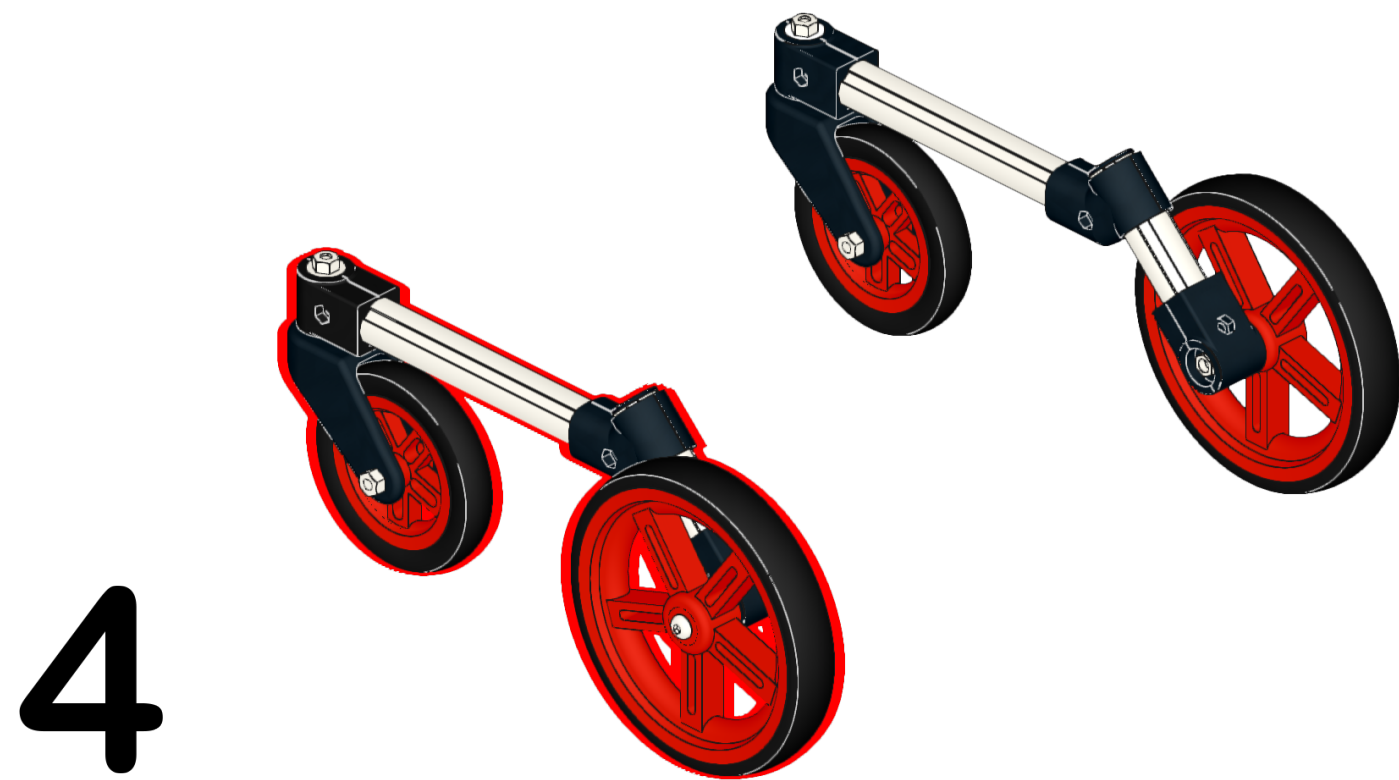

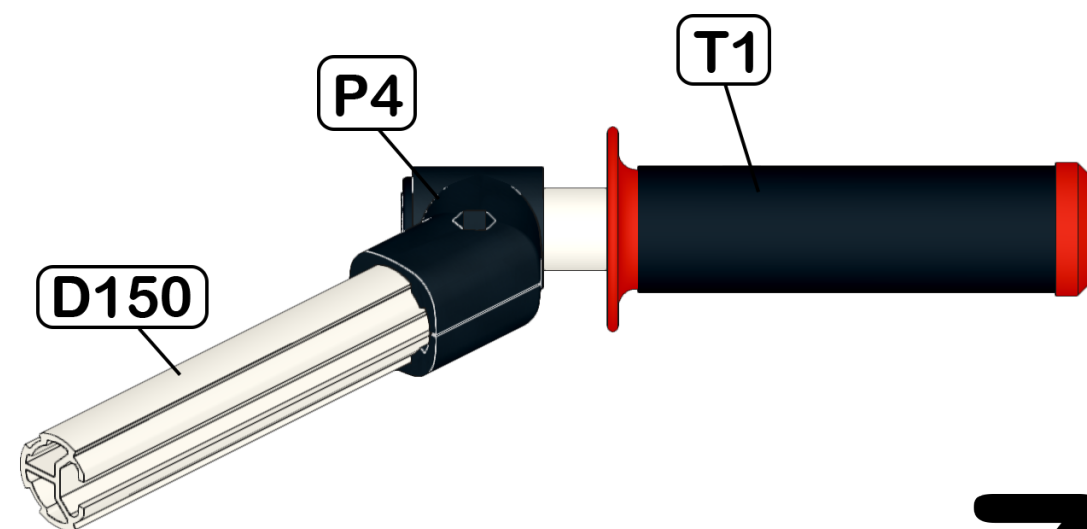

7

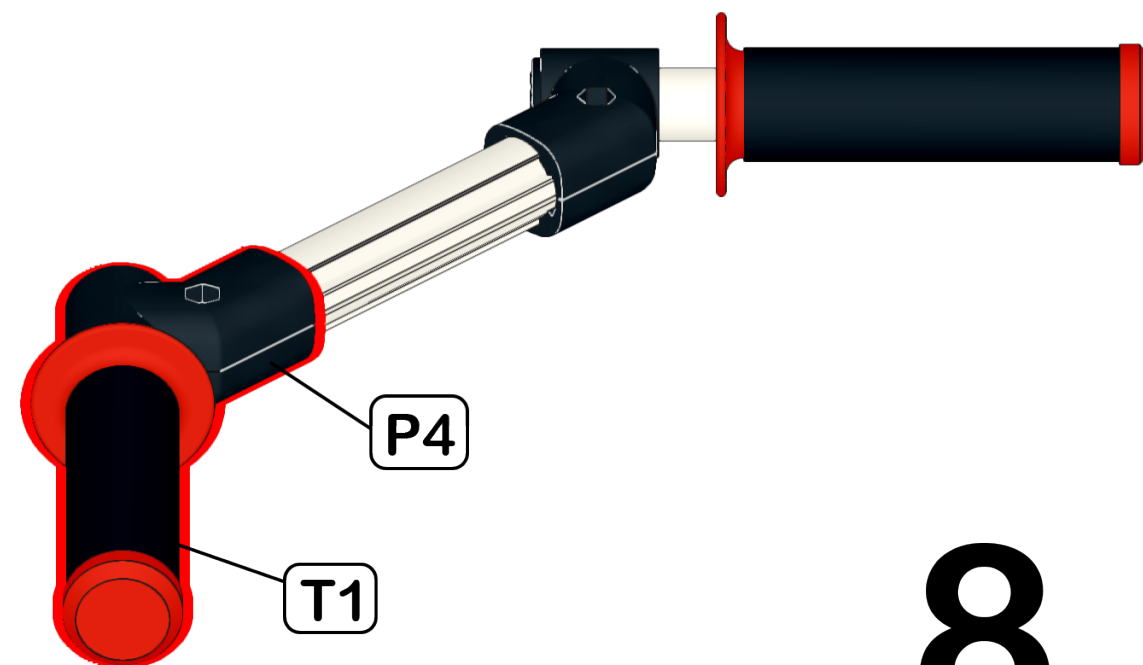

8

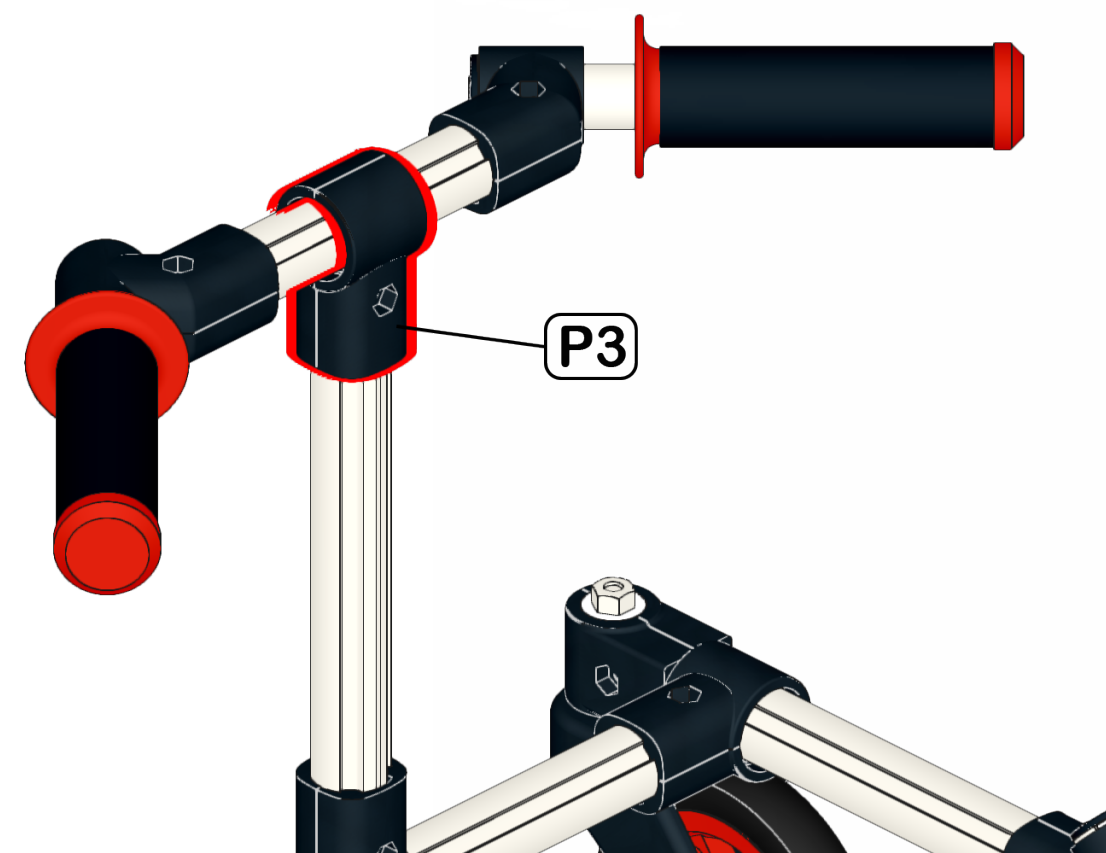

9

