

# Operating and installation instructions

## Ceramic cooktop



To avoid the risk of accidents or damage to the appliance, it is **essential** to read these instructions before it is installed and used for the first time.

# Contents

---

<b>Guide to the appliance</b> .....	4
Cooktop .....	4
Control panel .....	5
Cooking zones .....	6
<b>Warning and Safety instructions</b> .....	7
<b>Caring for the environment</b> .....	16
<b>Before using for the first time</b> .....	17
Cleaning for the first time .....	17
Before using for the first time .....	17
<b>How the cooking zones work</b> .....	18
<b>Use</b> .....	19
Operation .....	19
Switching on .....	20
Settings .....	21
Auto heat-up .....	22
Switching off and residual heat indicators .....	24
<b>Pots and pans</b> .....	25
<b>Tips on saving energy</b> .....	26
<b>Safety features</b> .....	27
Safety lock/System lock .....	27
Safety cut-out .....	29
Overheating protection .....	30
<b>Cleaning and care</b> .....	31
<b>Additional functions</b> .....	33
Reset .....	33
Programming .....	34
<b>Problem solving guide</b> .....	36

<b>To test the power setting</b> .....	40
<b>Optional accessories</b> .....	42
<b>Safety instructions for installation</b> .....	43
<b>Safety clearances</b> .....	44
<b>Notes on installation</b> .....	46
<b>Building-in dimensions</b> .....	47
<b>Installation</b> .....	48
<b>Electrical connection</b> .....	51
Wiring diagram .....	52
<b>After sales service, data plate, warranty</b> .....	53

# Guide to the appliance

---

## Cooktop

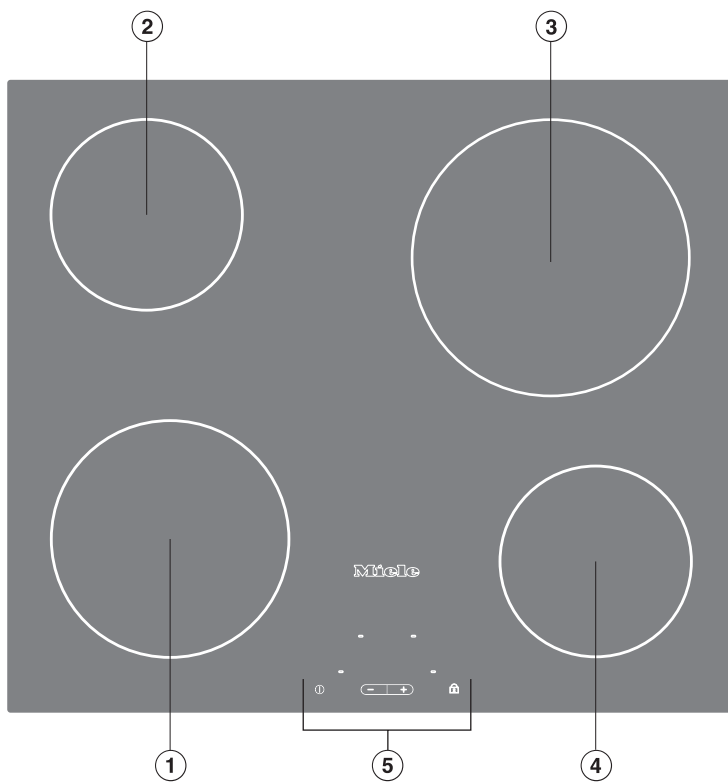

①②③④ Cooking zones

⑤ Control panel

## Control panel

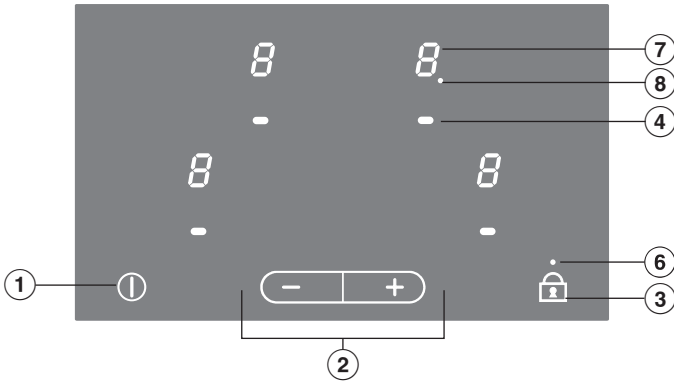

### Sensors

- ① For switching the cooktop on or off
- ② For setting the power settings
- ③ Safety lock
- ④ For selecting the cooking zones

### Check/Refill indicators

- ⑥ Safety lock

### Cooking zone display





- ⑦
  - 0* = Cooking zone ready for use
  - 1* to *9* = Power settings
  - ≡* = Residual heat
  - F* = Fault (see "Safety switch-off")
  - R* = Auto heat-up when the power setting range has been extended

- ⑧ Indicator lamp for Auto heat-up or extended power setting (see "Programming"), e.g. the rear right cooking zone

# Guide to the appliance

---

## Cooking zones

Cooking zone	KM 5600	
	Ø in cm	Rating in watts for 230 V
	18.0	1800
	14.5	1200
	21.0	2200
	14.5	1200
		Total: 6400

## Warning and Safety instructions

---

This appliance complies with all relevant safety requirements. Inappropriate use can, however, lead to personal injury and damage to property.

To avoid the risk of accidents and damage to the appliance, please read these instructions carefully before installation and before using it for the first time. They contain important notes on installation, safety, use and maintenance. Miele cannot be held liable for damage caused by non-compliance with these Warning and Safety instructions.

Keep these instructions in a safe place and ensure that new users are familiar with the content. Pass them on to any future owner.

# Warning and Safety instructions

---

## Correct application

- ▶ This cooktop is designed for domestic use and for use in similar environments by guests in hotel or motel rooms, bed & breakfasts and other typical living quarters. This does not include common/shared facilities or commercial facilities within hotels, motels or bed & breakfasts.
- ▶ The appliance is not suitable for outdoor use.
- ▶ This appliance must only be used to cook food and keep it warm. Any other use is not supported by the manufacturer and could be dangerous.
- ▶ This appliance is not intended for use by persons (including children) with reduced physical, sensory or mental capabilities, or lack of experience or knowledge, unless they have been given supervision or instruction concerning its use by a person responsible for their safety.
- ▶ Do not modify this appliance.



## Safety with children

- ▶ Small children must be kept away from the appliance unless they are constantly supervised.
- ▶ Older children may only use the appliance if they have been shown how to use it in a safe way and understand the hazards involved.
- ▶ Children must not be allowed to clean the appliance unsupervised.
- ▶ This appliance is not a toy! To prevent the risk of injury, do not allow children to play with the appliance or its controls.
- ▶ The appliance gets hot when in use and remains hot for a while after being switched off. Keep children well away from the appliance until it has cooled down and there is no danger of burning.
- ▶ Packaging, e.g. cling film, polystyrene and plastic wrappings, must be kept out of the reach of babies and children. Danger of suffocation. Dispose of or recycle all packaging safely as soon as possible.
- ▶ Danger of burning.  
Do not store anything which might arouse a child's interest in storage areas above or next to the appliance. Otherwise they could be tempted into climbing onto the appliance
- ▶ Danger of burning or scalding.  
Keep all pans out of reach of children. Turn pan handles inwards away from the edge of the cooktop.
- ▶ Activate the safety lock to ensure that children cannot switch on the appliance inadvertently. Use the safety lock when the cooktop is in use to prevent children from altering the settings selected.

# Warning and Safety instructions

---

## Technical safety

▶ Installation, maintenance and repair work may only be carried out by a suitably qualified and competent person in strict accordance with national and local safety regulations. Installation, maintenance and repairs by unqualified persons could be dangerous. Miele cannot be held liable for unauthorised work.

▶ A damaged appliance can be dangerous. Check the appliance for visible signs of damage. Do not use a damaged appliance.

▶ The electrical safety of this appliance can only be guaranteed if correctly earthed. It is most important that this basic safety requirement is observed and regularly tested, and where there is any doubt, the household wiring system should be inspected by a qualified electrician.

▶ To avoid the risk of damage to the appliance, make sure that the connection data (frequency and voltage) on the data plate corresponds to the household supply, before connecting the appliance to the mains supply. Consult a qualified electrician if in any doubt.

▶ Do not connect the appliance to the mains electricity supply by a multi-socket adapter or an extension lead. These do not guarantee the required safety of the appliance (e.g. danger of overheating).

▶ For safety reasons, this appliance may only be used after it has been built in.

▶ This cooktop must not be installed and operated in mobile installations (e.g. on a ship).

▶ Do not open the casing of the appliance. Tampering with electrical connections or components and mechanical parts is highly dangerous to the user and can cause operational faults.

## Warning and Safety instructions

---

- ▶ While the appliance is under warranty, repairs should only be undertaken by a service technician authorised by Miele. Otherwise the warranty will be invalidated.
- ▶ The manufacturer can only guarantee the safety of the appliance when original Miele replacement parts are used. Faulty components must only be replaced by genuine Miele original spare parts.
- ▶ The cooktop is not intended for use with an external timer switch or a remote control system.
- ▶ The cooktop must be connected to the electrical supply by a qualified electrician. If the electrical connection cable is faulty, it must be replaced with a special connection cable installed by a qualified electrician. See "Electrical connection".
- ▶ The appliance must be disconnected from the mains electricity supply during installation, maintenance and repair work. Ensure that power is not supplied to the appliance until after it has been installed or until any maintenance or repair work has been carried out.  
It is only completely isolated from the electricity supply when:
  - the mains fuse is disconnected,
  - the screw-out fuse is removed  
(in countries where this is applicable),
  - it is switched off at the wall socket and the plug is withdrawn from the socket, or it is switched off at the isolator.
- ▶ If the cooktop is fitted with a communication module, in addition to disconnecting the cooktop, this module must also be disconnected from the mains electricity during installation and maintenance of the cooktop as well as while any repair work is being carried out.

## Warning and Safety instructions

---

▶ Danger of electric shock.

Do not use the cooktop if it is faulty, or if the ceramic surface is cracked, chipped or damaged in any way. Switch it off immediately, and disconnect it from the mains electricity supply.

▶ In areas which may be subject to infestation by cockroaches or other vermin, pay particular attention to keeping the appliance and its surroundings clean at all times. Any damage caused by cockroaches or other vermin will not be covered by the warranty.

# Warning and Safety instructions

---

## Correct use

- ▶ Oil and fat can overheat and catch fire. Do not leave the appliance unattended when cooking with oil or fat. If oil or fat does catch fire, do not attempt to put out the flames with water. Disconnect the appliance from the mains and use a suitable fire blanket, saucepan lid, damp towel or similar to smother the flames.
- ▶ Do not flambé under a rangehood. The flames could set the rangehood on fire.
- ▶ Spray canisters, aerosols and other inflammable substances can ignite when heated. Therefore do not store such items or substances in a drawer under the cooktop. Cutlery inserts must be heat-resistant.
- ▶ Do not heat an empty pan.
- ▶ Do not heat up unopened tins of food on the cooktop, as pressure will build up in the tin, causing it to explode.
- ▶ Do not cover the cooktop, e.g. with a cooktop cover, a cloth or protective foil. The material could catch fire, shatter or melt if the appliance is switched on by mistake or if residual heat is still present.
- ▶ When using an electrical appliance, e.g. a hand-held food blender, near the appliance, ensure that the cable of the electrical appliance cannot come into contact with the hot appliance. The insulation on the cable could become damaged.
- ▶ Do not use plastic or aluminium foil containers. These melt at high temperatures and could catch fire.
- ▶ If the appliance is installed behind a kitchen furniture door, it may only be used with the furniture door open. Do not close the door whilst the cooktop is in use or whilst there is any residual heat present.

## Warning and Safety instructions

---

▶ The appliance gets hot when in use and remains hot for a while after being switched off. There is a danger of burning until the residual heat indicators go out.

▶ You could burn yourself on the hot cooktop. Protect your hands with heat-resistant pot holders or gloves when handling hot pots and pans. Do not let them get wet or damp, as this causes heat to transfer through the material more quickly with the risk of scalding or burning yourself.

▶ When the appliance is switched on either deliberately or by mistake, or when there is residual heat present, there is the risk of any metal items left on the cooktop heating up, with the danger of burning.

Depending on the material, other items left on the cooktop could also melt or catch fire.

Damp pan lids might adhere to the ceramic surface and be difficult to dislodge.

Do not use the appliance as a resting place.

Switch the cooking zones off after use.

▶ Do not allow solid or liquid sugar, or pieces of plastic or aluminium foil to get onto the cooking zones when they are hot, as they can damage the ceramic surface when it cools down. If this should occur, switch off the appliance and scrape off all the sugar, plastic or aluminium residues from the cooktop whilst still hot using a shielded scraper blade. Wear oven gloves.

Allow the cooking zones to cool down and then clean them with a suitable ceramic cooktop cleaning agent.

▶ Pans which boil dry can cause damage to the ceramic glass. Do not leave the appliance unattended whilst it is being used.

▶ Do not use pots or pans on the cooktop with bases with pronounced edges or ridges. These could scratch or scour the ceramic glass surface permanently. Only use pots and pans with smooth bases.

## Warning and Safety instructions

---

- ▶ Lift pans into position on the cooktop. Sliding them into place will cause scuffs and scratches.
- ▶ Grains of salt, sugar and sand (e.g. from cleaning vegetables) can cause scratches if they get under pan bases. Make sure that the ceramic surface is clean before placing pans on it.
- ▶ Even a light object could cause damage in certain circumstances. Do not drop anything on the ceramic surface.
- ▶ Do not place hot objects on the control field as this could cause damage to the electronics underneath. Do not place hot pans on the touch display.
- ▶ Do not use the appliance to heat up the room. Due to the high temperatures radiated, objects near the appliance could catch fire. The life of the appliance could also be reduced.
- ▶ The following factors can cause the area around the control panel and the frame or edges of the cooktop to become hot: The length of time the cooktop has been used for, using it on high settings, using large pans, and the number of zones in use at any one time.
- ▶ Pots and pans made of aluminium or with an aluminium base can leave a metallic sheen on the cooktop. This can be removed with the Original Miele ceramic and stainless steel cooktop cleaner (see "Cleaning and care").
- ▶ To prevent the risk of spillages etc. burning on, remove any soiling as quickly as possible and ensure that pan bases are clean, dry and free of grease.

### Cleaning and care

- ▶ Do not use a steam cleaning appliance to clean this appliance. The steam could reach electrical components and cause a short circuit.

# Caring for the environment

---

## Disposal of the packing material

The transport and protective packing has been selected from materials which are environmentally friendly for disposal and should be recycled.

Recycling the packaging reduces the use of raw materials in the manufacturing process and also reduces the amount of waste in landfill sites. Ensure that any plastic wrappings, bags, etc. are disposed of safely and kept out of the reach of babies and young children. Danger of suffocation.

## Disposing of your old appliance

Electrical and electronic appliances often contain materials which, if handled or disposed of incorrectly, could be potentially hazardous to human health and to the environment. They are, however, essential for the correct functioning of your appliance. If handled or disposed of incorrectly they could be potentially hazardous to human health and to the environment. Please do not dispose of your appliance with household waste.

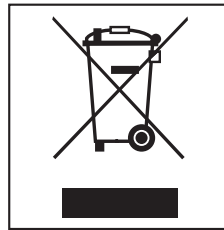

Please dispose of it at your local community waste collection / recycling centre or contact your Chartered Agent for advice.

Ensure that it presents no danger to children while being stored for disposal.



## Before using for the first time

---

Please stick the extra data plate for the appliance supplied with this documentation in the space provided in the "After sales service" section of this booklet.

### Cleaning for the first time

- Remove any protective wrapping and adhesive labels.
- Before using for the first time, clean the appliance with a damp cloth only and then wipe dry.

### Before using for the first time

On cooktops with bevelled glass edges, a small gap may be visible between the cooktop and the worktop during the first few days after installation. This gap will reduce with time as the appliance is used and will not affect the electrical safety of your appliance.

The metal components have a protective coating which may give off a slight smell when heated up for the first time.

The smell and any vapours given off do not indicate a faulty connection or appliance, and neither are they hazardous to health.

# How the cooking zones work

---

Single circle cooking zones have one heating element, whilst double circle cooking zones and extended zones have two. Depending on the model, the heating elements may be separated by an insulating ring.

Each cooking zone has overheating protection (a temperature limiter), which stops the ceramic surface from becoming too hot (see "Overheating protection").

When a power setting is selected, the heat switches on and the element can be seen through the ceramic surface.

The temperature of the cooking zones depends on the power setting selected, and is electronically regulated. This controls the "timing" of a cooking zone, switching the element on and off.

## Single circle zone

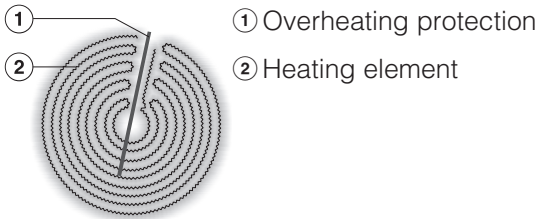

## Double circle zone

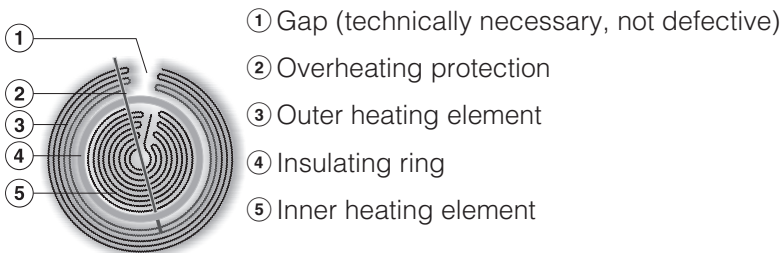

---

## Operation

This ceramic cooktop is equipped with electronic sensor switches which react to finger contact.

To operate a cooking zone, touch the relevant sensor. Each time you touch a sensor, an audible tone sounds.

The cooking zones have to be "active" when you want to set or adjust a power setting or the duration.

To activate the cooking zone, touch the appropriate sensor of the cooking zone. The sensor will start to flash on and off after you touched it. While the sensor is flashing, set or adjust the power setting or the duration.

Take care to keep the control area clean. Do not place anything on the control area. The sensor switches may fail to react or they could mistake the article or any dirt for a fingertip contact, thereby activating a function or even causing the cooktop to switch off automatically (see Safety switch-off.)

Never place hot pans on the sensor switches. The electronic unit underneath could get damaged.

# Use

---

## Switching on

The cooktop must be switched on before any of the zones can be used.

Do not leave the appliance unattended whilst it is being used.

### To switch the cooktop on

- Touch the "ⓘ" sensor.

ⓘ appears in each of the cooking zone displays. If no further entry is made, the cooktop will switch itself off after a few seconds for safety reasons.

### Switch on the cooktop, select the power setting

- Briefly touch the sensor of the required cooking zone.

A ⓘ will flash in the display.



- Whilst the ⓘ is flashing, select a power setting by touching the - or + sensor.

To select cooking **with** Auto heat-up, press the - sensor first (see "Auto heat-up"). To select cooking **without** Auto heat-up, press the + sensor first.

The power setting selected flashes in the display for a few seconds to start with and then lights up constantly.

### Change the power setting

- Briefly touch the sensor of the desired cooking zone.

The power setting flashes on and off.



- Touch the + or - sensors to set the required power setting.

## Settings

The appliance is programmed with 9 power settings at the factory. If you wish to fine-tune a setting, you can extend the power setting range (see "Programming"). The intermediate setting will be represented by an illuminated dot next to the number.

Cooking process	Settings*	
	Standard factory settings (9 settings)	Extended settings (17 settings)
Melting butter, chocolate etc. Dissolving gelatine Preparing yoghurt	1 - 2	1 - 2.
Thickening sauces containing egg yolk and butter Warming small quantities of food/liquid Keeping warm food which sticks easily Cooking rice	1 - 3	1 - 3.
Warming liquid and semi-solid foods Thickening sauces, e.g. Hollandaise Making porridge Preparing omelettes, lightly fried eggs Steaming fruit	2 - 4	2 - 4.
Defrosting deep frozen food Steaming vegetables, fish Cooking dumplings, potatoes, pulses Cooking broths, pulse soups	3 - 5	3 - 5.
Bringing to the boil and continued cooking of large quantities of food	5	5.
Gentle braising (without overheating the fat) of meat, fish, vegetables, fried eggs etc.	6 - 7	6 - 7.
Frying pancakes etc.	7 - 8	7 - 8.
Boiling large quantities of water Bringing to the boil	8 - 9	8. - 9

\* These settings, which envisage approx. 4 servings, should only be taken as a guide. With deep pans, large quantities or when cooking without the lid, a higher setting is required. For smaller quantities, select a lower setting.

# Use

---

## Auto heat-up

When Auto heat-up has been activated, the cooking zone switches on automatically at the highest setting and then switches to the continued cooking setting which you have previously selected. The heat-up time depends on which continued cooking setting has been chosen (see chart).

As the higher continued cooking settings are generally used for frying food, only a relatively short heat-up time is needed to heat up the pan initially.

### To activate Auto heat-up

- Briefly touch the sensor of the required cooking zone.

The display of the cooking zone will flash.

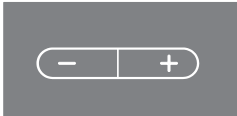

- Select the required continued cooking setting, e. g. **5**, by touching the sensor switch -.

During the heat-up time an indicator lamp to the right of the continued cooking setting will light up, and go out at the end of it.

In the **extended** range of settings (see "Programming"), **R** flashes alternately with the continued cooking setting until the heat-up time has finished.

Changing the continued cooking setting deactivates Auto heat-up.

### Deactivate Auto heat-up

You can deactivate the Auto heat-up before the end of the heat-up time.

- Briefly touch the sensor of the required cooking zone.

The power setting flashes on and off.

- Switch on the cooking zone at the highest setting.

<b>Continued cooking setting*</b>	<b>Heat-up time in minutes and seconds (approx.)</b>
1	1 : 20
1.	2 : 00
2	2 : 45
2.	3 : 25
3	4 : 05
3.	4 : 45
4	5 : 30
4.	6 : 10
5	6 : 50
5.	7 : 10
6	1 : 20
6.	2 : 00
7	2 : 45
7.	2 : 45
8	2 : 45
8.	2 : 45
9	-

\* The continued cooking settings with a dot after the number are only available if the power setting range has been extended (see "Programming").

# Use

---

## Switching off and residual heat indicators

### To switch off a cooking zone

- Touch the sensor of the required cooking zone twice.

A  flashes in the cooking zone display for a few seconds. If the cooking zone is still hot, the residual heat indicator will then appear in the display.

### To switch off the cooktop

- Touch the "Ⓛ" sensor.

This switches off all cooking zones. The residual heat indicator will appear in the display of any cooking zone which is still hot.

### Residual heat indicator

The lines of the residual heat indicator go out one after another as the cooking zones cool down. The last horizontal line only goes out when the cooking zone is safe to touch.

Do not touch or place any heat-sensitive objects on the cooking zones while the residual heat indicators are on.  
Danger of fire!

After a circuit break-off, all residual heat indicators will flash.



- The best pots and pans are those **with a thick base** which is very slightly concave when cold. When heated, the base flattens to rest evenly on the cooktop, optimising the conduction of the heat.

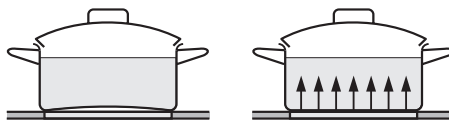

Cold

Hot

- Pots made of glass, ceramic or stoneware **are less suitable**, as they do not conduct the heat so well.
- Pots and pans made of synthetic material or aluminium **are not suitable**. These melt at high temperatures.
- Pots and pans made of copper or with a copper base **are not suitable** for use on this cooktop.
- Pots and pans made of aluminium or with an aluminium base can leave a metallic sheen on the cooktop. This can be removed with the Original Miele ceramic and stainless steel cooktop cleaner (see "Cleaning and care").
- Do not use pots and pans on the ceramic cooktop with bases with pronounced edges or ridges, e.g. cast iron pans. These could scratch or scour the cooktop surface permanently.
- Lift pans into position on the cooktop. Sliding them into place will cause scuffs and scratches.
- Please note that the maximum diameter quoted by manufacturers often refers to the diameter of the top rim of the pot or pan. The diameter of the base (generally smaller) is more important.

# Tips on saving energy

---

- Check that the diameter of the pan base is wide enough for the cooking zone so that heat is not lost unnecessarily.



Too small

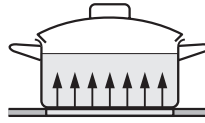

Suitable

- Use a lid whenever possible to minimise heat loss.

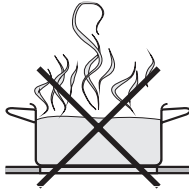

Uncovered



Covered

- Select a smaller pan when cooking small quantities. A small pan on a small cooking zone uses less energy than a large, partially filled pan on a large cooking zone.
- Cook with as little water as possible.
- Reduce the power setting once the water has come to the boil or the oil is hot enough to fry in.
- When cooking for a long time, switch the cooking zone off about 5 to 10 minutes before the end of the cooking time. In this way, use is made of the residual heat.
- Cooking times can be significantly reduced with a pressure cooker.

## Safety lock/System lock

Keep children away from the cooktop for their own safety. Your appliance is equipped with a safety lock to prevent the cooktop and the cooking zones being switched on or any settings being altered.

The **Safety lock** is activated when the cooktop is switched on. If the safety lock is activated:

- The settings for the cooking zones cannot be changed.
- The cooking zones and cooktop can be switched off, but once switched off cannot be switched on again.

The **System lock** is activated when the cooktop is switched off. If the system lock is activated, the cooktop cannot be switched on.

The cooktop is programmed in such a way that the system lock has to be operated manually. The settings can be changed so that the system lock is activated automatically five minutes after the cooktop has been switched off (see "Programming").

If any of the other sensors is touched while the safety lock is active:

- **L** appears in the front left and **L** in the front right cooking zone display for approx. 3 seconds.
- The confirmation tone sounds a bit longer than normal (cooktops with ring extension).
- The control light lights up (cooktops without ring extension).

The safety lock and the system lock are deactivated in case of a power cut.

# Safety features

---

## To activate the safety lock

- Touch the sensor switch  until the appropriate control light lights up and an audible tone sounds.

The indicator lamp will go out after a short while.

## To deactivate the safety lock

- Touch the  sensor until the indicator lamp goes out.

## Safety cut-out

### Safety switch-off with an over-long cooking time

If one of the cooking zones is heated for an unusually long period of time (see chart), and the power settings are not altered, the cooktop will switch itself off automatically and the corresponding residual heat indicator will appear.

To use the cooking zone again, switch it back on in the usual way.

Power setting*	Maximum operating time in hours
1 / 1.	10
2 / 2.	5
3 / 3.	5
4 / 4.	4
5 / 5.	3
6 / 6.	2
7 / 7.	2
8 / 8.	2
9	1

\* The continued cooking settings with a dot after the number are only available if the power setting has been increased (see "Programming").

### Safety switch-off if the sensors are covered

Your cooktop will switch off automatically if one or several of the sensors remain covered for longer than 13 seconds, for example, by finger contact, food boiling over or by an object such as an oven glove or tea towel.

*F* will flash in all displays. An audible tone will sound every 30 seconds (for a maximum of ten minutes).

■ Clean the control area or remove the obstruction.

This will turn off the tone and the *F* will go out. You can operate the appliance again.

# Safety features

---

## Overheating protection

### Cooking zones

Each zone is equipped with overheating protection (internal temperature limiter). This switches off the heating element automatically before the ceramic surface overheats.

You can tell that the overheating protection has activated because the heating switches on and off even when the highest setting is selected.

Once the ceramic surface has cooled down to a safe level, the heating will automatically switch back on again.

Overheating can be caused by:

- a cooking zone being switched on without a pan on it
- heating up an empty pan
- the base of a pan not sitting evenly on the cooking zone
- the pan is not conducting heat properly.

### Control panel

The electronics of the control panel are equipped with overheating protection. This switches off the heating element automatically before the ceramic surface overheats.

The fault message *FE37* will be displayed.

Once the electronics have cooled off sufficiently, the fault message will disappear and you will be able to operate the cooktop normally.

The overheating protection can be switched on, if more than one cooking zone is operated on a high setting for a longer period of time.

 Do not use a steam cleaning appliance to clean this appliance. The steam could reach the electrical components and cause a short circuit.

The appliance should be cleaned regularly, preferably after each use. Allow it to cool down to room temperature before cleaning.

To avoid water marks and limescale deposits, use a soft cloth to dry surfaces that have been cleaned with water.

**To avoid damaging the outer surfaces of your appliance, do not use:**

- Washing-up liquid,
- cleaning agents containing soda, alkalines, ammonia, acids or chlorides,
- cleaning agents containing descaling agents,
- stain or rust removers,
- abrasive cleaning agents, e.g. powder cleaners and cream cleaners,
- solvent-based cleaning agents,
- dishwasher cleaner,
- grill and oven cleaners,
- glass cleaning agents,
- hard, abrasive brushes or sponges, e.g. pot scourers, brushes or sponges which have been previously used with abrasive cleaning agents,
- dirt erasers,
- sharp, pointed objects which could damage the seal between the ceramic surface and the surrounding frame, and between the frame and the worktop.

## Cleaning and care

---

Do not use washing-up liquid to clean the appliance. Using washing-up liquid will not remove all soiling and an invisible film will be left behind which will result in a permanent discolouration of the ceramic surface.  
Clean the cooktop regularly with a special ceramic cleaning agent.

Wipe all coarse soiling off using a damp cloth. Stubborn soiling may need to be removed with a shielded scraper blade.

Then clean the cooktop with the Original Miele ceramic and stainless steel cooktop cleaner (see "Optional accessories"), applied with kitchen paper or a clean cloth. Do not apply cleaner whilst the cooktop is still hot, as this could result in marking. Please follow the manufacturer's instructions.

Finally, wipe the cooktop with a damp cloth, then polish with a soft, dry cloth. Ensure that all cleaner residues are removed. Residues can burn onto the appliance the next time it is used, and cause damage to the ceramic surface.

**Spots** caused by limescale, water and aluminium residues (spots with a metallic appearance) can be removed using the Original Miele ceramic and stainless steel cooktop cleaner.

Should any **sugar, plastic or aluminium foil** spill or fall onto a hot cooking zone while it is in use, first switch off the appliance. Then carefully scrape off all the sugar, plastic or aluminium residues from the cooking zone **whilst it is still hot**, using a shielded scraper blade. Take care not to burn yourself.

Allow the appliance to cool down, and then clean as described above.



### Reset

This appliance is supplied with a reset function. This function allows you to reset the settings of the programming to the factory default settings.

### How to reset

- Switch the cooktop on.
- Touch the front left and the front right sensors of the cooking zones simultaneously for 10 seconds.

# Additional functions

---

## Programming

You can change the default settings of the programme options (see chart). Several settings can be altered in succession.

After calling up programming, **P** (programme), **5** (status) and numbers appear in the cooking zone display. This shows the current setting.

### Calling up programming

- While the cooktop is switched off, touch the sensor switches  and  **at the same time** until the appropriate control light flashes.

### Set a programme, set a status

- Touch the **front left** cooktop sensor.
- Touch the **+** or **-** sensors to set the required **programme**.
- Touch the **front right** cooktop sensor.
- Touch the **+** or **-** sensors to set the required **status** (see chart).

### How to store the settings

- Touch the  sensor until the displays go out.

### How to not store the settings

- Touch the  sensor until the displays go out.

## Additional functions

Programme*	Status**	Setting
<b>P 0</b> Demonstration mode and factory default settings	S 0	Demonstration mode on (the front left <i>d</i> and front right <i>E</i> cooking zone displays come on after switching the cooktop on).
	<b>S 1</b>	Demonstration mode off
	S 9	Factory default settings reinstated
<b>P 2</b> Power setting range	<b>S 0</b>	9 power settings (1, 2, 3 ... to 9)
	S 1	17 power settings (1, 1., 2, 2., 3 ... to 9) If the Auto heat-up setting is selected, an <i>H</i> will flash alternately with the continued cooking setting in the display.
<b>P 4</b> Keypad tone when a sensor is touched	S 0	Off
	S 1	Quiet
	<b>S 2</b>	Medium
	S 3	Loud
<b>P 7</b> System lock	<b>S 0</b>	Activating the system lock manually only
	S 1	Activating the system lock automatically and manually
<b>P 6.</b> Sensor switch reaction speed	S 0	Slow
	<b>S 1</b>	Normal
	S 2	Rapid

\* Programmes/Status not shown here have no allocation.

\*\* The factory default settings are shown in bold.

# Problem solving guide

With the aid of the following guide, minor problems can be easily corrected without contacting Miele.

This will save you time and money because you won't need to book a Service technician.

The following information may help you to find the reason for a fault, and to correct it. Please note:

 Installation work and repairs to electrical appliances must only be carried out by a suitably qualified and competent person in strict accordance with current local and national safety regulations. Repairs and other work by unqualified persons could be dangerous. The manufacturer cannot be held liable for unauthorised work. Ensure that current is not supplied to the appliance until after maintenance or repair work has been carried out.

Problem	Possible cause	Remedy
<b>The cooktop or cooking zones cannot be switched on</b>	The system lock has been activated.	You need to deactivate the system lock (see "Safety lock").
	The fuse is defective or has tripped.	Reset or replace the fuse.
	There may be a technical fault.	Disconnect the appliance from the mains connection for approx. 1 minute: – switch off at the wall socket, or switch off at the isolator,  or – disconnect the mains fuse.  Reset the trip switch in the mains fuse box, and switch the appliance back on. If it still will not switch on, contact a qualified electrician or Miele.

## Problem solving guide

Problem	Possible cause	Remedy
<p><b>After switching the cooktop on, <i>d</i> appears in the front left and <i>E</i> appears in the front right cooking zone display. The cooking zones won't heat up.</b></p>	<p>The appliance is in demo-mode.</p>	<p>You need to deactivate the demo-mode (see "Programming").</p>
<p><b>The appliance switches off during operation.</b></p>	<p>A cooking zone might have been operated for too long.</p>	<p>This doesn't indicate a fault. You can continue operation (see "Safety switch-off").</p>
<p><b>The cooking zone heating switches on and off.</b></p>	<p>Power setting 1 to 8: This is not a fault.</p>	<p>This doesn't indicate a fault. The "timing" of the element is normal. It is caused by the electronic temperature control (see "How the cooking zones work").</p>
	<p>Power setting 9: fault The overheating protection mechanism has switched.</p>	<p>Once the ceramic surface has cooled down to a safe level, the heating will automatically switch back on again.</p>

## Problem solving guide

Problem	Possible cause	Remedy
<b>The appliance switches off during operation and F appears in all cooking zone displays and an audible tone sounds.</b>	One or several of the sensors are covered, for example, by finger contact, food boiling over or by an object such as an oven glove or tea towel.	Clean the control area or remove the obstruction (see "Safety switch-off").
<b>The food in the pan hardly heats up or does not heat up at all when the Auto heat-up function is switched on.</b>	There is too much food in the pan.	Start cooking at the highest setting, then turn the heat down manually.
	The pan is not conducting heat properly.	
<b>One or several residual heat indicators flash.</b>	There was an interruption to the power supply during operation, and the cooktop has switched itself off.	This doesn't indicate a fault. You can continue operation. Check the food's level of doneness and whether it was affected by the power cut before continuing operation on the cooking zone.
	The residual heat indicators lit up when you called up the programming.	This doesn't indicate a fault. The indicator lights will continue flashing until the maximum residual heat has elapsed or the cooking zone is switched on.
<b>It is taking too long for the contents of the pan to come to the boil.</b>		You can test the power setting of the cooking zone (see "To test the power setting").

## Problem solving guide

Problem	Possible cause	Remedy
<b>The sensor switches show increased sensitivity or fail to react.</b>	The sensitivity level of the sensor switches has changed.	Make sure that there is no direct light (from the sun or from an artificial source) falling onto the cooktop. The area surrounding the cooktop, however, must not be too dark.
<b>F lights up in the back left display, E lights up in the back right display and the front displays show numbers.</b>		Make sure the cooktop or the sensor switches aren't covered. Take any pans off the cooktop and wipe away any food deposits.
<b>left      right</b>		Interrupt the power supply to the cooktop for approx. 1 minute.
<b>9          0</b>	There has been an alignment fault after resetting the appliance or after a power cut. If the display doesn't switch off after 5 minutes, proceed as described on the right.	If this does not solve the problem, please call Miele.
<b>9          1</b>		
<b>9          2</b>		
<b>9          3</b>		
<b>3          7</b>	The overheating protection mechanism has switched.	This doesn't indicate a fault. You can continue operation as soon as the fault message has disappeared (see "Overheating protection").
<b>All other faults</b>	There has been a fault in the electronics.	Interrupt the power supply to the cooktop for approx. 1 minute. If the problem persists after reconnecting the appliance to the power supply, please contact Miele.

## To test the power setting

---

You can test the power setting of a cooking zone by measuring how long it takes to bring a specific amount of water to the boil.

The pan (and lid) must be stainless steel or enamel. The diameter of the pan must match the cooking zone, and be flat-bottomed or slightly concave.

- Take a note of the diameter and wattage of the cooking zone to be tested (see "Cooking zones").
- Fill the pan with the quantity of water given in the table. The temperature of the water should be approx. 20 °C.
- Place the pan with its lid on the cooking zone.
- Switch on the cooking zone at the highest setting.
- Note the time it takes for the water to boil.

The power setting for the cooking zone is fine if the water boils within the time given in the table.

The time can vary if:

- there are fluctuations in the mains electricity supply,
- very cold water is used,
- an unsuitable pan is used,
- the pan is not covered.



## To test the power setting

<b>Cooking zone Ø in cm</b>	<b>Rating in watts for 230 V</b>	<b>Quantity of water in litres</b>	<b>Duration* in minutes</b>
10.0	600	0.5	11.0
12.0	700 / 750	1.0	13.0
12.0	1200**	1.0	11.0
14.5	1000 / 1100	1.0	9.0
14.5	1200	1.0	8.5
14.5	1500**	1.0	7.0
17.0	1500	1.5	9.5
18.0	1700 / 1800	1.5	9.0
21.0	2000	2.0	10.5
21.0	2200 / 2300	2.0	9.5
21.0	2900**	2.0	8.0
23.0	2500	2.0	9.0
23.0	3200**	2.0	7.5
27.0	2700	3.0	13.0
27.0	3200	3.0	12.0
27.0	3400**	3.0	11,5

\* Max. duration under unfavourable conditions

\*\* ExtraSpeed cooking zone

## Optional accessories

---

Miele offers a comprehensive range of useful accessories as well as cleaning and conditioning products for your Miele appliances.

These can be ordered online at:



or from Miele (see back of manual for contact details).

### Cleaning products

#### **Original Miele ceramic and stainless steel cooktop cleaner** 250 ml



Removes heavy soiling, limescale deposits and aluminium residues.

#### **Original Miele all purpose microfibre cloth**

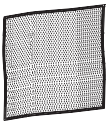

Removes finger marks and light soiling.

## Safety instructions for installation

---

All electrical work should be undertaken by a suitably qualified and competent person in strict accordance with current national and local safety regulations.

To avoid damaging the surface, it must only be installed after the wall units and the rangehood have been fitted.

- ▶ The veneer or laminate coatings of worktops (or adjacent kitchen units) must be treated with 100 °C heat-resistant adhesive which will not dissolve or distort. Any backmoulds must be of heat-resistant material.
- ▶ This cooktop must not be installed and operated in mobile installations (e.g. on a ship).
- ▶ The cooktop may not be built in over a fridge, fridge-freezer, freezer, dishwasher, washing machine or tumble dryer.

▶ After installing the cooktop, ensure that the connection cable cannot come into contact with the underside of the appliance. Make sure that there is no mechanical obstruction, such as a drawer, which could damage it.

▶ Observe carefully the safety distances given on the following pages.

All dimensions in this instruction booklet are given in mm.

# Safety clearances

---

## Safety distance to the undershelf

It is not necessary to install an undershelf underneath the cooktop.

If you do, however, install an undershelf, you have to ensure a safety distance between the upper edge of the worktop and the upper edge of the undershelf of at least 110 mm.

Make sure an air gap of at least 10 mm is set between the back edge of the undershelf and the back wall of the cupboard for the connection cable.

If the cooktop has an external mains connection box, the gap has to be at least 30 mm.

## Safety distance above the appliance

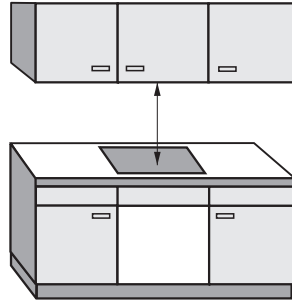

A minimum safety distance must be maintained between the appliance and the rangehood above it. See the rangehood manufacturer's operating and installation instructions for details. If the manufacturer's instructions are not available for the rangehood, a minimum safety distance of at least 760 mm must be maintained.

For any flammable objects, e.g. utensil rails, wall units etc., a minimum distance of at least 760 mm must be maintained between them and the appliance below.

When two or more appliances are installed together below a rangehood, e.g. a gas wok and a ceramic cooktop, which have different safety distances given in the installation instructions, you should select the greater distance of the two.

## Safety distances to the sides and back of the cooktop

Ideally the cooktop should be installed with plenty of space on either side. There may be a wall at the rear or a tall unit or wall on one side (right **or** left). On the other side, however, no unit or divider should stand higher than the cooktop (see illustrations).

Before installing the appliance, check that the below clearance requirements are met.

- ① The horizontal distance from the **back edge** of the cooktop to a vertical surface shall be 50 mm minimum.
- ② The horizontal distance from the **right edge** of the cooktop to a vertical surface shall be 50 mm minimum.
- ③ The horizontal distance from the **left edge** of the cooktop to a vertical surface shall be 50 mm minimum.

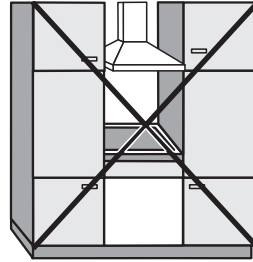

Not allowed

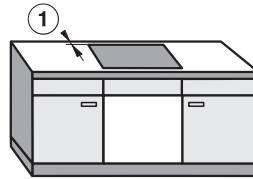
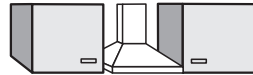

Recommended

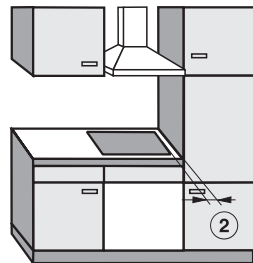

Not recommended

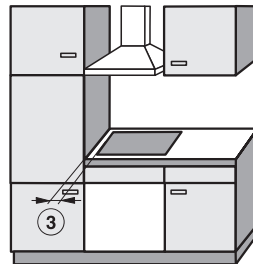

Not recommended

## Notes on installation

### Cooktops with frames and bevelled edges

#### Seal between the cooktop and the worktop

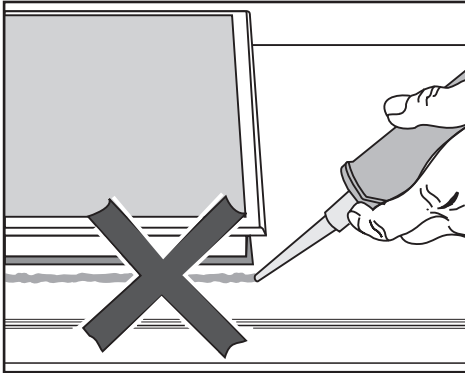

The sealing strip under the edge of the top part of the appliance provides a sufficient seal for the worktop.

Do not use any additional sealant (e.g. silicone) between the appliance and the worktop. This could cause difficulties if the appliance ever needs to be taken out for servicing and possibly result in damage to the cooktop or the worktop.

### Tiled worktop

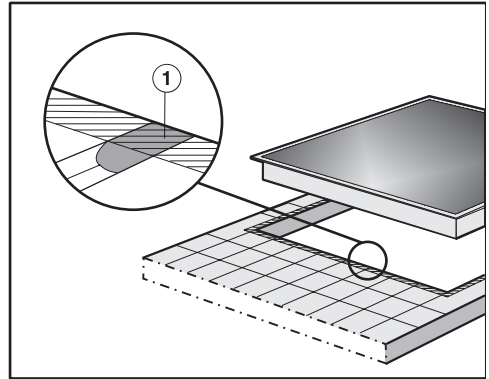

Grout lines ① and the hatched area underneath the cooktop frame must be smooth and even. If they are not, the cooktop will not sit flush with the worktop and the sealing strip underneath the cooktop will not provide a good seal between the cooktop and the worktop.

Tiled worktops must be a minimum of 5 mm thick to ensure the surface temperatures of the combustible surfaces underneath the tiles do not exceed 50 K above ambient.

# Building-in dimensions

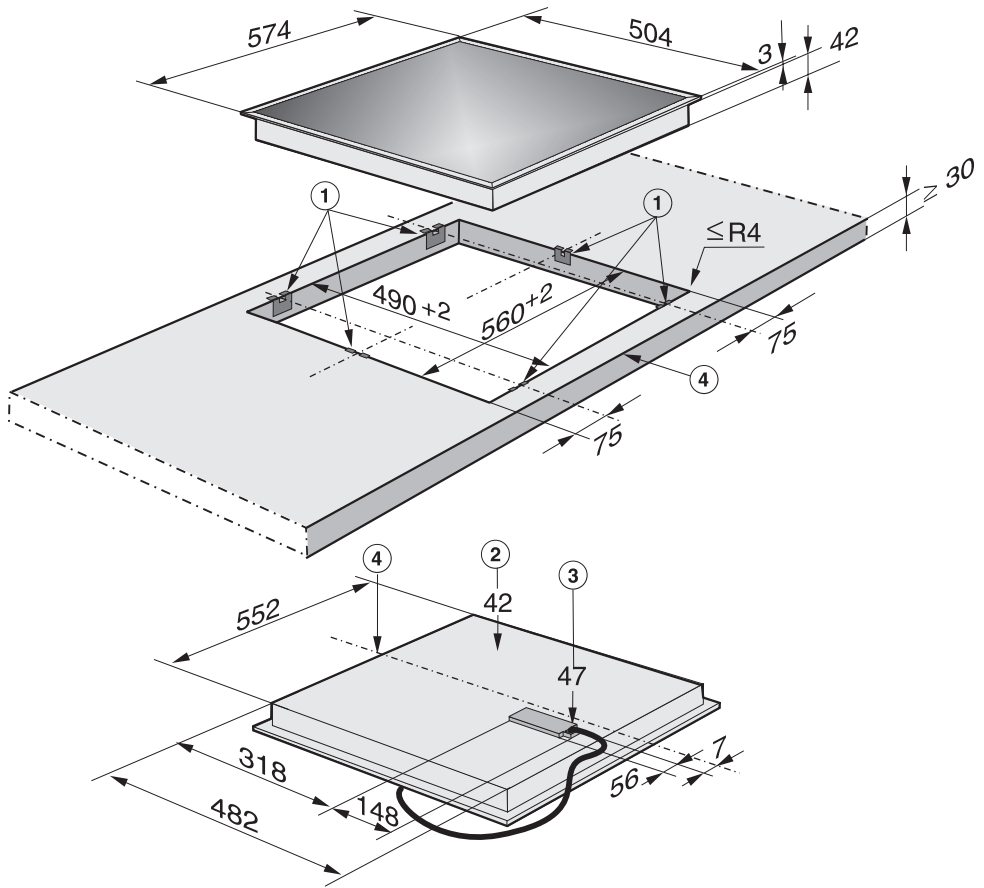

- ① Spring clamps
- ② Building-in height
- ③ Mains connection box with mains connection cable, L = 1,440 mm
- ④ Front

# Installation

Attach the spring clamps and the support brackets (only for cooktops with bevelled edges) as applicable.

Cooktops with bevelled edges:  
These cooktops have a sealing strip underneath them to keep the cooktop securely in position. Any gap between the frame and worktop will reduce with time.

- Make the worktop cut-out for one or more appliances as applicable. Remember to maintain a **minimum safety distance** (see "Safety instructions for installation").

## Wooden worktops

- Seal the cut surfaces of wooden worktops with a suitable heat-resistant sealant to avoid swelling caused by moisture.

Make sure these materials do not get in contact with the surface of the worktop.

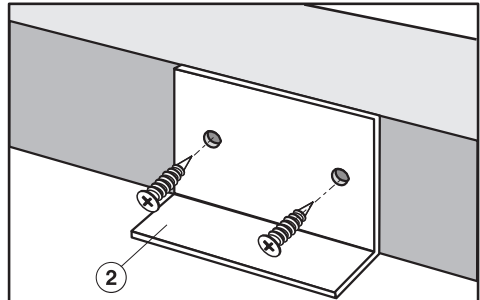
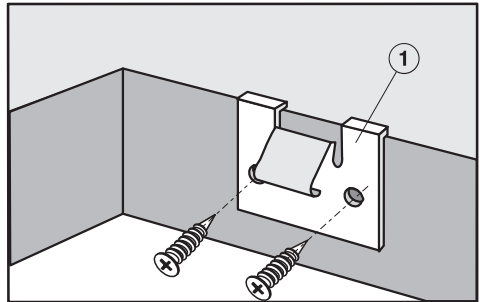

- Position the spring clamps supplied and support brackets (only for cooktops with bevelled edges) on the top edge of the cut-out in the positions marked.
- Fasten the spring clamps ① and the support brackets ② with the provided wood screws 3.5 x 25 mm.



## Granite and marble worktops

Use a strong double-sided tape and silicone for the installation (not supplied).

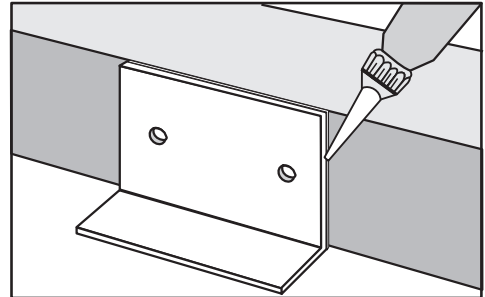
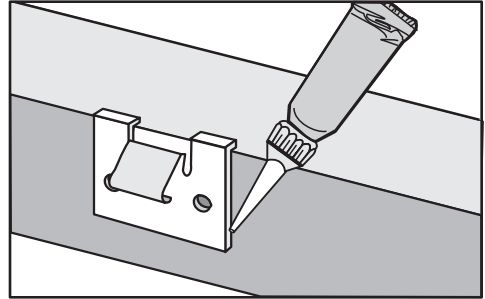
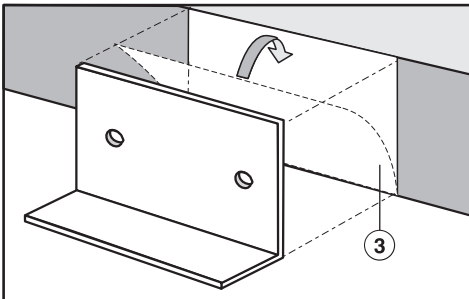
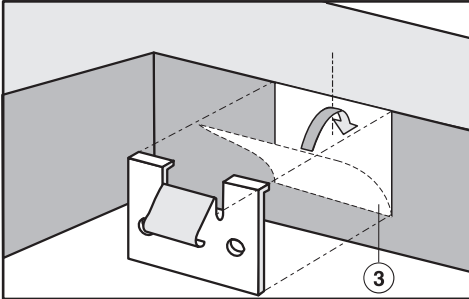

- Coat the side edges and the lower edges of the spring clamps and the support brackets with silicone.

- Fasten the spring clamps and the support brackets (only for cooktops with bevelled edges) with the double-sided tape ③.

The upper edge of the spring clamps and the support brackets have to sit flush with the cut-out.

# Installation

---

## Installing the cooktop

- Feed the cooktop connection cable down through the cut-out.
- Position the cooktop loosely onto the spring clamps.
- Using both hands, press down evenly on the sides of the appliance until it clicks into position. When doing this, make sure that the seal of the appliance sits flush with the worktop on all sides.  
Do not use any additional sealant (e.g. silicone).

If, during installation, you find that the seals on the corners are not flush with the worktop, the corner radius  $\leq R4$  can be carefully scribed to suit.

- Connect the cooktop to the mains.
- Check that the cooktop works.

## Removing the cooktop

If the cooktop is accessible from below, push it out from underneath.

In stubborn cases, or if the cooktop is not accessible from below, use a cooktop lever (available from Miele) to lift up the cooktop. To prevent damage to the worktop, position a cloth or similar under the cooktop lever.

Warning: Do not use a screwdriver to lift up the cooktop as this will damage the appliance.

All electrical work should be carried out by a suitably qualified and competent person, in strict accordance with current local and national safety regulations.

Installation, repairs and other work by unqualified persons could be dangerous. The manufacturer cannot be held liable for unauthorised work.

A damaged cable must be replaced by a suitably qualified electrician with a special connection cable of type H 05 VV-F, available from Miele.

Ensure power is not supplied to the appliance until after installation or repair work has been carried out.

The appliance must only be operated when built-in. This is to ensure that all electrical parts are shielded. Live parts must not be exposed.

Do not connect the appliance to the mains electricity supply by an extension lead. These do not guarantee the required safety of the appliance.

Connection should be made via a suitable isolator which complies with national and local safety regulations, and the On/Off switch should be easily accessible after the appliance has been built in.

If the switch is not accessible after installation (depending on country) an additional means of disconnection must be provided for all poles.

For extra safety it is advisable to protect the appliance with a residual current device (RCD). Please contact a qualified electrician for advice.

When switched off there must be an all-pole contact gap of at least 3 mm in the isolator switch (including switch, fuses and relays).

The appliance is supplied for connection to a 230-240 V, 50 Hz supply with a 3-core cable.

The wires in the mains lead are coloured in accordance with the following code:

Green/yellow = earth

Blue = neutral

Brown = live

(+ black and grey, 5 wire only)

**WARNING**  
**THIS APPLIANCE MUST BE**  
**EARTHED**

Please make sure that the connection data quoted on the data plate matches the household mains supply.

# Electrical connection

The electrical safety of this appliance can only be guaranteed when continuity is complete between it and an effective earthing system, which complies with current local and national safety regulations. It is most important that this basic safety requirement is present and regularly tested and, where there is any doubt, the electrical wiring in the home should be inspected by a qualified electrician. The manufacturer cannot be held liable for the consequences of an inadequate earthing system such as an electric shock.

The manufacturer cannot be held liable for damage which is the direct or indirect result of incorrect installation or connection.

## Wiring diagram

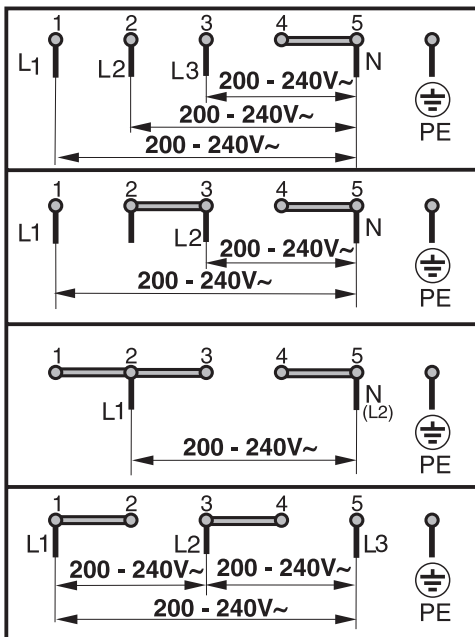

**N.B. This appliance is supplied single phase only in the U.K. / AUS / NZ**

## After sales service, data plate, warranty

---

In the event of any faults which you cannot remedy yourself, please contact:

– Miele (see back of manual for contact details).

When contacting Miele, please quote the model and serial number of your appliance. These are given on the data plate.

Space in which to stick the extra data plate supplied with the appliance. Ensure that the model number is the same as the one on the front of these instructions.

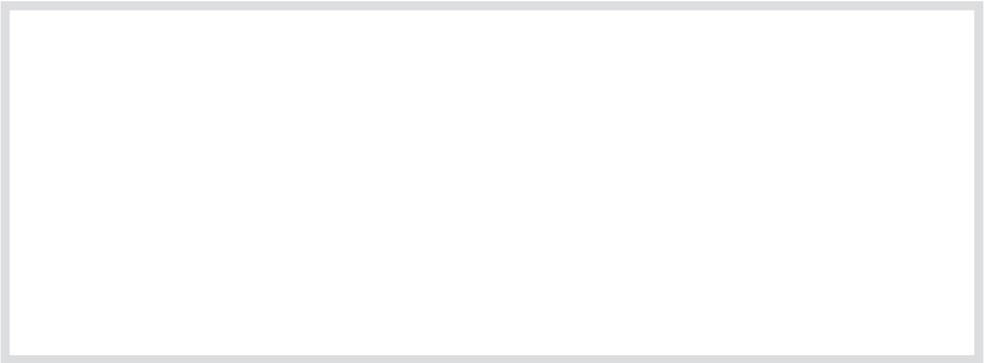

### Warranty

The manufacturer's warranty for this appliance is two years.



**Miele Australia Pty. Ltd.**

ABN 96 005 635 398

**Miele Center and Head Office Melbourne:**

1 Gilbert Park Drive  
Knoxfield, VIC 3180

**Miele Center and Office Melbourne:**

208-210 Coventry Street  
South Melbourne, VIC 3205

**Miele Center and Office Sydney:**

3 Skyline Place  
Frenchs Forest, NSW 2086

**Miele Center and Office Brisbane:**

39 Harvey Street North  
Eagle Farm, QLD 4009

**Miele Center and Office Adelaide:**

83-85 Sir Donald Bradman Drive  
Hilton, SA 5033

**Miele Center and Office Perth:**

205-207 Stirling Highway  
Claremont, WA 6010



**[www.miele.com.au](http://www.miele.com.au)**



**Miele New Zealand Limited  
Miele Center and Head Office**

8 College Hill  
Freemans Bay  
Auckland 1011  
New Zealand  
Telephone: 0800 264 353  
[www.miele.co.nz](http://www.miele.co.nz)

**Miele Global Headquarters  
Germany**

**Miele & Cie. KG**  
Carl-Miele-Straße 29  
33332 Gütersloh  
Federal Republic of Germany

KM 5600



en - AU, NZ

M.-Nr. 07 687 890 / 07