

Operating and installation instructions SmartLine induction hob



To avoid the risk of accidents or damage to the appliance it is **essential** to read these instructions before it is installed and used for the first time.

Warning and Safety instructions	5
Caring for the environment	15
Guide to the appliance	16
Hob.....	16
Controls and display	17
Cooking zones.....	18
How it works	19
Noises.....	19
Power management	20
Pans	21
Before using for the first time	23
Cleaning the SmartLine element for the first time.....	23
Switching on the SmartLine element for the first time	23
Operation	24
Using the appliance.....	24
Switching on the hob	25
Setting the power level.....	25
Switching off a cooking zone	25
Residual heat indicator.....	26
Power level setting - Extended setting range.....	26
PowerFlex cooking area	27
Auto heat-up	28
Booster function.....	29
Keeping warm	30
Setting range	31
Tips on saving energy	32
Timer	33
Minute minder	33
Auto switch off	34
Using both timer functions at the same time	35
Additional functions	36
Stop & Go.....	36
Recall.....	36
Wipe protection	37
Demonstration mode.....	37
Displaying the SmartLine element data	37

Contents

Safety features	38
System lock/safety lock	38
Safety switch-off	39
Overheating protection.....	40
Programming	41
Note for test institutes	44
Cleaning and care	45
Problem solving guide	47
Messages in the display	47
Unexpected behaviour	49
Unsatisfactory results.....	50
General problems or technical faults.....	50
Optional accessories	52
After sales service	53
Contact in the event of a fault	53
Data plate	53
Warranty	53
Installation	54
Safety instructions for installation	54
Safety distances.....	55
Installation notes – surface-mounted	59
Worktop cutout – surface-mounted	61
Spacer bars – surface-mounted.....	64
Installation dimensions – Surface-mounted	65
Installation – surface-mounted	66
Installation notes – flush-fit	68
Worktop cutout – flush-fit.....	70
Spacer bars – flush-fit	73
Installation dimensions – Flush-fit	74
Installation – flush-fit	75
Electrical connection	77
Product data sheets	79

Warning and Safety instructions

This hob complies with all relevant local and national safety requirements. Inappropriate use can, however, lead to personal injury and material damage.

Read the operating and installation instructions carefully before using the hob. They contain important information on safety, installation, use and maintenance. This prevents both personal injury and damage to the hob.

In accordance with standard IEC 60335-1, Miele expressly and strongly advises that you read and follow the instructions in the chapter on installing the hob as well as the safety instructions and warnings.

Miele cannot be held liable for injury or damage caused by non-compliance with these instructions.

Keep these instructions in a safe place and pass them on to any future owner.

Warning and Safety instructions

Correct application

- ▶ This hob is intended for domestic use and use in other similar environments.
- ▶ This hob is not intended for outdoor use.
- ▶ It is intended for domestic use only to cook food and keep it warm. Any other use is not supported by the manufacturer and could be dangerous.
- ▶ This hob is not intended for use by people with reduced physical, sensory or mental capabilities or lack of experience and knowledge, unless they have been given supervision and instruction concerning its use by a person responsible for their safety. They may only use the hob unsupervised if they have been shown how to use it in a safe way. They must be able to recognise and understand the dangers of misuse.

Safety with children

- ▶ Children under 8 years of age must be kept away from the hob unless they are constantly supervised.
- ▶ Children over 8 years of age may use the hob without supervision if its operation has been clearly explained to them and they are able to use it safely. Children must be able to understand and recognise the possible dangers caused by incorrect operation.
- ▶ Children must not be allowed to clean the hob unsupervised.
- ▶ Please supervise children in the vicinity of the hob and do not let them play with it.
- ▶ The hob gets hot when in use and remains hot for a while after being switched off. Keep children well away from the hob until it has cooled down and there is no danger of burning.
- ▶ Danger of burning! Do not store anything which might arouse a child's interest in storage areas above or behind the hob. Otherwise they could be tempted into climbing onto the appliance with the risk of burning themselves.
- ▶ Risk of burning and scalding. Place pots and pans on the cooking zone in such a way that children cannot pull them down and burn themselves.
- ▶ Danger of suffocation! Whilst playing, children may become entangled in packaging material (such as plastic wrapping) or pull it over their head with the risk of suffocation. Keep packaging material away from children.
- ▶ Activate the system lock to ensure that children cannot switch on the hob inadvertently. Use the safety lock when the hob is in use to prevent children from altering the settings selected.

Warning and Safety instructions

Technical safety

- ▶ Unauthorised installation, maintenance and repairs can cause considerable danger for the user. Installation, maintenance and repairs must only be carried out by a Miele authorised technician.
- ▶ Damage to the hob can compromise your safety. Check the hob for visible signs of damage. Do not use the hob if it is damaged.
- ▶ Temporary or permanent operation on an autonomous power supply system or a power supply system that is not synchronised with the mains power supply (e.g. island networks, back-up systems) is possible. A prerequisite for operation is that the power supply system complies with the specifications of EN 50160 or an equivalent standard.

The function and operation of the protective measures provided in the domestic electrical installation and in this Miele product must also be maintained in isolated operation or in operation that is not synchronised with the mains power supply, or these measures must be replaced by equivalent measures in the installation. As described, for example, in the current version of BS OHSAS 18001–2 ISO 45001.

- ▶ The electrical safety of this hob can only be guaranteed when correctly earthed. It is essential that this standard safety requirement is met. If in any doubt please have the electrical installation tested by a qualified electrician.
- ▶ To avoid the risk of damage to the hob, make sure that the connection data on the data plate (voltage and frequency) match the mains electricity supply before connecting it to the mains. Consult a qualified electrician if in doubt.
- ▶ Do not connect the hob to the mains electrical supply by a multi-socket adapter or extension lead. These are a fire hazard and do not guarantee the required safety of the appliance.
- ▶ For safety reasons, this hob may only be used after it has been built in.

Warning and Safety instructions

- ▶ This hob must not be used in a non-stationary location (e.g. on a ship).
- ▶ Never open the casing of the hob.
Touching or tampering with electrical connections or components and mechanical parts is highly dangerous to the user and can cause operational faults.
- ▶ While the hob is under warranty, repairs should only be undertaken by a Miele authorised service technician. Otherwise the warranty is invalidated.
- ▶ Miele can only guarantee the safety of the appliance when genuine original Miele replacement parts are used. Faulty components must only be replaced by Miele spare parts.
- ▶ The hob is not intended for use with an external timer switch or a remote control system.
- ▶ If the plug is removed from the connection cable or if the cable is supplied without a plug, the appliance must be connected to the electrical supply by a suitably qualified electrician.
- ▶ If the mains connection cable is damaged, it must be replaced with a special connection cable by an electrician (see “Electrical connection”).
- ▶ The hob must be disconnected from the mains electricity supply during installation, maintenance and repair work. Ensure that power is not supplied to the appliance until after it has been installed or until any maintenance or repair work has been carried out.
- ▶ Danger of electric shock. Do not use the hob if it is faulty, or if the ceramic surface is cracked, chipped or damaged in any way. Switch it off immediately. Disconnect the hob from the mains electricity supply. Contact Miele Service.

Warning and Safety instructions

- ▶ If the hob is installed behind a cabinet door, do not close the door while the hob is in use. Heat and moisture can build up behind the closed door. This can result in damage to the hob, the housing unit and the floor. Do not close the door until the residual heat indicators go out.
- ▶ In areas which may be subject to infestation by cockroaches or other vermin, pay particular attention to keeping the appliance and its surroundings clean at all times. Any damage caused by cockroaches or other vermin will not be covered by the warranty.

Correct use

- ▶ The hob gets hot when in use and remains hot for a while after being switched off. There is a danger of burning until the residual heat indicators go out.
- ▶ Oil and fat can overheat and catch fire. Do not leave the hob unattended when cooking with oil and fat. If it does ignite do not attempt to put the flames out with water.
Disconnect the hob from the mains and use a suitable fire blanket, saucepan lid, damp towel or similar to smother the flames.
- ▶ Do not leave the SmartLine element unattended whilst it is being used. It should be continually monitored whilst boiling and flash frying.
- ▶ Flames could set the grease filters of a cooker hood on fire. Do not flambé under a cooker hood.
- ▶ Spray canisters, aerosols and other inflammable substances can ignite when heated. Therefore do not store such items or substances in a drawer under the hob. Cutlery inserts must be heat-resistant.
- ▶ Do not heat an empty pan.
- ▶ Do not heat up food in closed containers e.g. tins or sealed jars on the hob, as pressure can build up in the container, causing it to explode.
- ▶ Do not cover the hob, e.g. with a hob cover, a cloth or protective foil. The material could catch fire, shatter or melt if the hob is switched on by mistake or if residual heat is still present.
- ▶ When the appliance is switched on either deliberately or by mistake, or when there is residual heat present, there is the risk of any metal items left on the hob heating up, with the danger of burning. Depending on the material, other items left on the hob could also melt or catch fire. Damp pan lids might adhere to the ceramic surface and be difficult to dislodge. Do not use the appliance as a resting place. Switch the cooking zones off after use.

Warning and Safety instructions

- ▶ You could burn yourself on the hot hob. Protect your hands with heat-resistant pot holders or gloves when handling hot pots and pans. Do not let them get wet or damp, as this causes heat to transfer through the material more quickly with the risk of scalding or burning yourself.
- ▶ When using an electrical appliance, e.g. a hand-held food blender, near the hob, ensure that the cable of the electrical appliance cannot come into contact with the hot hob. The insulation on the cable could become damaged.
- ▶ Grains of salt, sugar and sand (e.g. from cleaning vegetables) can cause scratches if they get under pan bases. Make sure that the ceramic surface is clean before placing pans on it.
- ▶ Even a light object can cause damage in certain circumstances. Do not drop anything on the ceramic surface.
- ▶ Placing hot pans on the sensors and indicators could damage the electronics underneath. Do not place hot pans on the sensors or indicators.
- ▶ Do not allow solid or liquid sugar, or pieces of plastic or aluminium foil to get onto the hob when it is hot, as they can damage the ceramic surface when it cools down. If this should occur, switch off the appliance and scrape off all the sugar, plastic or aluminium residues whilst still hot, using a shielded scraper blade suitable for use on glass. Wear oven gloves when doing this. Allow the ceramic surface to cool down and then clean it with a suitable ceramic hob cleaning agent.
- ▶ Pans which boil dry can cause damage to the ceramic glass. Do not leave the hob unattended whilst it is being used.
- ▶ Only use pots and pans with smooth bases. Rough bases will scratch the ceramic glass.
- ▶ Lift pans into position on the hob. Sliding them into place can cause scuffs and scratches.

Warning and Safety instructions

- ▶ Because induction heating works so quickly, the base of the pan could, under certain circumstances, heat up to the temperature at which oil or fat self-ignites within a very short time. Never leave the hob unattended during use!
- ▶ Heat oil or fat for a maximum of one minute. Never use the Booster function to heat oil or fat.
- ▶ For people fitted with a heart pacemaker: Please note that the area immediately surrounding the hob is electromagnetically charged. It is very unlikely to affect a pacemaker. However, if in any doubt, consult the manufacturer of the pacemaker or your doctor.
- ▶ To prevent damage to items which are susceptible to electromagnetic fields, e.g. credit cards, digital storage devices, pocket calculators, etc, do not leave them in the immediate vicinity of the hob.
- ▶ Metal utensils stored in a drawer under the hob can become hot if the appliance is used intensively for a long time.
- ▶ The hob is fitted with a cooling fan. If a drawer is fitted directly underneath the hob, ensure that there is sufficient space between the drawer and its contents and the underside of the hob in order to ensure sufficient ventilation for the hob.
- ▶ If a drawer is fitted directly underneath the hob, do not store any pointed or small items, paper, serviettes, etc. in the drawer. They could get in through the ventilation slots or be sucked into the casing by the fan and damage the fan or impair cooling.
- ▶ Never use two pans on a cooking zone, extended zone or Power-Flex zone at the same time.
- ▶ If the cookware only partially covers a cooking or extended zone, the handle could become very hot.
Always place cookware in the middle of a cooking or extended zone!
- ▶ The induction generators could be damaged or even destroyed if you use an induction adapter plate for cookware. Do not use induction adapter plates.

Warning and Safety instructions

Cleaning and care

- ▶ Do not use a steam cleaning appliance to clean this hob. The steam could reach electrical components and cause a short circuit.
- ▶ If the hob is built in over a pyrolytic oven, the hob should not be used whilst the pyrolytic process is being carried out, as this could trigger the overheating protection mechanism on the hob (see relevant section).
- ▶ Miele will guarantee to supply functional spare parts for a minimum of 10 years and up to 15 years following the discontinuation of your CombiSet.

Disposal of the packing material

The packaging is designed to protect the appliance from damage during transportation. The packaging materials used are selected from materials which are environmentally friendly for disposal and should be recycled.

Recycling the packaging reduces the use of raw materials in the manufacturing process and also reduces the amount of waste in landfill sites.

Disposing of your old appliance

Electrical and electronic appliances often contain valuable materials. They also contain specific materials, compounds and components, which were essential for their correct function and safety. These could be hazardous to human health and to the environment if disposed of with your domestic waste or if handled incorrectly. Please do not, therefore, dispose of your old appliance with your household waste.



Please dispose of it at your local community waste collection / recycling centre for electrical and electronic appliances, or contact your dealer or Miele for advice. You are also responsible for deleting any personal data that may be stored on the appliance being disposed of. Please ensure that your old appliance poses no risk to children while being stored prior to disposal.

Guide to the appliance

Hob

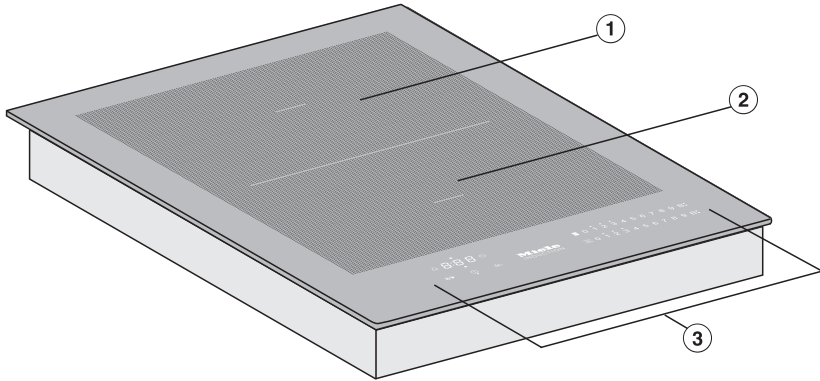

- ① PowerFlex cooking zone with TwinBooster can be combined with PowerFlex cooking zone ② to form PowerFlex cooking area
- ② PowerFlex cooking zone with TwinBooster
- ③ Controls and indicators

Controls and display

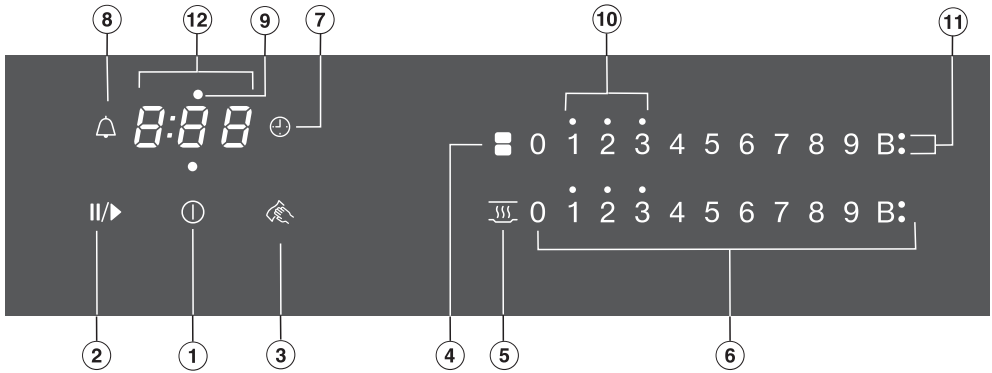

Sensor controls

- ① Hob On/Off
- ② Stop & Go
To stop/start a cooking process in progress
- ③ Wipe protection
To lock the sensor controls
- ④ PowerFlex cooking zones
For manual connection/disconnection of PowerFlex cooking zones
- ⑤ Keeping warm
To activate/deactivate the Keeping warm function
- ⑥ Numerical display
 - To set the power level
 - To set the times
- ⑦ Auto switch off
Switches the cooking zones off automatically
- ⑧ Minute minder

Guide to the appliance

Displays/indicator lights

⑨ Cooking zone allocation auto switch off
Auto switch off for the cooking zone is activated

⑩ Residual heat

⑪ Booster function
Booster function is activated

⑫ Timer display

0:00 to Time

9:59

LOC System lock/safety lock is activated

dE Demo mode is activated

Cooking zones

Cooking zone	Ø in cm ¹	Rating in watts for 230 V ²
①	15–23	Normal 2100 TwinBooster, level 1 3000 TwinBooster, level 2 3650
②	15–23	Normal 2100 TwinBooster, level 1 3000 TwinBooster, level 2 3650
① + ②	22–23/ 15 x 23–23 x 39	Normal 3150 TwinBooster, level 1 3400 TwinBooster, level 2 3650
		Total 3650

¹ Cookware with a base diameter within the given range may be used.

² The power given may vary depending on the size and material of the cookware used.

An induction coil is located under each induction cooking zone. The coil creates a magnetic field that reacts directly with the base of the pan and heats it up. The cooking zone itself is heated up indirectly by the heat given off by the pan.

An induction cooking zone only works when cookware with a magnetic base is placed on it (see “Cookware”). Induction automatically recognises the size of the cookware.



Risk of burning due to hot items.

When the appliance is switched on either deliberately or by mistake, or when there is residual heat present, there is the risk of metal items placed on the hob heating up.

Do not use the appliance as a resting place for anything.

After use, switch the hob off with the ① sensor control.

Noises

When using an induction hob, the following noises can occur in the pan, depending on what it is made of and how it has been constructed.

Buzzing on the higher power settings. This will decrease or cease altogether when the power setting is reduced.

If the pan base is made of layers of different materials (e.g. in a sandwiched base), it might emit a crackling sound.

Whistling might occur if linked zones (see “Operation - Booster”) are being used at the same time, and the pans also have bases made of layers of different materials.

You might hear a clicking sound from the electronic switches, especially on lower settings.

A whirring sound, when the cooling fan comes on. This switches on to protect the electronics when the hob is being used intensively. The cooling fan may continue to run after the appliance has been switched off.

How it works

Power management

The hob has a maximum total permitted power consumption which cannot be exceeded for safety reasons.

The two cooking zones on the hob are interconnected. This allows additional power to be transferred from one cooking zone to another.

The previously set setting has precedence and the hob will operate with this level.

If power is transferred from one cooking zone to the linked cooking zone, the power for the first cooking zone must be reduced.

The possible values for the maximum total permitted power consumption can be found in "Overview – Cooking zone data".

If the new cooking zone requires more power than the first cooking zone can provide, this may result in the following consequences for the first cooking zone:

- The power level is reduced.
- Auto heat-up will be deactivated. Cooking continues at the set level. If the power is not sufficient, the power level will be reduced again.
- The Booster function is deactivated.
- The cooking zone is switched off.

If the most recently set power level is reduced or the Booster function is switched off, the power level for the linked cooking zone can be increased again.

Suitable pans

- stainless steel pans with a magnetic base
- enamelled steel pans
- cast iron pans

Please be aware that the properties of the pan base can affect the evenness with which the food heats up (e.g. when making pancakes). The base of the pan must be able to distribute the heat evenly. A sandwich base made of stainless steel is particularly suitable.

Unsuitable pans.

- stainless steel pans without a magnetic base
- aluminium or copper pans
- glass, ceramic or earthenware pots and pans

Testing pans

To test whether a pan is induction-compatible, hold a magnet to the base of the pan. If the magnet sticks, the pan is generally suitable.

No pan/unsuitable pan display

The set power level flashes in the numerical keybank for the cooking zone

- if the zone has been switched on without a pan in place, or if the pan is unsuitable (non-magnetic base)
- if the diameter of the base of the pan is too small
- if the pan is taken off the cooking zone when it is switched on

If a suitable pan is placed on the cooking zone within 3 minutes, the flashing power level will go out and you can continue as normal.

If no pan or an unsuitable pan is placed on the cooking zone, the cooking zone will switch off automatically after 3 minutes.

Pans

Tips

- To make optimum use of the cooking zones, choose cookware with a suitable base diameter (see “Overview – Cooking zone data”). If the pan is too small it will not be recognised.
 - Position the cookware as centrally as possible on the relevant cooking zone/cooking area.
 - Use only pots and pans with smooth bases. Rough bases can scratch the ceramic glass.
 - Always lift cookware to move it. This will help prevent scratching. If any scratches do appear as a result of cookware being pushed around, this will not affect the function of the hob. These scratches are normal signs of use and are not grounds for making a complaint.
- Please note that the maximum diameter quoted by manufacturers often refers to the diameter of the top rim of the pots and pans. The diameter of the base (generally smaller) is more important.

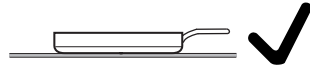

- Where possible, use pans with vertically straight sides. If a pan has angular sides, induction also acts on the sides of the pan. The sides of the pan may discolour or the coating may peel off.

Before using for the first time

- Please stick the extra data plate for the appliance supplied with this documentation in the space provided in the “After sales service” section of this booklet.
- Remove any protective wrapping and stickers.

Cleaning the SmartLine element for the first time

- Before using for the first time, clean the hob with a damp cloth only and then wipe dry.

Switching on the SmartLine element for the first time

The metal components have a protective coating. Smells and possibly some vapours may occur when the SmartLine element is used for the first time. The heating of the induction coils also causes odours in the first few hours of operation. With each subsequent use, the odour is reduced until it disappears completely.

The smell and any vapours given off do not indicate a faulty connection or appliance and they are not hazardous to health.

Please note that the heating up time on induction hobs is very much shorter than on conventional hobs.

Operation

Using the appliance

This SmartLine element is equipped with electronic sensor controls which react to finger contact. For safety reasons, in order to switch the appliance on, the On/Off ① sensor needs to be touched for a little longer than the other sensors.

Each time you touch a sensor, an audible tone sounds.

Only the printed On/Off ① symbol is visible when the SmartLine element is switched off. The other sensor controls light up when the SmartLine element is switched on.

 Malfunction due to dirty and/or covered sensor controls.

If the sensor controls are dirty or covered this could cause them to fail to react, to activate a function or even to switch the appliance off automatically (see “Safety features”, “Safety switch-off”). Placing hot pans on the sensor controls/indicators can damage the electronic unit underneath.

Keep the sensor controls and indicators clean and do not place anything on top of them. Do not place hot pans on them.

 Risk of fire with overheated food. Unattended food can overheat and catch alight. Do not leave the hob unattended whilst it is being used.

Please note that the heating up time on induction hobs is very much shorter than on conventional hobs.

Switching on the hob

- Touch the ① sensor.

Other sensors will light up.

If no further entry is made, the hob will switch itself off after a few seconds for safety reasons.

Setting the power level

Permanent pan recognition is activated as standard (see “Programming”). When the hob is switched on and you place a pan on one of the cooking zones, all the sensors for that cooking zone's numerical keybank will light up.

- Place a pan on the cooking zone you want to use.
- Touch the appropriate number sensor for the power level you want.

Switching off a cooking zone

- To switch off a cooking zone, touch the 0 sensor for that cooking zone.
- To switch off the hob and all the cooking zones, touch the ① sensor.

Operation

Residual heat indicator

If the cooking zone is still hot, the residual heat indicator will light up after the zone has been switched off. Depending on the temperature, a dot will appear above power levels 1, 2 and 3.

The dots of the residual heat indicator will go out one after another as the cooking zone cools down. The last dot only goes out when the cooking zone is safe to touch.



Risk of burning due to hot cooking zones.

The cooking zones will be hot after use.

Do not touch the cooking zones while the residual heat indicators are on.

Power level setting - Extended setting range

- Touch the numerical keybank in between two number sensors.

The numbers to the left and right of the interim level light up brighter than the others.

Example:

If you have set power level 7, the numbers 7 and 8 will be brighter than the other numbers.

PowerFlex cooking area

The PowerFlex cooking zones combine automatically to form a PowerFlex cooking area when you place sufficiently large items of cookware on them (see “Guide to the appliance – Hob”). Settings for the linked cooking area are controlled by the numerical display of the front or left PowerFlex cooking zone (depending on model). The PowerFlex cooking zones can also be switched on and off manually:

- Touch the  sensor control.

Positioning cookware

Refer to the cooking zone data for your hob model for information about cookware sizes and the corresponding positions (see “Overview – Cooking zone data”).

PowerFlex cooking zone

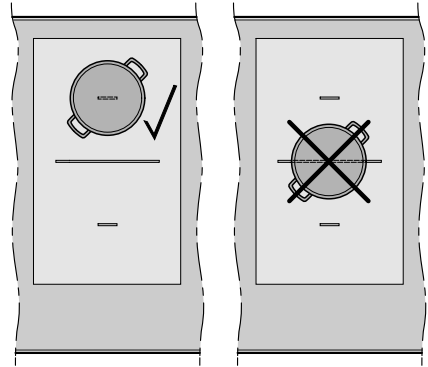

PowerFlex cooking area (pot)

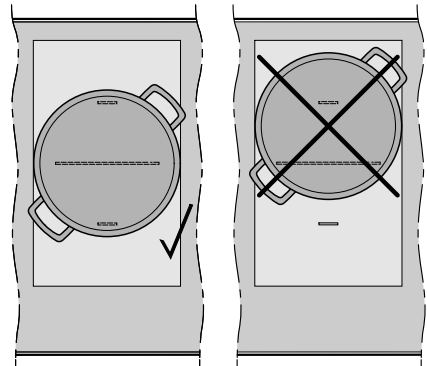

PowerFlex cooking area (oven dish)

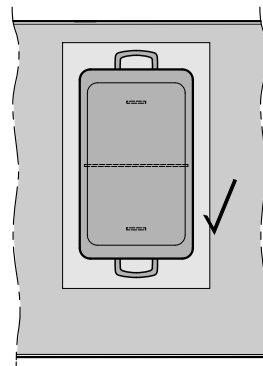

Operation

Auto heat-up

When Auto heat-up has been activated, the cooking zone switches on automatically at the highest setting and then switches to the continued cooking setting which you have previously selected. The heat-up time depends on which continued cooking setting has been chosen (see chart).

Activating Auto heat-up

- Touch the sensor for the continued cooking setting you want until a tone sounds and the sensor starts to pulsate.

During the heat-up time (see chart), the continued cooking level set will pulsate. With extended power levels (see “Programming”), the sensors for the power levels in front of and after the interim power level will pulsate if an extended power level setting has been selected.

Altering the continued cooking setting will deactivate Auto heat-up.

Deactivating Auto heat-up

- Touch the sensor for the continued cooking setting.

or

- Set another power level.

Continued cooking setting*	Heat-up time [min : sec]
1	Approx. 0:15
1.	Approx. 0:15
2	Approx. 0:15
2.	Approx. 0:15
3	Approx. 0:25
3.	Approx. 0:25
4	Approx. 0:50
4.	Approx. 0:50
5	Approx. 2:00
5.	Approx. 5:50
6	Approx. 5:50
6.	Approx. 2:50
7	Approx. 2:50
7.	Approx. 2:50
8	Approx. 2:50
8.	Approx. 2:50
9	—

* The continued cooking settings with a dot after the number are only available if the power level range has been extended (see “Programming”).

Booster function

The cooking zones are equipped with a TwinBooster.

When the Booster function is activated, the power is boosted so that large quantities can be heated up quickly, e.g. when boiling water for cooking pasta. The boost in power is active for a maximum of 15 minutes.

When the Booster function is activated, the settings for active cooking zones may be changed, see “Induction – Power management”.

You can use the Booster function with a maximum of 1 cooking zone or the PowerFlex cooking area.

If the Booster function is switched on when

- no power level has been selected, the cooking zone will revert automatically to level 9 at the end of the Booster time or if the Booster function is switched off before this.
- a power level has been selected, the cooking zone will revert automatically to the power level selected at the end of the Booster time or if the Booster function is switched off before this.

Activating the TwinBooster

Level 1

- Place the cookware on the cooking zone you want to use.
- Select a power level if necessary.
- Touch the **B** sensor control.

The indicator light ● for TwinBooster level 1 lights up.

Level 2

- Place the cookware on the cooking zone you want to use.
- Select a power level if necessary.
- Touch the **B** sensor control twice.

The indicator light ● for TwinBooster level 2 lights up.

Deactivating TwinBooster

- Touch the **B** sensor control repeatedly until the indicator lights go out.

or

- Set another power level.

Operation

Keeping warm

This function is for keeping food warm which has just been cooked and is still hot. It is not for reheating food that has gone cold.

The maximum duration for keeping food warm is 2 hours.

- Only use pans for keeping food warm. Cover the pan with a lid.
- Stir firm or viscous food (mashed potatoes, stew) occasionally.
- Nutrients are lost when food is cooked, and continue to diminish when food is kept warm. The longer food is kept warm, the greater the loss of nutrients. Try to ensure that food is kept warm for as short a time as possible.

Activating/deactivating the keeping warm function

- Touch the  sensor for the cooking zone you wish to use.

Setting range

The hob is programmed with 9 power levels at the factory. If you wish to fine-tune a setting, you can extend the power setting range to 17 power levels (see “Programming”).

	Setting range	
	Default setting (9 power levels)	Extended settings (17 power levels)
Melting butter Dissolving gelatine Melting chocolate	1-2	1-2.
Making milk puddings	2	2-2.
Warming small quantities of liquid Cooking rice	3	3-3.
Defrosting frozen vegetables	3	2.-3
Making porridge	3	2.-3.
Warming liquid and semi-solid foods Making omelettes or lightly frying eggs Steaming fruit	4	4-4.
Cooking dumplings	4	4-5.
Steaming vegetables and fish	5	5
Defrosting and reheating frozen food	5	5-5.
Gently frying eggs (without overheating the fat)	6	5.-6.
Bringing large quantities of food to the boil, e.g. casseroles. Thickening custard and sauces, e.g. hollandaise	6-7	6.-7
Gently braising meat, fish and sausages (without overheating the fat)	6-7	6.-7.
Frying pancakes, potato fritters etc.	7	6.-7
Cooking stew	8	8-8.
Boiling large quantities of water Bringing to the boil	9	9

These settings should only be taken as a guide. The power of the induction coils will vary depending on the size and material of the pan. For this reason, it is possible that the settings will need to be adjusted slightly to suit your pans. As you use the hob, you will get to know which settings suit your pans best. When using new pans that you are not familiar with, set the power level below the one specified.

Tips on saving energy

- Use a lid whenever possible to minimise heat loss.
- Select a smaller pan when cooking small quantities. A smaller pan uses less energy than a larger pan with very little in it.
- Cook with as little water as possible.
- Once food has come to the boil or the oil in the pan is hot enough for frying, reduce the heat to a lower setting.
- Use a pressure cooker to reduce cooking times.

The SmartLine element has to be switched on if you wish to use the timer.

The timer can be used for the following 2 functions:

- For setting the minute minder
- For automatically switching off a cooking zone/heater element/Tepan Yaki zone

You can use the functions simultaneously.

A duration of between 1 minute (0:01) and 9 hours 59 minutes (9:59) can be set.

Durations of up to 59 minutes are shown in minutes (0:59) and durations of more than 60 minutes are shown in hours and minutes. Durations are entered in the order of hours, followed by minutes in tens and then units.

Example:

59 minutes = 0:59 hours,

Enter: 5-9

80 minutes = 1:20 hours,

Enter: 1-2-0

After the first number has been entered, the timer display will light up constantly. After the second number has been entered, the first number will move to the left. After the third number has been entered, the first and second numbers will move to the left.

Minute minder

The minute minder is set using the numerical display for the left or front left cooking zone (depending on model).

Setting the minute minder

- Touch the  sensor control.

The timer display flashes.

- Set the required duration.

Touch the  sensor control or wait 10 seconds to start the minute minder.

Changing the minute minder duration

- Touch the  sensor control.

The timer display flashes.

- Set the required duration.

Deleting the minute minder duration

- Touch the  sensor control.

- Touch the  on the numerical display.

Timer

Auto switch off

You can set a time after which a cooking zone will switch off automatically. This function can be used for all cooking zones at the same time.

If the time programmed is longer than the maximum operating time allowed, the cooking zone will be switched off by the safety switch-off function (see “Safety features – Safety switch-off”).

The switch-off time is set on the numerical display for each cooking zone you want to switch off automatically.

Setting the switch-off time

- Select a power level for the cooking zone you require.
- Touch the  sensor control.

The timer display flashes.

- Set the required duration.

Touch the  sensor control or wait 10 seconds to start the switch-off time.

The cooking zone allocation auto switch off indicator light pulsates.

- To set a switch-off time for another cooking zone, follow the same steps as described above.

If more than one switch-off time is programmed, the shortest time left will be displayed, and the corresponding indicator light will pulsate. The other indicator lights will light up constantly.

- If you want to show the time left for other cooking zones in the background, touch the  sensor control of the desired cooking zone.

Changing the switch-off time

- Touch the  sensor control repeatedly until the indicator light for the cooking zone you require pulsates.

The timer display flashes.

- Set the required duration.

Deleting the switch-off time



- Touch the  sensor control repeatedly until the indicator light for the cooking zone you require pulsates.

The timer display flashes.

- Touch the  sensor control on the numerical display.

Using both timer functions at the same time

If you use both functions simultaneously, the shortest time is always displayed. The  sensor control (minute minder) or the indicator light of the cooking zone with the shortest time pulsates.

- Touch the  or  sensor control if you want to show the times left counting down in the background.
- If a switch-off time has been programmed for several cooking zones, touch the  sensor control repeatedly until the indicator light for the required cooking zone pulsates.

Additional functions

Stop & Go

When Stop & Go is activated, the power of all cooking zones in use is reduced to power level 1.

The cooking zone power levels and the timer settings cannot be altered; the hob can only be switched off. The minute minder, switch-off, Booster and heat-up times continue to run.

When Stop & Go is deactivated, the cooking zones will operate at the power level previously selected.

If the function is not deactivated within 1 hour, the hob will switch off.

Activating/Deactivating

- Touch the II/▶ sensor control.

Recall

If the SmartLine element is accidentally switched off during use, you can use this function to restore all the settings.

The SmartLine element must be switched on again within 10 seconds.

- Switch the SmartLine element on again.

The previously set power levels flash.

- Press one of the flashing power level indicators immediately.

The appliance will continue to operate using the settings selected previously.

Wipe protection

You can lock the SmartLine element sensor controls for 20 seconds in order to remove soiling, for example. The ① sensor control is not locked.

Activating

- Touch the  sensor control.

The time counts down in the timer display.

Deactivating

- Touch the  sensor control until the timer display goes out.

Demonstration mode

This function enables the SmartLine element to be demonstrated in show-rooms without heating up.

Activating/deactivating demonstration mode

- Switch the SmartLine element on.
- Touch the 0 sensor on any of the numerical keybanks.
- Then touch the 0 and 2 sensors at the same time for 6 seconds.

In the timer display, *dE* flashes alternately with *0n* (demonstration mode activated) or *0FF* (demonstration mode deactivated) for a few seconds.

Displaying the SmartLine element data

The model designation and software version of the SmartLine element can be displayed. To do this there must not be any pots or pans on the SmartLine element.

Model designation

- Switch the SmartLine element on.
- Touch the 0 sensor control on any of the numerical keybanks.
- Then touch the 0 and 4 sensor controls at the same time.

The timer display shows 2 numbers flashing alternately:

12 flashes alternately with *34* = CS 1234

Software version

- Switch the SmartLine element on.
- Touch the 0 sensor control on any of the numerical keybanks.
- Then touch the 0 and 3 sensor controls at the same time.

Numbers will appear in the timer display:

2:00 = software version

Safety features

System lock/safety lock

The safety lock function is deactivated if there is a mains outage.

Your SmartLine element is equipped with a system lock and a safety lock to prevent the element from being switched on or any settings being altered by mistake.

The **system lock** is activated when the SmartLine element is switched off. If the system lock is activated, the element cannot be switched on and the timer cannot be used. A set minute minder time continues to count down. The SmartLine element is programmed so that the system lock must be activated manually. It can be programmed to be activated automatically 5 minutes after the SmartLine element has been switched off (see “Programming”).

The **safety lock** is activated when the SmartLine element is switched on. When the safety lock is activated, the element can be operated only under certain conditions:

- Selected power levels cannot be changed.
- A set minute minder time can be modified.
- The SmartLine element can only be switched off.

If an unavailable sensor control is touched whilst the system lock or safety lock is activated *LDC* will appear in the timer display for a few seconds and a tone will sound.

Activating the system lock

- Touch the  sensor for 6 seconds.



The seconds can be seen counting down in the timer display. When this time has elapsed *LDC* will appear in the timer display. The system lock has been activated.

Deactivating the system lock

- Touch the  sensor for 6 seconds.



LDC will appear briefly in the timer display and then the seconds will be seen counting down. The system lock is deactivated once the time has elapsed.

Activating the safety lock

- Touch and hold the  and  sensors at the same time for 6 seconds.

The seconds can be seen counting down in the timer display. When this time has elapsed *LDC* will appear in the timer display. The safety lock is activated.

Deactivating the safety lock

- Touch and hold the  and  sensors at the same time for 6 seconds.

LDC will appear briefly in the timer display and then the seconds will be seen counting down. Once the time has elapsed, the lock function is deactivated.

Safety switch-off

Sensor controls are covered

Your SmartLine element will turn off automatically if one or several of the sensor controls remain covered for longer than 10 seconds, for example, by finger contact, food boiling over or by an object such as an oven glove or tea towel. ① flashes briefly above the \mathcal{L} sensor control and a tone will sound. If you remove the obstruction and/or clean the appliance, \mathcal{L} goes out and the SmartLine element is ready for use again.

Excessive operating time

The safety switch-off mechanism is triggered automatically if a cooking zone is heated for an unusually long period of time. This time depends on the power level selected. If it has been exceeded, the cooking zone switches off and the residual heat indicator appears. If you switch the cooking zone on and off again, it is ready for operation again.

The hob is programmed to safety setting 0 at the factory. If necessary, a higher safety setting with a shorter maximum operating time can be set (see chart).

Power level*	Maximum operating time [h:min]		
	Safety setting		
	0**	1	2
1	10:00	8:00	5:00
1.	10:00	7:00	4:00
2/2.	5:00	4:00	3:00
3/3.	5:00	3:30	2:00
4/4.	4:00	2:00	1:30
5/5.	4:00	1:30	1:00
6/6.	4:00	1:00	0:30
7/7.	4:00	0:42	0:24
8	4:00	0:30	0:20
8.	4:00	0:30	0:18
9	1:00	0:24	0:10

* The power levels with a dot after the number are only available if the power level range has been extended (see "Setting range").

** Factory default setting

Safety features

Overheating protection

All the induction coils and cooling elements for the electronics are fitted with an overheating protection mechanism. Before the induction coils and/or cooling elements get too hot, the overheating protection mechanism cuts in in one of the following ways:

Induction coils

- Any Booster function in operation will be switched off.
- The set power level will be reduced.
- The cooking zone turns off automatically. *Err* will flash alternately with *044* in the timer display.

You can use the cooking zone again as usual when the fault code has gone out.

Cooling elements

- Any Booster function in operation will be switched off.
- The set power level will be reduced.
- The cooking zones switch off automatically.

The affected cooking zones can only be used again as usual once the cooling element has cooled down to a safe level.

The overheating protection may be activated under the following circumstances:

- The pan being heated is empty.
- Fat or oil is being heated on a high power level.
- There is insufficient ventilation to the underside of the hob.
- A hot cooking zone is switched on after an interruption to the power supply.



If, despite removing the cause, the overheating protection mechanism triggers again, contact the Customer Service Department.

You can adapt the programming of the SmartLine element to your personal needs. Several settings can be altered in succession.

After accessing the programming mode, the  symbol and *PC* will appear in the timer display. After a few seconds *P:01* (programme 01) will flash alternately with *C:01* (code) in the timer display.

Changing the programming

Accessing programming mode

- **With the SmartLine element switched off**, press and hold the  and **II/▶** sensor controls together until the  symbol lights up and *PC* is shown in the timer display.

Setting the programme

For a two-digit programme number you need to first set the tens position.

- Touch the  sensor control repeatedly until the programme number you want appears in the display, or touch the appropriate number on the numerical display.

Setting the code

- Touch the  sensor control repeatedly until the code number you want appears in the display, or touch the appropriate number on the numerical display.

Saving the settings

- While the programme is showing in the display (e.g. *P:01*) touch the  sensor control until the indicators go out.

To avoid saving the settings

- Touch the **II/▶** sensor control until the indicators go out.

Programming

Programme ¹		Code ²	Settings
P:01	Demo mode	C:00	Demo mode off
		C:01	Demo mode on ³
P:03	Factory default setting	C:00	Do not restore factory default settings
		C:01	Restore factory default settings
P:04	Number of cooking zone power levels	C:00	9 power levels + Booster
		C:01	17 power levels + Booster ⁴
P:06	Audible tone when a sensor control is touched	C:00	Off ⁵
		C:01	Quiet
		C:02	Medium
		C:03	Loud
P:07	Timer buzzer	C:00	Off
		C:01	Quiet
		C:02	Medium
		C:03	Loud
P:08	System lock	C:00	System lock can only be activated manually
		C:01	System lock activated automatically
P:09	Maximum operating time	C:00	Safety setting 0
		C:01	Safety setting 1
		C:02	Safety setting 2

Programme ¹		Code ²	Settings
P:12	Sensor controls reaction speed	C:00	Slow
		C:01	Normal
		C:02	Fast
P:15	Permanent pan recognition	C:00	Permanent pan recognition off
		C:01	Permanent pan recognition on

¹ Unlisted programmes are not assigned.

² The factory-set code is shown in bold.

³ After the hob has been switched on *dE* appears in the timer display for a few seconds.

⁴ In the text and charts, the extended power levels are shown with a dot after the number for better understanding.

⁵ The audible tone for the On/Off sensor control cannot be switched off.

Note for test institutes

Test food acc. to EN 60350-2

9 power levels are programmed at the factory.

For testing in accordance with the above standard, programme the hob to the extended power level setting.

Test food	Ø Pan base (mm)	Lid	Power level	
			Pre-heat	Cooking
Heating oil up	150	No	–	1–2
Pancakes	180 (Sandwich base)	No	9	5.–7.
Frying deep frozen chips	According to the standard	No	9	9

 Risk of burning due to hot cooking zones.

The cooking zones will be hot after use.

Switch the hob off.

Allow the cooking zones to cool down before cleaning the hob.

 Risk of damage due to moisture ingress.

The steam from a steam cleaning appliance could reach live electrical components and cause a short circuit.

Do not use a steam cleaner to clean the hob.

All surfaces could be discoloured or damaged if unsuitable cleaning agents are used. All surfaces are susceptible to scratching.

Remove all cleaning agent residues immediately.

Never use abrasive sponges or cleaning agents.

Allow the SmartLine element to cool down before cleaning.

- Clean the SmartLine element and accessories after each use.
- Dry the SmartLine element thoroughly after every cleaning to avoid limescale residue.

Unsuitable cleaning agents

To avoid damaging the surfaces of the appliance, do not use:

- washing-up liquid
- cleaning agents containing soda, alkalines, ammonia, acids or chlorides
- cleaning agents containing descaling agents
- stain and rust removers
- abrasive cleaning agents, e.g. powder cleaners and cream cleaners
- solvent-based cleaning agents
- dishwasher cleaner
- oven sprays
- glass cleaning agents
- hard, abrasive brushes or sponges (e.g. pot scourers) or sponges which have been previously used and still contain abrasive cleaning agents
- melamine eraser blocks

Cleaning and care

 Risk of damage by pointed objects.

The seal between the SmartLine element and the worktop could suffer damage.

Do not use pointed objects for cleaning.

Not all soiling and residues can be removed using a solution of washing-up liquid.

An invisible film can develop that can lead to discolouration of the glass ceramic surface. This discolouration cannot be removed.

Clean the ceramic surface regularly with a proprietary ceramic glass cleaning agent.

- Remove any coarse soiling with a damp cloth and more stubborn soiling with a shielded scraper blade suitable for use on glass.
- Then clean the ceramic glass surface with the Miele ceramic and stainless steel hob cleaner (see “optional accessories”) or with a proprietary ceramic glass cleaner applied with kitchen paper or a clean cloth. Do not apply the cleaner while the hob is still hot, as this can result in marking. Please follow the cleaning agent manufacturer's instructions.
- Finally wipe the glass ceramic surface with a damp cloth and polish with a soft, dry cloth.

Residues can burn onto the hob the next time it is used and cause damage to the glass ceramic surface. Ensure that all cleaning agent residues are removed.

- **Spots** caused by limescale, water and aluminium residues (spots with a metallic appearance) can be removed using Miele's ceramic and stainless steel hob cleaner.

 Danger of burning due to hot surfaces.

The surfaces get hot during cooking. Wear oven gloves when removing residues of sugar, plastic or aluminium foil from a hot ceramic surface with a shielded scraper blade.

- Should any **sugar, plastic or aluminium foil** spill or fall onto the hot ceramic surface while it is in use, switch off the cooking zone.
- Then carefully scrape off these residues **immediately** whilst they are still hot, using a scraper blade suitable for use on glass.
- Afterwards, clean the ceramic surface in its cooled state, as described above.

Many malfunctions and faults that can occur in daily operation can be easily remedied. Time and money will be saved because a service call will not be needed.

The following guide may help you to find the reason for a malfunction or a fault, and to correct it.

Messages in the display

Problem	Cause and remedy
After the SmartLine element has been switched on or a sensor control has been touched, <i>LDC</i> appears in the timer display for a few seconds.	The system lock or safety lock is activated. <ul style="list-style-type: none"> ■ Deactivate the system lock or safety lock (see “System lock / Safety lock”).
After the SmartLine element has been switched on <i>dE</i> appears in the timer display for a short while. The SmartLine element does not heat up.	The SmartLine element is in demonstration mode. <ul style="list-style-type: none"> ■ Touch the 0 and 2 sensor controls at the same time until <i>dE</i> flashes alternately with <i>OFF</i> in the timer display.
The SmartLine element has switched off automatically. When the element is switched back on, <i>L</i> appears above the On/Off sensor control ①.	One or more of the sensor controls are covered, e.g. by finger contact, food boiling over or an object. <ul style="list-style-type: none"> ■ Clean off any dirt and/or remove the object (see “Safety features” – “Safety switch-off”).
<i>Err</i> flashes alternately with <i>30</i> in the timer display and a tone will sound.	The SmartLine element is connected incorrectly. <ul style="list-style-type: none"> ■ Disconnect the SmartLine element from the mains. ■ Contact Miele Service.
<i>Err</i> will flash alternately with <i>044</i> in the timer display.	The overheating protection mechanism has been activated. <ul style="list-style-type: none"> ■ See “Safety features – Overheating protection”.

Problem solving guide

Problem	Cause and remedy
<i>Err</i> will flash alternately with 047, 048 or 049 in the timer display.	The fan is blocked or defective. <ul style="list-style-type: none">■ Make sure it has not been blocked by an object.■ Remove the obstruction.■ If this fault message continues to appear in the display, contact the Customer Service Department.
A message not listed in this table is appearing in the timer display.	There is an electronic module fault. <ul style="list-style-type: none">■ Interrupt the power supply to the SmartLine element for approx. 1 minute.■ If the problem persists after power has been restored, please contact the Customer Service Department.

Unexpected behaviour

Problem	Cause and remedy
The power level selected is flashing.	<p>There is no pan on the cooking zone, or the pan is unsuitable.</p> <ul style="list-style-type: none"> ■ Use suitable pans (see “Induction - Pans”).
The sensor controls show increased sensitivity or fail to react.	<p>The sensitivity level of the sensor controls has changed.</p> <ul style="list-style-type: none"> ■ Make sure that there is no direct light (from the sun or from an artificial source) falling onto the SmartLine element. The area surrounding the SmartLine element must not be too dark. ■ Take any pans off the SmartLine element and wipe away any food deposits. Ensure that there is nothing covering the entire SmartLine element unit or sensor controls. ■ Interrupt the power supply to the SmartLine element for approx. 1 minute. ■ If the problem persists after power has been restored, please contact Miele Service.
Power level 9 is automatically reduced if you also set power level 9 for the connected cooking zone.	<p>Operating both zones at power level 9 exceeds the permitted maximum power for the two zones.</p> <ul style="list-style-type: none"> ■ Use a different cooking zone.
A cooking zone switches off automatically.	<p>It has been operated for too long.</p> <ul style="list-style-type: none"> ■ You can use the cooking zone again by switching it back on (see “Safety switch-off”).
The cooking zone is not working in the usual way on the power setting selected.	<p>The overheating protection mechanism has been activated.</p> <ul style="list-style-type: none"> ■ See “Safety features”.
A cooking zone or the whole hob switches off automatically.	<p>The overheating protection mechanism has been activated.</p> <ul style="list-style-type: none"> ■ See “Safety features”.
The Booster has deactivated early automatically.	<p>The overheating protection mechanism has been activated.</p> <ul style="list-style-type: none"> ■ See “Safety features”.

Problem solving guide

Unsatisfactory results

Problem	Cause and remedy
The food in the pan does not heat up when the Auto heat-up function is switched on.	A large amount of food is being heated up. ■ Start cooking at the highest power level and then turn down to a lower one manually later on.
	The pan is not conducting heat properly. ■ Use a different pot or pan which conducts heat properly.

General problems or technical faults

Problem	Cause and remedy
The SmartLine element cannot be switched on.	There is no power to the SmartLine element. ■ Check whether the mains fuse has tripped. Contact an electrician or Miele Service (for the minimum fuse rating, see data plate).
	There may be a technical fault. ■ Disconnect the SmartLine element from the mains electricity supply for approx. 1 minute by – tripping the relevant mains fuse or screwing the fuse out completely, or – switching off the residual current protection device. ■ If, after resetting the trip switch in the mains fuse box or the residual current protection device, the SmartLine element will still not switch on, contact a qualified electrician or Miele Service.
A smell and vapours are given off when the new appliance is being used.	The metal components have a protective coating. When the appliance is used for the first time, this causes a smell and possibly also vapour. The material from which the induction coils are made also gives off a smell in the first few hours of operation. With each subsequent use, the odour is reduced until it disappears completely. The smell and any vapours given off do not indicate a faulty connection or appliance and they are not hazardous to health.

Problem solving guide

Problem	Cause and remedy
An operating noise can be heard after the SmartLine element has been switched off.	The cooling fan runs until the SmartLine element has cooled down and then switches off automatically.

Optional accessories

Miele offer a comprehensive range of useful accessories as well as cleaning and conditioning products for your Miele appliances.

These products can be ordered through the Miele Webshop.

They can also be ordered from Miele (see end of this booklet for contact details) or from your Miele dealer.

Ceramic and stainless steel hob cleaner 250 ml



Removes heavy soiling, limescale deposits and aluminium residues

Microfibre cloth

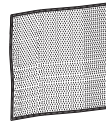

Removes finger marks and light soiling

Contact in the event of a fault

In the event of any faults which you cannot remedy yourself, please contact your Miele dealer or the Miele Customer Service Department.

You can book a Miele Customer Service Department call-out online at www.miele.com/service.

Contact information for the Miele Customer Service Department can be found at the end of this document.

Please quote the model identifier and serial number of your appliance (Fabr./SN/ Nr.) when contacting the Miele Customer Service Department. This information can be found on the data plate.

Please note that telephone calls may be monitored and recorded for training purposes and that a call-out charge will be applied to service visits where the problem could have been resolved as described in this booklet.

Data plate

Stick the extra data plate supplied with the appliance here. Make sure that the model number matches the one specified on the back cover of this document.

Warranty

For information on the appliance warranty specific to your country please contact Miele. See back cover for address.

In the UK, your appliance warranty is valid for 2 years from the date of purchase. However, you must activate your cover by calling 0330 160 6640 or registering online at www.miele.co.uk.

Installation

Safety instructions for installation



Damage risk from incorrect installation.

Incorrect installation can cause damage to the SmartLine element.

The SmartLine element must only be installed by a qualified person.



Risk of electric shock!

Incorrect connection to the mains supply may result in an electric shock.

The SmartLine element must be connected to the electrical supply by a qualified person only.



Damage from falling objects.

Take care not to damage the SmartLine element when fitting wall units or a cooker hood above it.

Fit the wall units and the cooker hood before the SmartLine element.

- ▶ The veneer or laminate coatings of worktops (or adjacent kitchen units) must be treated with 100 °C heat-resistant adhesive which will not dissolve or distort. Any backmoulds must be of heat-resistant material.
- ▶ The SmartLine element must not be installed over a fridge, fridge-freezer, freezer, dishwasher, washing machine, washer-dryer or tumble dryer.
- ▶ This SmartLine element must not be installed above ovens or cookers unless these have a built-in cooling down fan.
- ▶ After installation, the mains connection cable of the SmartLine element must not come into contact with any moving kitchen component (e.g. a drawer) or be subject to mechanical loads which could damage it.
- ▶ Observe carefully the safety clearances listed on the following pages.

Safety distances

Safety distance above the SmartLine element

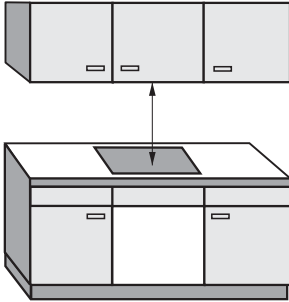

The safety distance specified by the manufacturer of the cooker hood must be maintained between the SmartLine element and the cooker hood above it.

If combustible objects are installed above the SmartLine element (e.g. cabinets, utensil rail, etc.), a minimum safety distance of 500 mm must be maintained.

When two or more SmartLine elements which have different safety distances are installed together below a cooker hood, you should observe the greatest specified safety distance.

Installation

Safety distances to the sides and back of the appliance

The SmartLine element should preferably be installed with plenty of space on the right and left.

The minimum distance ① specified below must be observed between the rear of the SmartLine element and a tall unit or room wall.

The minimum distance ②, ③ specified below must be adhered to between one side of the SmartLine element (right or left) and a tall unit or room wall. A minimum distance of 300 mm must be observed on the opposite side.

① Minimum distance between the **back** of the worktop cut-out and the rear edge of the worktop: 50 mm

② Minimum distance on the **right** side between the worktop cut-out and the closest adjacent piece of furniture (e.g. tall unit) or a room wall: 50 mm.

③ Minimum distance on the **left** side between the worktop cut-out and the closest adjacent piece of furniture (e.g. tall unit) or a room wall: 50 mm.

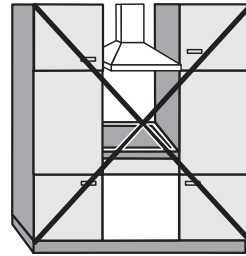

Not allowed

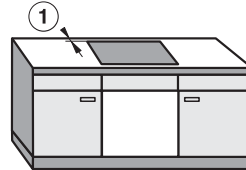
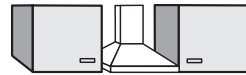

Highly recommended



Not recommended



Not recommended

Minimum safety distance underneath the SmartLine element

To ensure proper ventilation of the SmartLine element, a minimum safety distance is required between the element and an oven, interim shelf or drawer.

The minimum safety distance from the lower edge of the SmartLine element to

- Upper edge of oven: 15 mm
- Upper edge of interim shelf: 15 mm
- Upper edge of drawer: 5 mm
- Base of drawer: 75 mm

Intermediate shelf

It is not necessary to fit an interim shelf underneath the SmartLine element but one may be fitted if you wish.

Leave a gap of 10 mm at the back of the shelf to accommodate the mains connection cable. We recommend a gap at the front of the SmartLine element of 20 mm to ensure good ventilation.

Installation

Safety distance when installing the appliance near a wall with additional niche cladding

If a niche cladding is installed, a minimum safety distance must be maintained between the worktop cut-out and the cladding, since high temperatures can damage these materials.

If the niche cladding is made from a combustible material (e.g. wood) a minimum safety distance ⑤ of 50 mm must be maintained between the worktop cut-out and the cladding.

If the niche cladding is made from a non-combustible material (e.g. metal, natural stone, ceramic tiles) the minimum safety distance ⑤ between the worktop cut-out and the cladding will be 50 mm less the thickness of the cladding.

Example: 15 mm niche cladding

50 mm - 15 mm = minimum safety distance of 35 mm

Flush-fit installation

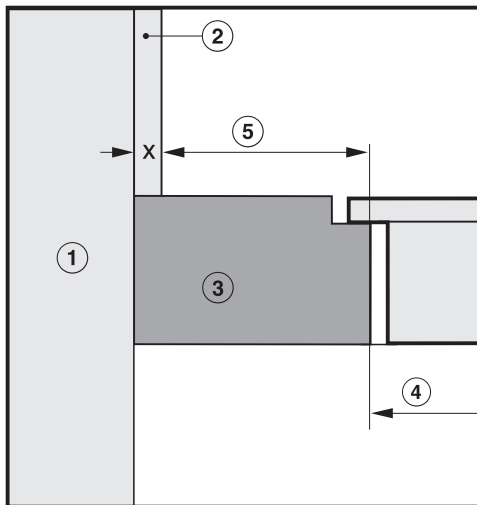

Onset installation

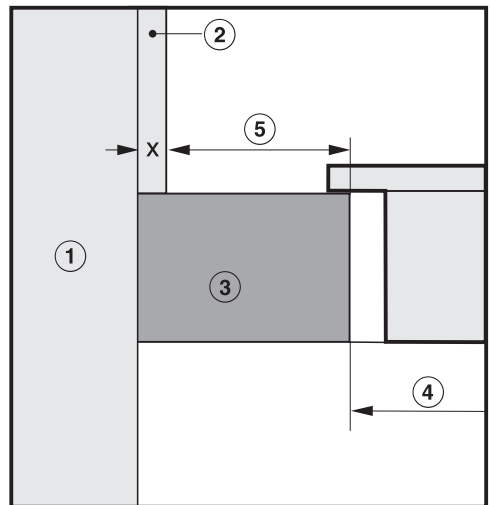

- ① Masonry
- ② Niche cladding dimension x = thickness of the niche cladding material
- ③ Worktop
- ④ Worktop cut-out
- ⑤ Minimum distance to
combustible materials 50 mm
non-combustible materials 50 mm - dimension x

Installation notes – surface-mounted

Sealing between the SmartLine Element and the worktop

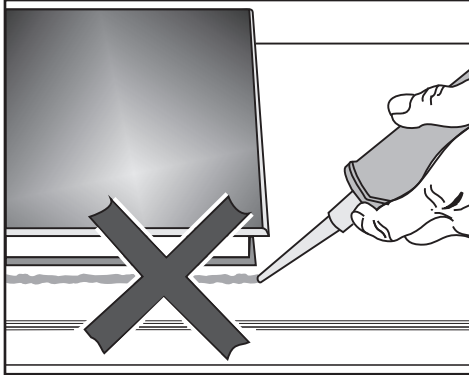

The SmartLine element and worktop may be damaged if the element needs to be removed after it has been sealed with a sealant.

Do not use any sealant between the SmartLine element and the worktop. The seal under the edge of the top part of the appliance provides a sufficient seal for the worktop.

Tiled worktop

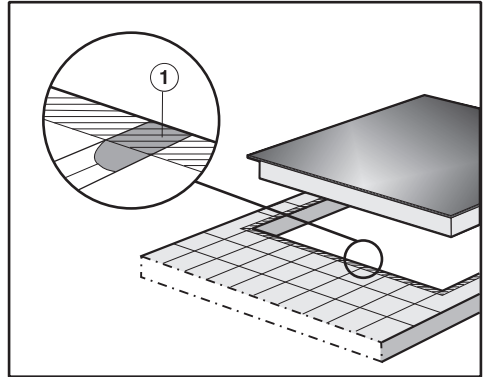

Grout lines ① and the hatched area underneath the SmartLine element frame must be smooth and even. If they are not, the SmartLine element will not sit flush with the worktop and the sealing strip underneath the top part of the appliance will not provide a good seal between the appliance and the worktop.

Sealing strip

Dismantling the SmartLine element for service purposes may damage the sealing strip underneath the edge of the SmartLine element.

Always replace the sealing strip before reinstalling the SmartLine element.

Installation

Installing several SmartLine elements

The gaps between the individual SmartLine elements are sealed with a silicone sealant that is heat-resistant to at least 160 °C. With flush-fit installation, the gap between the SmartLine element(s) and the worktop must also be sealed with a silicone sealant that is heat-resistant to at least 160 °C.

After installation, the SmartLine elements must be easily accessible from below, so that the bottom half of the casing can be removed for maintenance. If the SmartLine elements are not accessible from below, the sealant must be removed so that they can be removed.

Combination with a downdraft extractor





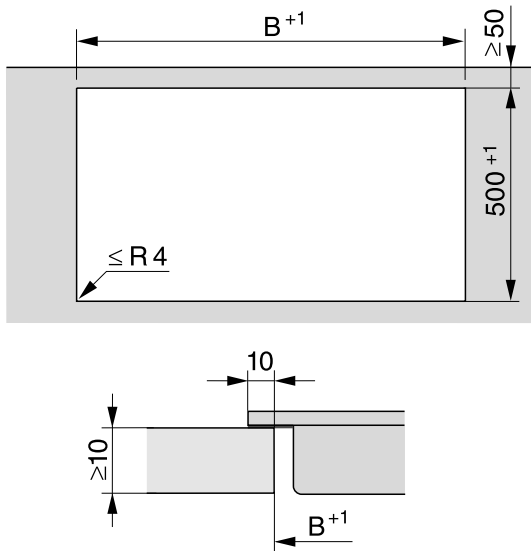

If the SmartLine element is installed in combination with a downdraft extractor, the latter must be installed first.

Worktop cutout – surface-mounted











Installation

Installation with a countertop extractor

Combination examples	Number x width [mm]		Dimension B [mm]
	Cooking elements	Countertop extractor	
	1 x 378	1 x 120	481
	2 x 378	1 x 120	862
	1 x 378 1 x 620	2 x 120	1226
	3 x 378	2 x 120	1365
	2 x 378 1 x 620	2 x 120	1607
	4 x 378	2 x 120	1746
	1 x 620	2 x 120	845

Installation without a countertop extractor

Combination examples	Number x width [mm] Cooking elements	Dimension B [mm]
	1 x 378	359
	2 x 378	740
	1 x 378 1 x 620	982
	3 x 378	1121
	2 x 378 1 x 620	1363
	4 x 378	1502
	2 x 378 1 x 800	1554
	2 x 378 1 x 936	1680

Installation

Spacer bars – surface-mounted

If you are installing several appliances, you must fit spacer bars between them.

The clips supplied with the spacer bars are only required for installing a CSDA 700x FL.

Installing 3 elements and 2 spacer bars

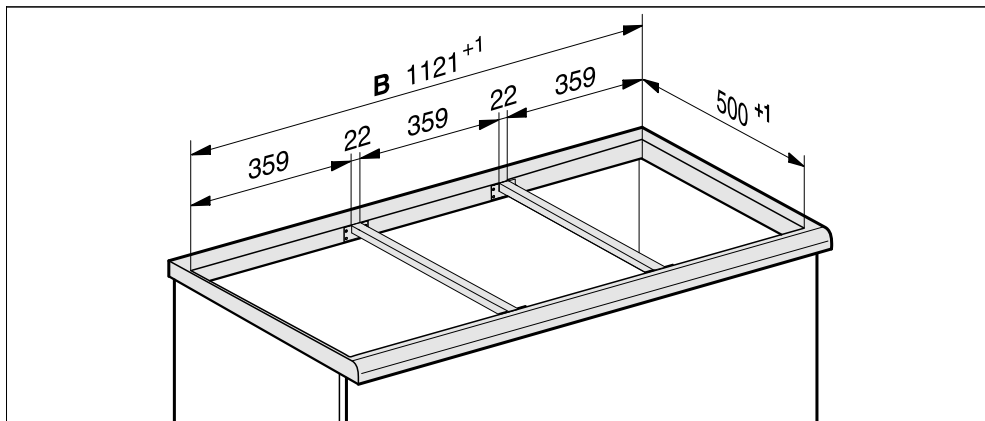

Installation dimensions – Surface-mounted

All dimensions are given in mm.

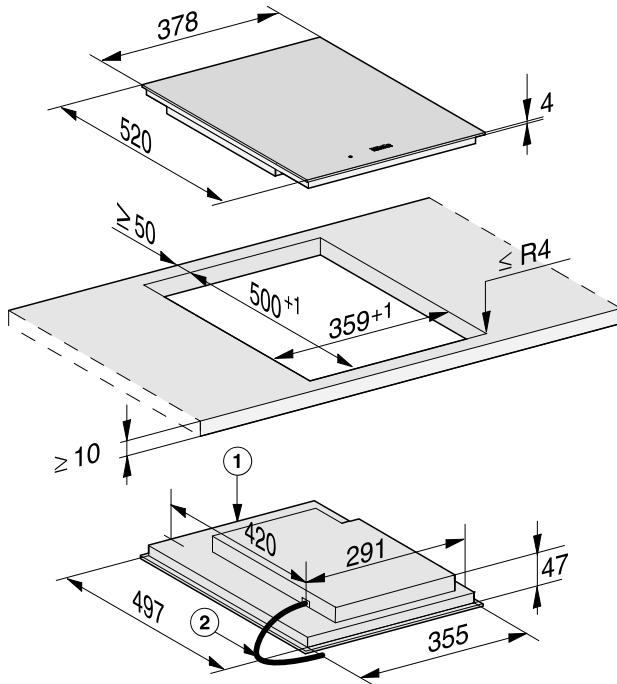

① Front

② Mains connection cable, L = 2000 mm

Installation

Installation – surface-mounted

Preparing the worktop

- Create the worktop cutout. Remember to maintain the minimum safety distances (see “Installation – Safety distances”).
- Seal any cut surfaces on **wooden worktops** with a special varnish, silicone sealant or resin to prevent the wood from swelling as a result of moisture ingress. The sealant must be heat-resistant.

Make sure that the sealant does not come into contact with the top of the worktop.

Fitting the spacer bars

Use the middle screw holes if one of the following SmartLine elements is installed to the right or left of the spacer bar: CS 7611, CS 7641, CS 7101(-1), CS 7102(-1)

Wooden worktops

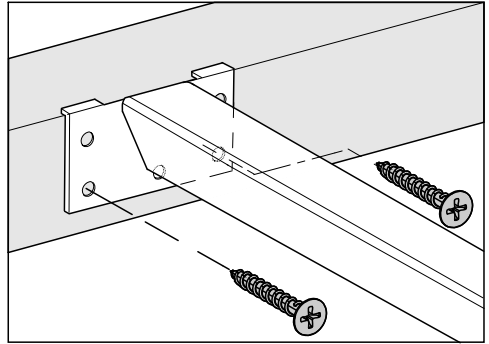

- Position the spacer bars flush onto the upper edge of the cutout.
- Secure the spacer bars with the 3.5 x 25 mm wood screws supplied.

Natural stone worktops

You will need heavy-duty double-sided tape (not supplied) to secure the spacer bars.

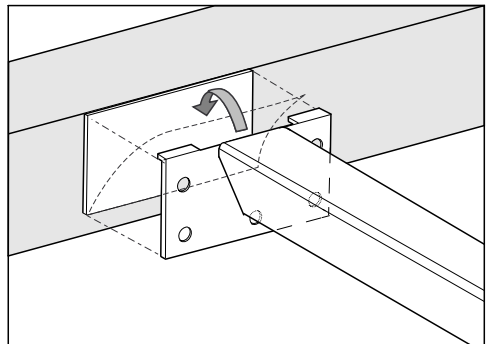

- Stick the tape along the top edge of the worktop cutout.
- Position the spacer bars flush onto the upper edge of the cutout.
- Press the spacer bars firmly into place.

Installing the SmartLine element

- Stick the supplied sealing strip under the edge of the SmartLine element. Do not apply the sealing strip under tension.
- Feed the mains connection cable down through the worktop cutout.
- Position the SmartLine element in the worktop cutout. Ensure that:
 - The seal of the appliance sits flush with the worktop on all sides to ensure an effective seal all round.
 - All gap widths are uniform.
- If the seal does not meet the worktop correctly on the corners, carefully scribe the corner radii ($\leq R4$) with a jigsaw.

Do not use any additional sealant (e.g. silicone) on the SmartLine element.

- Connect the SmartLine element to the mains electricity supply.
- If required, connect the SmartLine element to the gas supply (see “Installation – Gas connection”).
- Check that the SmartLine element works.
- Seal the gaps between the individual elements with a silicone sealant that is heat-resistant to at least 160 °C.

Unsuitable sealant can damage natural stone.

For natural stone worktops and natural stone tiles, only use silicone sealant that is specially formulated for natural stone. Follow the manufacturer's instructions.

Installation

Installation notes – flush-fit

Flush-fit installation is only possible in natural stone (granite, marble), solid wood and tiled worktops. For installation in worktops made of other materials, please consult the relevant manufacturer as to whether their worktops are suitable for flush-fit installation.

The internal width of the base unit underneath the appliance must be at least as wide as the inner worktop cutout (see “Installation – Building-in dimensions – flush-fit”), so that the SmartLine element is easily accessible from underneath after installation and the bottom half of the casing can be removed for maintenance. If the element is not freely accessible from below after installation, the sealant must be removed so that the element can be removed.

Natural stone worktops

The SmartLine element is set directly in the cutout.

Solid wood worktops, tiled worktops, glass worktops

The SmartLine element is set on a wooden frame inside the cutout. The frame must be provided on site, and is not supplied with the appliance.

Sealing strip

Dismantling the SmartLine element for service purposes may damage the sealing strip underneath the edge of the SmartLine element.

Always replace the sealing strip before reinstalling the SmartLine element.

Installing several SmartLine elements

The gaps between the individual SmartLine elements are sealed with a silicone sealant that is heat-resistant to at least 160 °C. With flush-fit installation, the gap between the SmartLine element(s) and the worktop must also be sealed with a silicone sealant that is heat-resistant to at least 160 °C.

After installation, the SmartLine elements must be easily accessible from below, so that the bottom half of the casing can be removed for maintenance. If the SmartLine elements are not accessible from below, the sealant must be removed so that they can be removed.

Combination with a downdraft extractor

If the SmartLine element is installed in combination with a downdraft extractor, the latter must be installed first.

Installation

Worktop cutout – flush-fit

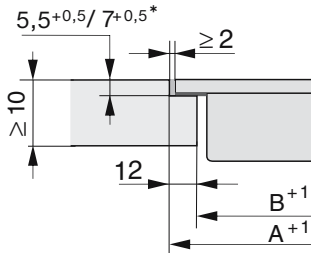
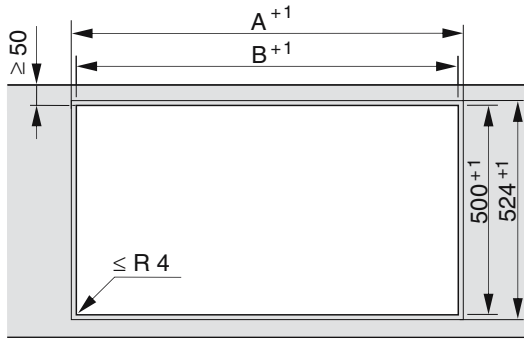



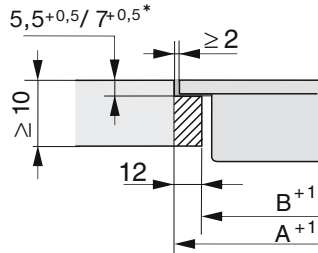



Natural stone worktop

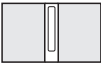

Wooden worktop







* $7^{+0,5}$ mm with CS 7611 FL

Installation with a countertop extractor

Combination examples	Number x width [mm]		Dimension A [mm]	Dimension B [mm]
	Cooking elements	Countertop extractor		
	1 x 378	1 x 120	505	481
	2 x 378	1 x 120	886	862
	1 x 378 1 x 620	2 x 120	1250	1226
	3 x 378	2 x 120	1389	1365
	2 x 378 1 x 620	2 x 120	1631	1607
	4 x 378	2 x 120	1770	1746
	1 x 620	2 x 120	869	845

Installation

Installation without a countertop extractor

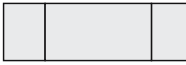
Combination ex- amples	Number x width [mm] Cooking elements	Dimension A [mm]	Dimension B [mm]
	1 x 378	383	359
	2 x 378	764	740
	1 x 378 1 x 620	1006	982
	3 x 378	1145	1121
	2 x 378 1 x 620	1387	1363
	4 x 378	1526	1502
	2 x 378 1 x 800	1567	1543
	2 x 378 1 x 936	1703	1679

Spacer bars – flush-fit

If you are installing several appliances, you must fit spacer bars between them.

The clips supplied with the spacer bars are only required for installing a CSDA 700x FL.

Installing 3 elements and 2 spacer bars

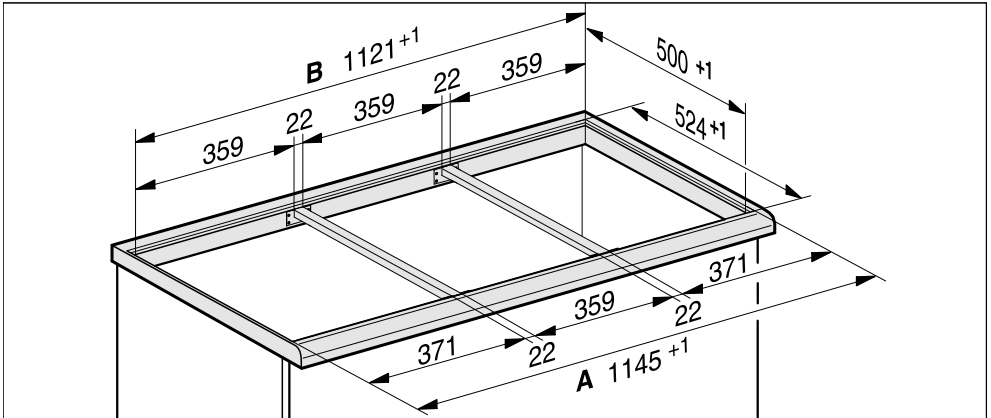

Installation

Installation dimensions – Flush-fit

All dimensions are given in mm.

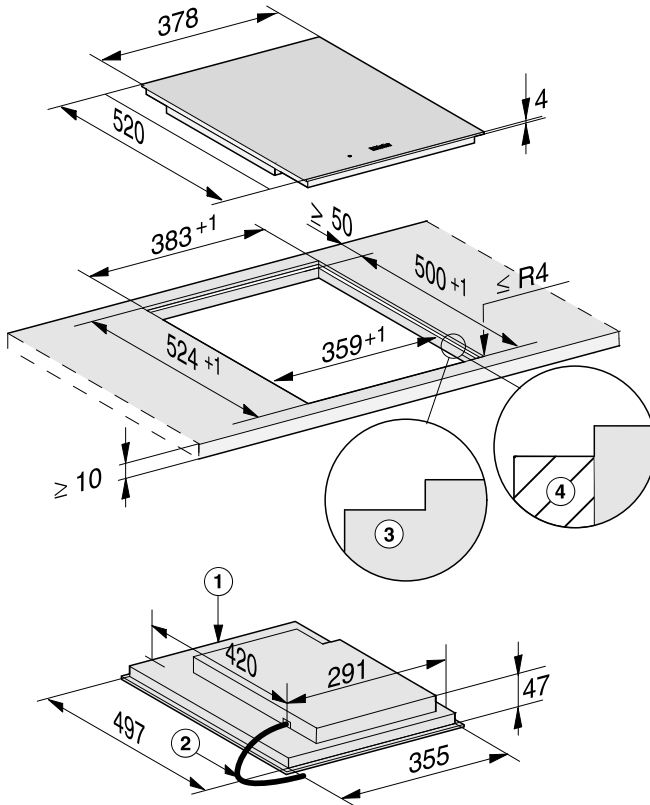

- ① Front
- ② Mains connection cable, L = 2000 mm
- ③ Stepped cutout (for detailed illustrations, see “Installation – Worktop cutout – flush-fit”)
- ④ 12 mm wooden frame (not supplied, for detailed illustrations, see “Installation – Worktop cutout – flush-fit”)

Installation – flush-fit

Preparing the worktop

- Create the worktop cutout. Remember to maintain the minimum safety distances (see “Installation – Safety distances”).
- Seal any cut surfaces on **wooden worktops** with a special varnish, silicone sealant or resin to prevent the wood from swelling as a result of moisture ingress. The sealant must be heat-resistant.

Make sure that the sealant does not come into contact with the top of the worktop.

- For wooden worktops, secure the wooden frame 5.5 mm below the upper edge of the worktop. For CS 7611 FL, the wooden frame must be secured 7 mm under the upper edge of the worktop.

Fitting the spacer bars

Use the middle screw holes if one of the following SmartLine elements is installed to the right or left of the spacer bar: CS 7611, CS 7641, CS 7101(-1), CS 7102(-1)

Wooden worktops

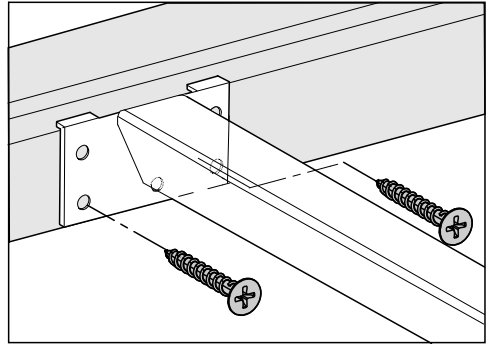

- Position the spacer bars flush onto the lower step of the stepped cutout.
- Secure the spacer bars with the 3.5 x 25 mm wood screws supplied.

Natural stone worktops

You will need heavy-duty double-sided tape (not supplied) to secure the spacer bars.

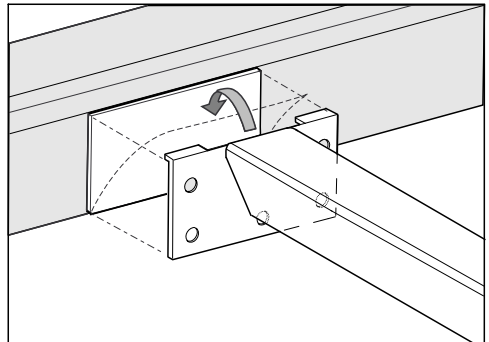

- Stick the tape onto the lower step of the stepped cutout.
- Position the spacer bars flush onto the lower step of the stepped cutout.
- Press the spacer bars firmly into place.

Installation

Installing the SmartLine element

- Stick the supplied sealing strip under the edge of the SmartLine element. Do not apply the sealing strip under tension.
- Feed the mains connection cable down through the worktop cutout.
- Position the SmartLine element in the worktop cutout. Ensure that:
 - The seal of the appliance sits flush with the worktop on all sides to ensure an effective seal all round.
 - All gap widths are uniform.
- Connect the SmartLine element to the mains electricity supply.
- If required, connect the SmartLine element to the gas supply (see “Installation – Gas connection”).
- Check that the SmartLine element works.
- Seal the gaps between the individual elements and between the elements and the worktop with a silicone sealant that is heat-resistant to at least 160 °C.

Unsuitable sealant can damage natural stone.

For natural stone worktops and natural stone tiles, only use silicone sealant that is specially formulated for natural stone. Follow the manufacturer’s instructions.

Electrical connection

 Risk of damage from incorrect connection.

Unauthorised installation, maintenance and repairs can cause considerable danger for the user.

Miele cannot be held liable for damage or injury caused by unauthorised installation, maintenance or repair work, or by an inadequate or faulty on-site earthing system (e.g. electric shock).

This SmartLine element must be connected to the electrical supply by a qualified electrician.

The electrician must be familiar with and comply with the national regulations and any additional regulations of the local electricity provider (e.g. BS 7671 in the UK).

After installation, ensure that all electrical components are shielded and cannot be accessed by users.

Total power rating

See data plate

Connection data

The connection data is quoted on the data plate. Please ensure these match the household mains supply.

Residual current device

For extra safety, it is advisable to protect the SmartLine element with a suitable residual current device (RCD) with a trip range of 30 mA.

Disconnecting devices

It must be possible to disconnect the SmartLine element from the mains at all poles using disconnecting devices! A contact distance of at least 3 mm must be observed in the switched-off state! The disconnecting devices are overcurrent protection devices and residual current protection devices.

Installation

Disconnecting from the mains



Risk of electric shock.

There is a risk of electric shock if the appliance is connected to the mains supply during repair or service work. After disconnection, ensure the appliance cannot be switched back on by mistake.

To disconnect the appliance from the mains power supply, do one of the following depending on installation:

Safety fuses

- Completely remove fuses.

Automatic circuit breakers

- Press the (red) test button until the middle (black) button springs out.

Built-in circuit breakers

- Circuit breakers at least type B or C:
Switch the lever from 1 (on) to 0 (off).

Residual current device (RCD)

- Switch the main switch from 1 (on) to 0 (off) or press the test button.

Replacing the mains connection cable



Risk of electric shock.

Incorrect connection to the power supply may result in an electric shock.

The mains cable must only be replaced by a qualified electrician.

When replacing the mains cable only use cable type H 05 V2V2-F with a suitable cross section. A suitable connection cable is available to order from Miele.

The following data sheets apply to the models described in this operating instruction manual.

Information for domestic electric hobs

In acc. with regulation (EU) No. 66/2014

MIELE	
Model name/identifier	CS 7612
Number of cooking zones and/or areas	2
For circular cooking zones: diameter of useful surface area/cooking zone For non-circular cooking zones or areas: length and width of useful surface area per electric cooking zone or area	1. = 230x390 mm 2. = 3. = 4. = 5. = 6. =
Energy consumption per cooking zone or area calculated per kg ($EC_{\text{electric cooking}}$)	1. = 184,6 Wh/kg
Energy consumption for the hob calculated per kg ($EC_{\text{electric hob}}$)	184,6 Wh/kg

United Kingdom

Miele Co. Ltd., Fairacres, Marcham Road, Abingdon, Oxon, OX14 1TW

Tel: 0330 160 6600, Internet: www.miele.co.uk/service, E-mail: info@miele.co.uk

Australia

Miele Australia Pty. Ltd.
ACN 005 635 398
ABN 96 005 635 398
1 Gilbert Park Drive
Knoxfield, VIC 3180
Tel: 1300 464 353
Internet: www.miele.com.au

China Mainland

Miele Electrical Appliances Co., Ltd.
1-3 Floor, No. 82 Shi Men Yi Road
Jing' an District
200040 Shanghai, PRC
Tel: +86 21 6157 3500
Fax: +86 21 6157 3511
E-mail: info@miele.cn
Internet: www.miele.cn

Hong Kong, China

Miele (Hong Kong) Ltd.
41/F - 4101, Manhattan Place
23 Wang Tai Road
Kowloon Bay, Hong Kong
Tel: (852) 2610 1025
Fax: (852) 3579 1404
Email:
customerservices@miele.com.hk
Website: www.miele.hk

India

Miele India Pvt. Ltd.
1st Floor, Copia Corporate Suites,
Commercial Plot 9,
Mathura Road, Jasola,
New Delhi - 110025
E-mail: customercare@miele.in
Website: www.miele.in

Ireland

Miele Ireland Ltd.
2024 Bianconi Avenue
Citywest Business Campus
Dublin 24
Tel: (01) 461 07 10
Fax: (01) 461 07 97
E-Mail: info@miele.ie
Internet: www.miele.ie

Malaysia

Miele Sdn Bhd
Suite 12-2, Level 12
Menara Sapura Kencana
Petroleum
Solaris Dutamas No. 1
Jalan Dutamas 1
50480 Kuala Lumpur, Malaysia
Phone: +603-6209-0288
Fax: +603-6205-3768

New Zealand

Miele New Zealand Limited
IRD 98 463 631
8 College Hill
Freemans Bay, Auckland 1011
New Zealand
Tel: 0800 464 353
Internet: www.miele.co.nz

Singapore

Miele Pte. Ltd.
29 Media Circle
#11-04 ALICE@Mediapolis
Singapore 138565
sTel: +65 6735 1191
Fax: +65 6735 1161
E-Mail: info@miele.com.sg
Internet: www.miele.sg

South Africa

Miele (Pty) Ltd.
63 Peter Place
Bryanston 2194
P.O. Box 69434
Bryanston 2021
Tel: (011) 875 9000
Fax: (011) 875 9035
E-mail: info@miele.co.za
Internet: www.miele.co.za

Thailand

Miele Appliances Ltd.
BHIRAJ TOWER at EmQuartier
43rd Floor Unit 4301-4303
689 Sukhumvit Road
North Klongton Sub-District
Vadhana District
Bangkok 10110, Thailand

United Arab Emirates

Miele Appliances Ltd.
Showroom 1
Eiffel 1 Building
Sheikh Zayed Road, Umm Al Sheif
P.O. Box 114782 - Dubai
Tel. +971 4 3044 999
Fax. +971 4 3418 852
800-MIELE (64353)
E-Mail: info@miele.ae
Website: www.miele.ae

Manufacturer: Miele & Cie. KG, Carl-Miele-Straße 29, 33332 Gütersloh, Germany

CS 7612

en-GB

M.-Nr. 10 758 371 / 04