

Operating and installation instructions Rangehood



To prevent the risk of accidents or damage to the appliance, it is **essential** to read these instructions before it is installed and used for the first time.

Contents

| | |
|--|----|
| Warning and Safety instructions | 4 |
| Caring for the environment | 13 |
| Guide to the rangehood | 14 |
| Description of the functions | 16 |
| Before using for the first time | 17 |
| Selecting extraction mode or recirculation mode..... | 17 |
| Setting up Miele@home | 17 |
| Connecting via the App..... | 18 |
| Connecting via WPS | 19 |
| Signing out of Wi-Fi (reset to factory settings)..... | 20 |
| Setting up Con@ctivity | 21 |
| Con@ctivity via the home Wi-Fi network (Con@ctivity 3.0)..... | 22 |
| Con@ctivity via a direct Wi-Fi connection (Con@ctivity 3.0)..... | 22 |
| Operation (automatic mode) | 24 |
| Cooking with Con@ctivity (automatic mode) | 24 |
| Cooking process | 25 |
| Leaving automatic mode temporarily..... | 26 |
| Returning to automatic mode..... | 26 |
| Operation (manual mode) | 27 |
| Cooking without Con@ctivity (manual mode) | 27 |
| Switching the fan on..... | 27 |
| Selecting a power level | 27 |
| Selecting the run-on time | 27 |
| Switching the fan off | 27 |
| Dimming/switching the cooktop lighting on/off | 28 |
| Power management | 28 |
| Safety switch-off | 29 |
| Operation (automatic and manual modes) | 30 |
| Operating hours counter | 30 |
| Altering the grease filter operating hours counter | 30 |
| Altering or deactivating the charcoal filter operating hours counter | 31 |
| Reading the filter operating hours counter..... | 31 |
| Energy saving tips | 32 |
| Cleaning and care | 33 |
| Housing | 33 |
| Grease filters and edge extraction panel..... | 34 |

| | |
|---|----|
| NoSmell active charcoal filters | 37 |
| Resetting the charcoal filter operating hours counter | 38 |
| Disposing of the charcoal filters | 38 |
| Installation | 39 |
| Before installation..... | 39 |
| Installation instructions..... | 39 |
| Installation recommendations | 39 |
| Installation materials..... | 40 |
| Appliance dimensions | 41 |
| Safety distance (S) | 43 |
| Uneven installation surfaces | 44 |
| Connection for air extraction | 45 |
| Silencer..... | 46 |
| Electrical connection | 47 |
| Service | 48 |
| Contact in case of fault | 48 |
| Position of the data plate | 48 |
| Warranty | 48 |
| Technical data | 49 |
| Optional accessory for recirculation mode | 49 |

Warning and Safety instructions

This rangehood complies with all relevant local and national safety requirements. However, inappropriate use can lead to personal injury and damage to property.

Read the operating and installation instructions carefully before using the rangehood. They contain important information on the safety, installation, use and maintenance of the appliance. This prevents both personal injury and damage to the rangehood.

In accordance with standard IEC 60335-1, Miele expressly and strongly advises that you read and follow the instructions in “Installation” and in the “Warning and Safety instructions”.

Miele cannot be held liable for injury or damage caused by non-compliance with these instructions.

Keep these instructions in a safe place and pass them on to any future owner.

Correct application

▶ This rangehood is designed for domestic use and for use in similar environments by guests in hotel or motel rooms, bed & breakfasts and other typical living quarters. This does not include common/shared facilities or commercial facilities within hotels, motels or bed & breakfasts.

▶ The appliance is not suitable for outdoor use.

▶ It must only be used to extract vapours and remove odours from cooking.

Any other usage is at the owner's risk. Miele cannot be held liable for damage resulting from incorrect or improper use or operation.

▶ The rangehood cannot be used to ventilate the room in which it is installed in recirculation mode above a gas cooktop. Please seek the advice of a qualified gas fitter for more information if necessary.

Warning and Safety instructions

▶ This appliance is not intended for use by persons (including children) with reduced physical, sensory or mental capabilities, or lack of experience and knowledge, unless they have been given supervision or instruction concerning its use by a person responsible for their safety, and are able to recognise the dangers of misuse.

Safety with children

▶ Young children must not be allowed to use the rangehood.

▶ Older children may only use the rangehood if its operation has been clearly explained to them and they are able to use it safely. They must be able to understand and recognise the possible dangers caused by incorrect operation.

▶ Cleaning work may only be carried out by older children under the supervision of an adult.

▶ Children should be supervised near the appliance. Ensure that they do not play with the appliance.

▶ The cooktop lighting is very intense.

Ensure, in particular, that babies/small children do not look directly at the light.

▶ Danger of suffocation! Whilst playing, children may become entangled in packaging material (such as plastic wrapping) or pull it over their head with the risk of suffocation. Keep packaging material away from children.

Warning and Safety instructions

Technical safety

- ▶ Unauthorised installation, maintenance and repairs (including removal of any cover) can cause considerable danger for the user. Installation, maintenance and repairs must only be carried out by a Miele authorised technician.
- ▶ A damaged appliance can be dangerous. Check it for visible signs of damage. Do not use a damaged appliance.
- ▶ The electrical safety of this appliance can only be guaranteed when continuity is complete between it and an effective earthing system. It is most important that this basic safety requirement is present and tested regularly and, where there is any doubt, the household wiring system should be inspected by a qualified electrician.
- ▶ Reliable and safe operation of this rangehood can only be assured if it has been connected to the mains electricity supply.
- ▶ The connection data (voltage and frequency) on the data plate of the rangehood must match the mains electricity supply in order to avoid the risk of damage to the rangehood.
Compare this before connecting the appliance to the mains electricity. If in doubt, consult a qualified electrician.
- ▶ Do not connect the appliance to the mains electricity supply by a multi-socket unit or an extension lead. Extension leads are a fire hazard and do not guarantee the required safety of the appliance.
- ▶ EXT/EXTA model rangehoods are connected to their external motor using a special connection cable and plug connectors. These appliances may only be combined with a Miele external motor.

Warning and Safety instructions

▶ For safety reasons, this appliance may only be used after it has been built in.

▶ This rangehood must not be installed and operated in mobile installations (e.g. on a ship).

▶ Tampering with electrical connections or components and mechanical parts is highly dangerous to the user and can cause operational faults.

Only open the housing as described in the instructions given in the installation sheet and in the “Cleaning and care” section of this booklet. Under no circumstances should any other parts of the housing be opened.

▶ The manufacturer's warranty will be invalidated if the appliance is not repaired by a Miele authorised service technician.

▶ Faulty components must only be replaced by genuine Miele spare parts. The manufacturer can only guarantee the safety of the appliance when Miele replacement parts are used.

▶ If the mains connection cable is damaged, it must only be replaced by a Miele authorised service technician or suitably qualified and competent electrician in order to avoid a hazard.

▶ During installation, maintenance and repair work, the appliance must be disconnected from the mains electricity supply. It is only completely isolated from the electricity supply when:

- the mains circuit breaker is switched off, or
- it is switched off at the wall socket and the plug is withdrawn from the socket. Do not pull the mains connection cable but the mains plug to disconnect your appliance from the mains electricity supply.

Warning and Safety instructions

Using at the same time as other heating appliances that depend on the air from the room

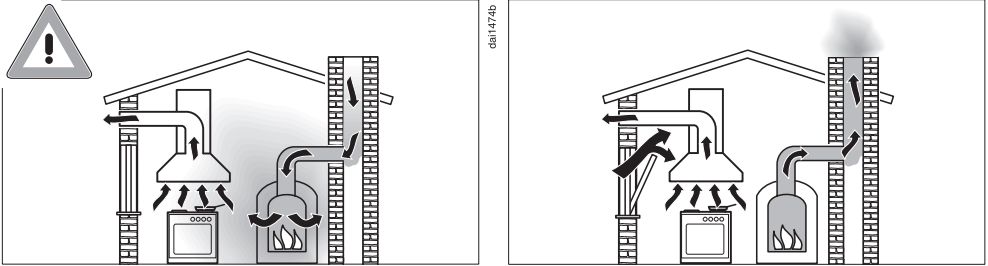

Danger of toxic fumes!

Great care should be taken when using the rangehood in the same room or the same area of the house as another heating appliance that depends on the air from the room.

Such heating appliances draw in air from the room and duct exhaust gases out through a chimney or extraction ducting. They include gas, oil, wood and coal-fired boilers and heaters, continuous flow or other water heaters, gas cooktops and ovens.

The rangehood draws in air from the kitchen and from neighbouring rooms. This applies to the following modes of operation:

- extraction mode,
- extraction mode with an external motor,
- recirculation mode with a recirculation box installed outside the room.

If there is insufficient air, an underpressure will occur. The heating appliance may be starved of oxygen. This impairs combustion. Harmful gases could be drawn from the chimney or extraction ducting back into the room.

This could have potentially fatal consequences. Risk of death!

Warning and Safety instructions

In order to ensure safe operation and to prevent gases given off by a heating appliance from being drawn back into the room, when the rangehood and the heater are both operated simultaneously, an underpressure in the room of 0.04 mbar (4 Pa) is the maximum permissible.

Sufficient ventilation can be maintained by air inlets which cannot be blocked, e.g. in windows, doors and outside wall vents. The diameter of the inlet openings must enable sufficient ventilation. A ventilation brick alone is not generally sufficient to ensure safe ventilation.

The overall ventilation condition of the dwelling must be taken into account. If in any doubt, the advice of a competent builder or, for gas, a qualified gas fitter (registered with an official gas safety body in accordance with national safety regulations) must be sought.

If the rangehood is being operated in recirculation mode, whereby the air is redirected into the room in which it is installed, the above restrictions do not apply.

Warning and Safety instructions

Correct use

▶ Open flames are a fire hazard!

Never use an open flame under the rangehood. To avoid the danger of fire, do not flambé or grill over an open flame. When switched on, the rangehood could draw flames into the filter. Kitchen grease deposits could ignite.

▶ The rangehood can become damaged when exposed to excessive heat.

- When using the rangehood over a gas cooktop, ensure that any burners in use are always covered by a pan. Switch the cooking zone off when a pan is removed, even for a short time.
- Select a pan which is suitable for the size of the burner.
- Regulate the flame so that it does not burn up the sides of the pan.
- Avoid overheating the pan (e.g. when cooking with a wok).

▶ Always switch the rangehood on when a cooking zone is in use, otherwise condensation may collect in the rangehood, which could cause corrosion.

▶ Overheated oil and fat can ignite, causing fire damage to the rangehood.

When cooking with oil or fat, chip pans and deep fat fryers etc., do not leave the pans unattended. Similarly, never leave an open grill unattended when grilling.

Warning and Safety instructions

- ▶ Do not use the rangehood without the filters in place. This way you will avoid the risk of grease and dirt getting into the appliance and hindering its smooth operation.
- ▶ The rangehood can get very hot during cooking due to heat rising from the cooktop.
Do not touch the housing or the grease filters until the rangehood has cooled down.

Correct installation

- ▶ Refer to the cooktop manufacturer's instructions as to whether a rangehood may be operated above the cooktop.
- ▶ Safety regulations prohibit the fitting of a rangehood over solid fuel stoves.
- ▶ An insufficient safety distance between the cooktop and the rangehood can result in damage to the rangehood.
The minimum safety distances between the top of the cooktop and the bottom of the rangehood given in the “Installation” section of this booklet must be observed, unless the cooktop manufacturer states that a greater safety distance is required.
If more than one cooking appliance is fitted beneath the rangehood, and they have different minimum safety distances to the rangehood, select the greater distance.
- ▶ The information provided in “Installation” must be observed when installing the rangehood.
- ▶ There may be a risk of injury due to protruding parts and sharp edges.
Wear gloves that offer protection against cuts during assembly.
- ▶ All ducting, pipework and fittings must be of non-flammable material and comply with all relevant national and local building regulations.

Warning and Safety instructions

- ▶ The appliance must not be connected to a chimney or vent flue which is in current use for exhausting fumes from appliances burning gas or other fuels. Neither should it be connected to ducting which ventilates rooms with fireplaces.
- ▶ If exhaust air is to be extracted into a chimney or ventilation duct no longer used for other purposes, seek professional advice.

Cleaning and care

- ▶ There is a risk of fire if cleaning is not carried out as described in these operating instructions.
- ▶ Do not use a steam cleaning appliance to clean this appliance. The steam could reach electrical components and cause a short circuit.
- ▶ In areas which may be subject to infestation by cockroaches or other vermin, pay particular attention to keeping the machine and its surroundings in a clean condition at all times. Any damage which may be caused by cockroaches or other vermin will not be covered by the machine warranty.

Accessories

- ▶ Use only genuine original Miele spare parts. If spare parts or accessories from other manufacturers are used, the warranty will be invalidated, and Miele cannot accept liability.

Disposal of the packing material

The transport and protective packaging has been selected from materials which are environmentally friendly for disposal, and can normally be recycled.

Recycling the packaging reduces the use of raw materials in the manufacturing process and also reduces the amount of waste in landfill sites. Ensure that any plastic wrappings, bags etc. are disposed of safely and kept out of the reach of babies and young children. Danger of suffocation.

Disposing of your old appliance

Electrical and electronic appliances often contain valuable materials. They also contain specific materials, compounds and components, which were essential for their correct function and safety. These could be hazardous to human health and to the environment if disposed of with your domestic waste or if handled incorrectly. Please do not, therefore, dispose of your old appliance with your household waste.



Please dispose of it at your local community waste collection / recycling centre for electrical and electronic appliances. You are also responsible for deleting any personal data that may be stored on the appliance prior to disposal. Please ensure that your old appliance poses no risk to children while being stored prior to disposal.

Guide to the rangehood

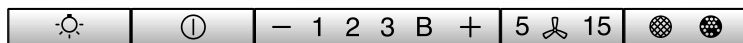
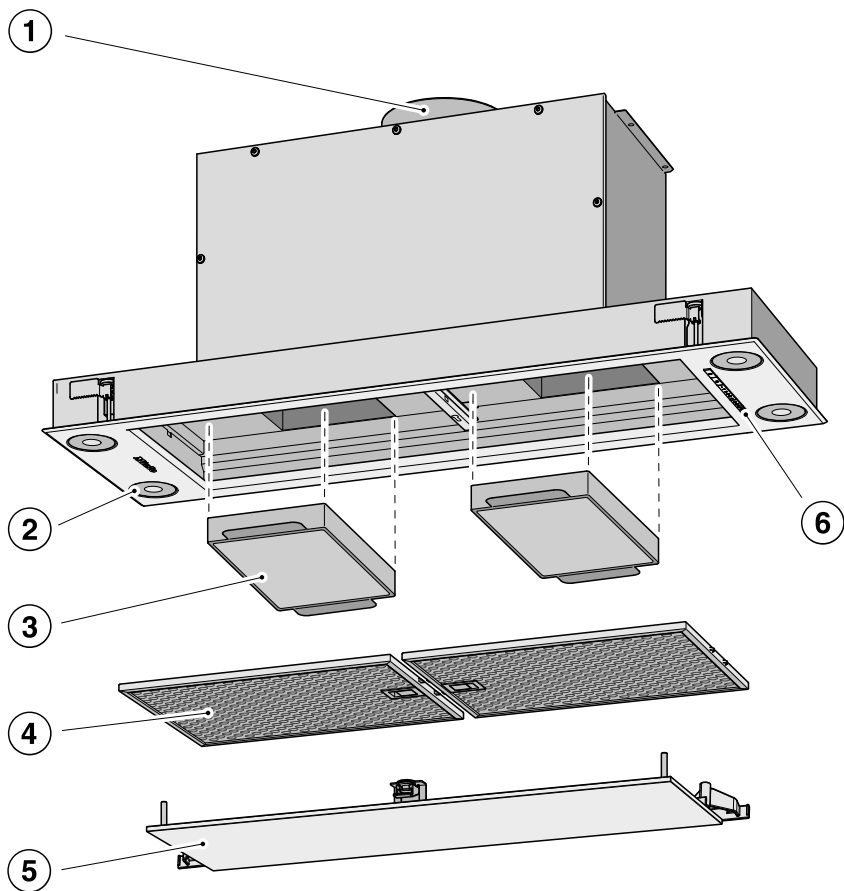

7

8

9

10

11

- ① Exhaust connection
Extraction ducting can be directed through the back of the rangehood or upwards to the ceiling.
- ② Cooktop lighting
- ③ Charcoal filter
Optional accessory for recirculation mode
DA 2668, DA 2698 only
- ④ Grease filter
DA 2668, DA 2698: x 1,
DA 2628: x 2
- ⑤ Edge extraction panel
DA 2668, DA 2698: x 1,
DA 2628: x 2
- ⑥ Control panel
- ⑦ Control for switching the lighting on and off and for dimming the cooktop lighting
- ⑧ On/Off touch control for the fan
- ⑨ Touch controls for selecting the fan power level
- ⑩ Touch control for the run-on function
- ⑪ Touch control for the operating hours counter

Description of the functions

Depending on the model of the rangehood, the following options are available:

Air extraction mode

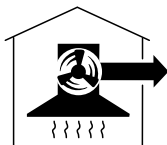

The cooking vapours are drawn in by the rangehood. The air is then passed via the edge extraction panel through the grease filters, cleaned and then directed outside.

da101814a

Recirculation mode



The air is drawn in and passed via the edge extraction panel through the grease filters and then through two charcoal filters. The cleaned air is then recirculated back into the kitchen.

DA 2628 cannot be used as a recirculation mode rangehood.

Operation with an external motor

(EXT/EXTA model rangehoods)

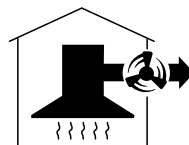

Rangehoods designed for use with an external motor have to be connected to a Miele external motor located in a position of your choice outside the room. The external motor is connected to the rangehood by means of a control cable and is operated via Con@ctivity or by the controls on the rangehood.



da101814b

da101814c



Selecting extraction mode or recirculation mode

The rangehood can be operated with either extraction mode or recirculation mode. The power of the fan is adapted to suit the selected mode of operation. The rangehood is set up at the factory for recirculation mode. It has to be re-set for extraction mode.

To re-set it for extraction mode the operating hours counter for the charcoal filter(s) has to be deactivated.

- Switch off the fan and the lighting.
- Press the + control and the operating hours control   at the same time.

The charcoal filter symbol  and one of the fan power levels will flash.

- Press and hold the + control until the **B** indicator lights up.
- Confirm your selection by pressing the operating hours control  .

All the indicator lights will go out.

Extraction mode has now been set.

If you do not confirm your selection within 4 minutes, the rangehood will automatically revert to the previous setting.

Setting up Miele@home

Prerequisites:

- a Wi-Fi network
- the Miele@mobile App
- a Miele user account. The user account can be created via the Miele@mobile App.

Your rangehood is equipped with an integrated Wi-Fi module. Connect the rangehood to your household Wi-Fi network. You will then be able to operate the rangehood via the Miele@mobile App.

If your Miele cooktop is connected to a home Wi-Fi network, you can control the rangehood automatically via the Con@ctivity function.

Before installing the rangehood in its final location, ensure that the signal of your Wi-Fi network is strong enough.

You can connect to the Wi-Fi network via the Miele@home App or via WPS.

Before using for the first time

Miele@mobile App

You can download the Miele@mobile App from the Apple App Store® or the Google Play Store™ free of charge (only functional in selected countries).



Connecting via the App

The Miele@mobile App can be used to connect to your network.

- Install the Miele@mobile App on your mobile device.

To log in you will need:

1. Your Wi-Fi network password
2. Your rangehood password

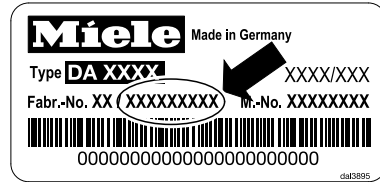

The password for your rangehood consists of the last nine digits of the serial number, which can be found on the appliance's data plate.

The data plate is visible after removing the grease filters.



- Start the appliance registration in the App. Follow the login steps.

Before using for the first time

If requested to activate Wi-Fi on the rangehood, proceed as follows:

- Manually switch the rangehood off.



- Press and hold the + control.



- Press the lighting control  at the same time.

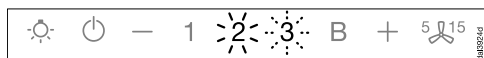

2 will light up constantly, **3** will flash on and off.

The rangehood is ready for connection during the next two minutes.



- Follow the instructions in the App.

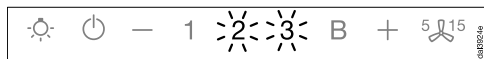

When successfully connected **2** and **3** will light up constantly.



- Quit connection mode on the rangehood by pressing the run-on control .

The rangehood can now be operated via the App.

Connecting via WPS

Your Wi-Fi router must support WPS (Wi-Fi Protected Setup).

- Manually switch the rangehood off.



- Press and hold the + control.



- Press the lighting control  at the same time.

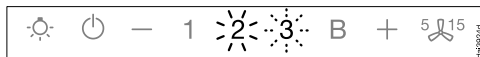

2 will light up constantly, **3** will flash on and off.

The Wi-Fi connection must be started on the rangehood at the same time as on the Wi-Fi router.

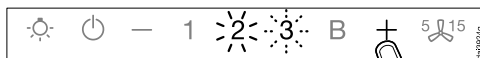

- Press the + control on the rangehood after a few seconds.

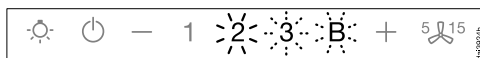

After a short while **2** will light up constantly, and **3** and **B** will flash on and off.

The rangehood is ready for connection during the next two minutes.

Before using for the first time



- Start the Wi-Fi connection on your Wi-Fi router.

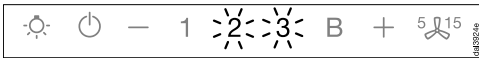

When successfully connected **2** and **3** will light up constantly.



- Quit connection mode on the rangehood by pressing the run-on control **5** .

The rangehood can now be operated via the App.

If the connection fails, you have probably not connected WPS to your router quickly enough. Repeat the steps above.

Useful tip: If your Wi-Fi router does not support WPS, please connect via the Miele@mobile App.

Signing out of Wi-Fi (reset to factory settings)

To set up a new Wi-Fi connection, the existing Wi-Fi connection must first be disconnected.

- Manually switch the rangehood off.



- Press and hold the **-** control.



- Touch the lighting control  at the same time.

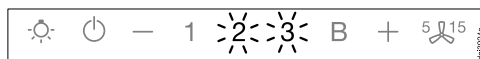

With an existing Wi-Fi connection **2** and **3** will light up constantly.

The rangehood is ready for disconnection during the next two minutes.

Before using for the first time



- Touch the — control.

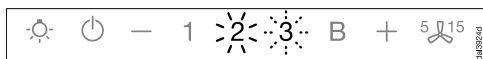

2 will light up constantly, **3** will flash on and off.

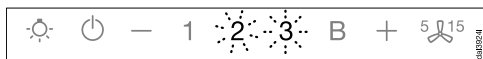

After a few seconds **2** and **3** will flash on and off. The connection has now been disconnected.



- Quit disconnection mode on the rangehood by pressing the run-on control .

The Wi-Fi connection has been disconnected. A new connection can now be set up.

Setting up Con@ctivity

Con@ctivity is the direct communication system between an electric Miele cooktop and a Miele rangehood. It enables the rangehood to operate automatically depending on the operational state of a Miele cooktop with onset controls.

- When the cooktop is switched on, the cooktop lighting on the rangehood comes on independently and, after a short time, the fan also switches on.
- The rangehood selects the power level automatically during cooking. The power level selected by the rangehood depends on the number of cooking zones being used and their power levels.
- After switching the cooktop off, the fan and the cooktop lighting will switch off automatically after a specified period of time.

See “Operation” for detailed information about this function.

Before using for the first time

Con@ctivity via the home Wi-Fi network (Con@ctivity 3.0)

Prerequisites:

- Home Wi-Fi network
- Wi-Fi enabled Miele cooktop

- Connect the rangehood and cooktop to your home Wi-Fi network (see "Setting up Miele@home").

The Con@ctivity function will be activated automatically.

Con@ctivity via a direct Wi-Fi connection (Con@ctivity 3.0)

Prerequisite:

- Wi-Fi enabled Miele cooktop

If you do not have a home network, you can establish a direct connection between the cooktop and the rangehood.

See the cooktop operating instructions for details on how to connect them.

Instructions on how to connect the rangehood are repeated in detail below.

- Manually switch the rangehood off.



- Press and hold the + control.



- Press the — control at the same time.

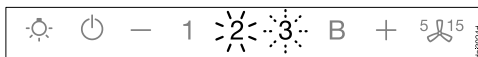

2 will light up constantly, **3** will flash on and off.

The rangehood is ready for connection during the next two minutes.

Before using for the first time

- Start the Wi-Fi connection on the cooktop. For further details, see the cooktop operating instructions.

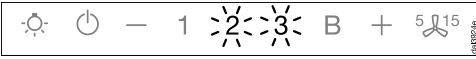

When successfully connected **2** and **3** will light up constantly.



- Quit connection mode on the rangehood by pressing the run-on control ⁵15.

Con@ctivity has now been activated.

With a direct Wi-Fi connection, it is not possible to connect the cooktop and the rangehood to a home network. Should this be required at a later date, the direct Wi-Fi connection between the cooktop and the rangehood must be disconnected first (see "Signing out of Wi-Fi").

Operation (automatic mode)

When Con@ctivity is active, the rangehood always operates in automatic mode (see “Before using for the first time – Setting up Con@ctivity”).

If you wish to manually operate the rangehood, see “Operation (manual mode) – Cooking without Con@ctivity”.

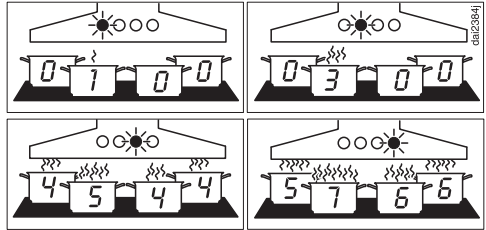

Examples for power levels 1 to 6

Cooking with Con@ctivity (automatic mode)

- Switch on a cooking zone at any power level.

The cooktop lighting will come on.

After a few seconds the fan will switch on, first at power level 2, then it will switch immediately to power level 1.

The rangehood selects the power level automatically during cooking.

This is determined by the total output of the cooktop, i.e. the number of cooking zones in operation and the power levels selected.

If you select a higher power level on the cooktop or are using several cooking zones, the rangehood will switch to a higher power level.

When you reduce the power level on the cooktop or the number of cooking zones being used, the rangehood power level will also be reduced.

Reaction time

The rangehood reacts with a slight delay because altering the power level on the cooktop does not immediately result in a reduction or increase in cooking vapours.

Because the cooktop transmits the information to the rangehood at intervals, this can also cause delays.

The reaction can vary from a few seconds to a few minutes.

Cooking process

- For example, you switch on a cooking zone at the highest power level to heat a pan for frying. After approx. 10 seconds to 4 minutes, you then reduce the power level (60 seconds to 5 minutes for a radiant cooktop).

The rangehood recognises a cooking process.

The rangehood switches itself on and when the cooktop power level has been reduced, the rangehood switches to power level 3 and remains at that level for approx. 5 minutes.

After that the rangehood power level is determined automatically by the Con@ctivity function.

You can select another power level manually before then.

Switching off

- Switch off all cooking zones.

The rangehood fan will reduce its power level in stages over the next few minutes and will then switch itself off.

This helps to neutralise any lingering vapours and odours in the air.

- From the Booster setting, the fan switches immediately to level 3.
- From level 3, it will switch to level 2 after approx. 1 minute.
- From level 2, it will switch to level 1 after 2 minutes.
- After 2 minutes at Level 1, the fan switches itself off.
- After another 30 seconds, the cooktop lighting switches off.

The cooking process is then finished.

Operation (automatic mode)

Leaving automatic mode temporarily

To leave automatic mode temporarily during cooking:

- Manually select a different power level, or
- Manually switch the rangehood off, or
- Activate the run-on function  on the rangehood. The fan will switch itself off after the selected run-on time, and the lighting will remain on.

The rangehood functions are now operated manually (see “Operation (manual mode)”).

Returning to automatic mode

The rangehood returns to automatic mode:

- if the rangehood has not been used for approx. 5 minutes after selecting a power level manually, or
- if the manually selected power level corresponds to the automatic one again, or
- the rangehood fan and the cooktop have been switched off for at least 30 seconds.
Automatic mode will resume next time the cooktop is switched on.

You can also operate the rangehood manually for a complete cooking process.

- To do so switch the rangehood fan on **before** the cooktop.

If the rangehood fan and the cooktop have been switched off for at least 30 seconds after cooking, automatic mode will resume next time the cooktop is switched on.

Cooking without Con@ctivity (manual mode)

The rangehood can be operated manually if:

- the Con@ctivity function is not activated.
- You have temporarily deactivated the Con@ctivity function (see “Operation (manual operation) – Leaving automatic mode temporarily”).

Switching the fan on

Switch the fan on as soon as you start cooking. This is to ensure that vapours are captured right from the start.

- Press the On/Off touch control .

The fan will switch on at setting **2**. The  symbol and **2** will light up in the power level display.

Selecting a power level

For light to heavy cooking vapours and odours, select from power levels **1** to **3**.

For short periods of cooking food with intensive vapours and a strong aroma, e.g. when searing meat, select Booster setting **B**.

- Select the power level you want by pressing the – or + controls.

Reducing power down from the Booster setting



If Power management is activated (default setting), the fan automatically switches back to level **3** after 5 minutes.

Selecting the run-on time

It is advisable to run the fan for a few minutes after cooking has finished. This helps to neutralise any lingering vapours and odours in the air.

It also reduces the risk of residues accumulating in the rangehood and any resultant odours.

The run-on function allows the fan to continue to run for a pre-determined time before switching itself off automatically.

- After cooking has finished, press the run-on control  while the fan is still running:
 - Once: the fan will switch itself off after 5 minutes (**5** lights up).
 - Twice: the fan will switch itself off after 15 minutes (**15** lights up).
 - If you touch the run-on control  again, the fan will remain switched on ( will go out).

Switching the fan off

- Press the On/Off touch control  to switch the fan off.

The  symbol will go out.



Operation (manual mode)

Dimming/switching the cooktop lighting on/off

The cooktop lighting can be switched on and off and dimmed independently of the fan.

- Press the lighting control  briefly to switch it on or off.

The lighting will switch on at maximum brightness.

- To change the brightness, press and hold the lighting control  with the lighting switched on. The brightness will gradually dim until you release the control.
- To increase the brightness, press and hold the lighting  control again until the desired level has been reached and then release it.

Power management



The rangehood is fitted with a Power management system. The Power management system is designed to help save energy. It ensures that the fan power level is reduced automatically and that the lighting is switched off.

- If the Booster setting has been selected, the fan will automatically switch to setting 3 after 5 minutes.
- From fan power levels 3, 2 and 1, the power will be reduced by one level after 2 hours and then in 30-minute stages until the fan finally switches off.
- The cooktop lighting will switch off automatically after 12 hours.

You can deactivate Power management.

Keep in mind that deactivating this function may increase energy consumption.

Activating/deactivating Power management

- Switch off the fan and the lighting.
- Press the run-on control ⁵ for approx. 10 seconds, until the indicator for power level 1 lights up.
- Then press in turn:
 - the lighting control ,
 - the — control, and again
 - the lighting control .

When Power management is activated, the **1** and **B** indicators light up constantly.

When it is deactivated, the **1** and **B** indicators flash.

- Press the — control to deactivate Power management.

The **1** and **B** indicators will flash.

- Press the + control to activate Power management.

The **1** and **B** indicators will light up constantly.



- Confirm the setting by pressing the run-on control .

All the indicator lights will go out.

If you do not confirm your selection of setting within 4 minutes, the rangehood will revert to the previous setting.

Safety switch-off



If Power management has been deactivated, the rangehood will switch itself off automatically after 12 hours if it has been left on (fan and cooktop lighting).

- To switch it back on press the On/Off  control or the lighting control .

Operation (automatic and manual modes)

Operating hours counter

The rangehood registers the length of time it has been operated.



When the grease filter symbol  or the charcoal filter symbol  lights up, the operating hours counters are signalling that the filters need to be cleaned or replaced. Further information about cleaning and replacing the filters and resetting the operating hours counters can be found under “Cleaning and care”.

Altering the grease filter operating hours counter

You can set the operating hours counter to suit the type of cooking you do.

The factory setting is a cleaning interval of 30 hours.



- Select a shorter time of 20 hours if you fry a lot.
- If you only cook occasionally, we recommend that you still select a short time for the counter. This is to prevent grease from hardening on the filter and making cleaning more difficult.
- Select a longer time of 40 or 50 hours if you use very little fat for cooking.

- Switch off the fan and the lighting.
- Press the ⁵↵¹⁵ control and the operating hours control   at the same time.

The grease filter symbol  and one of the fan power level indicators will flash.

The fan power level indicators **1** to **B** show the time set:

| | |
|----------------|----------|
| 1 | 20 hours |
| 2 | 30 hours |
| 3 | 40 hours |
| B | 50 hours |

- Press the — control for a shorter duration, or + for a longer duration.
- Confirm your selection by pressing the operating hours control  .

All the indicator lights will go out.

If you do not confirm your selection within 4 minutes, the rangehood will automatically revert to the previous setting.

Operation (automatic and manual modes)



Altering or deactivating the charcoal filter operating hours counter

Charcoal filters are needed for recirculation mode.

You can set the operating hours counter to suit the type of cooking you do.

It has to be deactivated for extraction mode.



It is set at the factory for 180 hours of use before the filters need replacing.

- Switch off the fan and the lighting.
- Press the + control and the operating hours control   at the same time.

The charcoal filter symbol  and one of the fan power levels will flash.

The fan power level indicators **1** to **B** show the time set:

- 1**..... 120 hours
- 2**..... 180 hours
- 3**..... 240 hours
- B**..... deactivated





- Select the duration you want with the + or – control.
- Confirm your selection by pressing the operating hours control  .

All the indicator lights will go out.

If you do not confirm your selection within 4 minutes, the rangehood will automatically revert to the previous setting.

Reading the filter operating hours counter

You can check the percentage of time set already used before the filters need replacing.

- Switch the fan on with the On/Off touch control .
- Press and hold the operating hours control  :
 - Once, to read the grease filter operating hours. The grease filter symbol  lights up.
 - Twice, to read the charcoal filter operating hours. The charcoal filter symbol  lights up.

One or more of the fan power level indicators will flash.

The number of flashing indicators shows the percentage of the operating time which has already been used up.

- 1** 25 %
- 1 and 2** 50 %
- 1 to 3** 75 %
- 1 to B** 100 %

The number of operating hours used remains in the memory even when the appliance is switched off or there is a power cut.

Energy saving tips

This rangehood operates very efficiently and economically. The following will help you to save even more energy when using it:

- Ensure that there is sufficient ventilation in the kitchen when cooking. In extraction mode, if there is insufficient air flow the rangehood cannot operate efficiently and this causes increased operating noise levels.
- Always cook with the lowest possible setting. This produces fewer cooking vapours, so you can use a lower rangehood power level and therefore benefit from reduced energy consumption.
- Clean or change the filters at regular intervals. Heavily soiled filters reduce performance, increase the risk of fire and are unhygienic.
- Use the Con@ctivity function. The rangehood will switch on and off automatically. The rangehood will select the optimum power level for the cooking you are doing, which ensures low energy consumption.
- If you are operating the rangehood manually, please note the following:
 - Check the power level selected on the rangehood. A low power level is usually sufficient. Only use the Booster setting when necessary.
 - When a large volume of cooking vapours are being produced, switch to a high power level in good time. This is more efficient than operating the rangehood for longer to try to capture cooking vapours which have already been distributed throughout the kitchen.
 - Make sure that you switch the rangehood off after use. If cooking vapours and odours still need to be removed from the kitchen air after cooking, use the run-on function. The fan will switch off automatically after the selected run-on time.

 Before carrying out any maintenance or cleaning, the rangehood must be disconnected from the electricity supply (see “Warning and Safety instructions”).

Housing

General information

Unsuitable cleaning agents can damage the surfaces and control elements.

Do not use any cleaning agents containing soda, acid, chloride, or solvent.

Do not use any abrasive cleaning agents, e.g. powder cleaners or cream cleaners and abrasive sponges, or pot scourers or sponges which have been used previously with abrasive cleaning agents.

 Moisture in the rangehood can cause damage.
Make sure that water does not get into the rangehood.

- Clean all surfaces and control elements using a small amount of warm water and dishwashing liquid. Apply with a soft sponge.
- After cleaning, wipe the surfaces dry using a soft cloth.

Important information for appliances with stainless steel surfaces

This information does not apply to the control elements.

Stainless steel surfaces can be cleaned with a non-abrasive cleaning agent designed specifically for use on stainless steel.

To prevent the surfaces from quickly becoming dirty again, we recommend treating them with a stainless steel care product (available from Miele).

Important information for the control elements

If soiling is not removed promptly, it could cause the control elements to alter or discolor.

Remove any soiling immediately.

The surface of the control elements can be damaged if they are cleaned using stainless steel cleaning agents. Do not use stainless steel cleaning agents on the control elements.

Cleaning and care

Grease filters and edge extraction panel

 Fire hazard!

Oversaturated grease filters are a fire hazard.

Clean the grease filters at regular intervals.

The edge extraction panel and the re-usable metal grease filters in the appliance remove solid particles (grease, dust, etc.) from the kitchen vapours, preventing soiling of the rangehood.

The grease filters and the panel must be cleaned at regular intervals.

Heavily soiled grease filters hinder air extraction and will lead to increased levels of soiling in the rangehood and in the kitchen.

Grease filter cleaning intervals

Grease which has collected in the rangehood hardens over time and makes cleaning more difficult. It is therefore recommended that the edge extraction panel and the grease filters should be cleaned regularly (at least every 3–4 weeks) to avoid a build-up of grease.

The operating hours counter reminds you to clean the edge extraction panel and the grease filters regularly by illuminating the grease filter symbol .

You can set the operating hours counter interval to suit the type of cooking you do (see “Operation (automatic and manual modes)”).

Removing the panel and grease filters

 The panel and grease filter can fall out when you are handling them. This can result in damage. Make sure you hold the panel and the grease filter securely at all times when handling them.

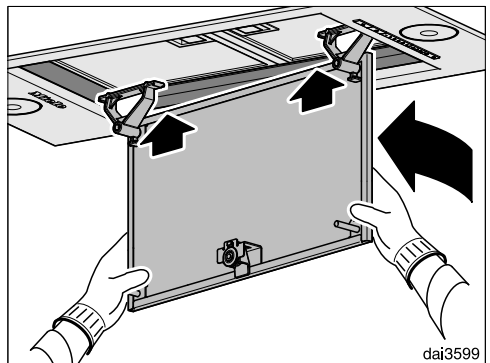
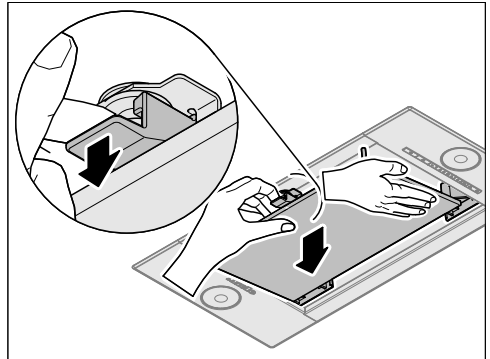

- Hold the panel with one hand and release the catch with the other hand. Lower the panel.
- Lift the panel slightly upwards, and then lift it forwards to remove it.

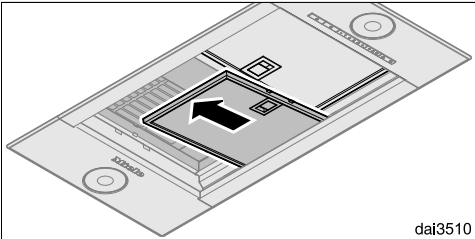
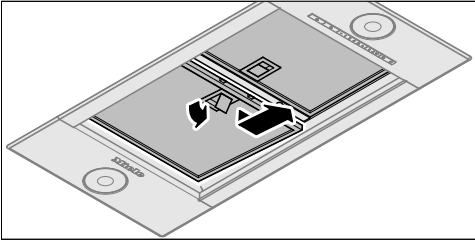

- Open the grease filter retainer catch and remove the filter.

Cleaning the panel by hand

- For cleaning the panel, follow the instructions provided under “Housing”.

Cleaning the grease filters by hand

- Clean the filters with a soft nylon brush in a mild solution of hot water and a small amount of washing-up liquid. Do not use undiluted washing up liquid.

Unsuitable cleaning agents

Unsuitable cleaning agents can cause damage to the surface of the filters if used regularly.

Do not use:

- cleaning agents containing descaling agents,
- powder cleaners or cream cleaners,
- aggressive all-purpose cleaning agents or spray cleaners for grease,
- oven sprays.

Cleaning the panel and the grease filters in the dishwasher

- Place the panel and the grease filters upright or slightly inclined in the lower basket. Ensure the spray arm is not obstructed.
- Use a standard household dishwasher detergent.
- Select a dishwasher programme with a wash temperature between 50 °C and 65 °C.

Depending on the detergent used, cleaning the filters in the dishwasher may cause the inside filter surfaces to become discoloured. This will not affect the functioning of the grease filters in any way.

Cleaning and care

After cleaning

- After cleaning, leave the filters to dry on an absorbent surface before refitting them.
- When removing the filters and panel for cleaning, also clean off any residues of oil or fat from the now accessible housing to prevent the risk of these catching fire.
- Replace the grease filters, making sure that the locking clips are facing down towards the cooktop.

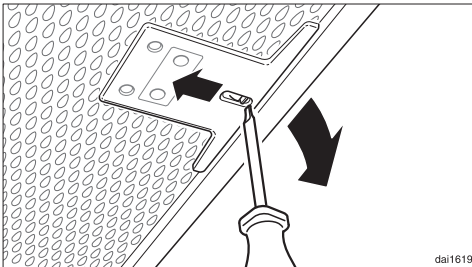

- If a grease filter is inadvertently refitted upside down, insert a small screwdriver blade into the slit to disengage the clip.

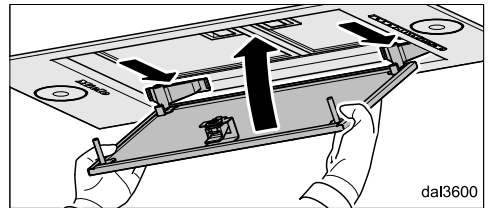
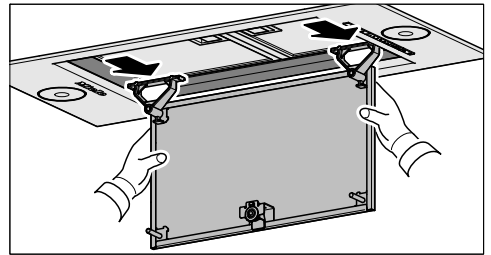
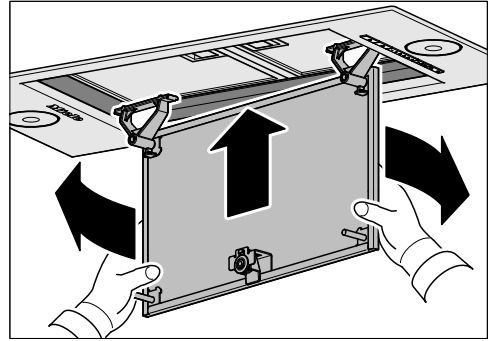



- Lift the panel into the canopy and hook it in at the back.
- Tilt the panel upwards at the front and press it into the locking clip.

The panel can also be turned 180° and fitted. Depending on where the rangehood is installed, this can make it easier to remove and refit the panel.

Resetting the grease filter operating hours counter

After cleaning, the operating hours counter needs to be reset.

- While the fan is switched on, press the operating hours control  for approx. 3 seconds until only **1** is flashing.

The grease filter symbol  goes out.

If the grease filters are cleaned before the operating hours counter has reached its maximum:

- Press the operating hours control  for approx. 6 seconds until only **1** is flashing.

NoSmell active charcoal filters

With recirculation mode, two charcoal filters must be fitted in addition to the grease filters. These are designed to absorb cooking odours.

The charcoal filters are fitted in the canopy above the grease filters.

Charcoal filters are available to order via the Miele online shop (see the end of this booklet for contact details) or directly from Miele. The part number of the charcoal filter required is listed under “Technical data”.

Fitting and replacing the charcoal filters

- Before fitting or replacing the charcoal filters, the panel and the grease filters must first be taken out (see previous section for instructions on how to do this).
- Unwrap the charcoal filters.

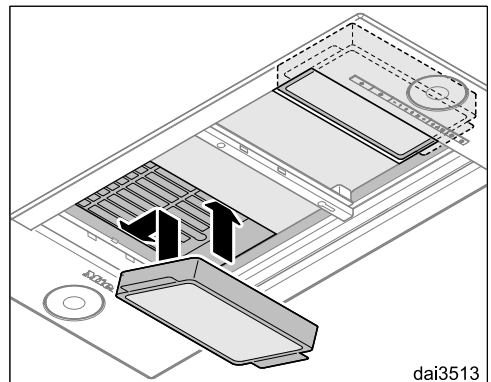

- Press the charcoal filters into the frame.
- Refit the grease filters.

Cleaning and care

When to change the NoSmell active charcoal filters

Replace the charcoal filters when they no longer absorb kitchen odours effectively, or at least every 6 months.

The operating hours counter will remind you to replace the charcoal filters by lighting up the charcoal filter symbol .

Resetting the charcoal filter operating hours counter

After changing the charcoal filters, the operating hours counter needs to be reset.

- To do this, with the fan switched on, press the operating hours control  twice, then press it again and hold it for approx. 3 seconds until only **1** is flashing.

The charcoal filter symbol  goes out.

If you want to replace the charcoal filters **before** the operating hours counter has reached its maximum:

- Press the operating hours control  twice and hold it for approx. 6 seconds until only **1** is flashing.

Disposing of the charcoal filters

- Used charcoal filters can be disposed of with the normal household waste.

Before installation

 Before installation, it is important to read the information given on the following pages as well as the “Warning and Safety instructions” at the beginning of this booklet.

The rangehood is intended to be built into wall units, rangehood housing units, and above breakfast bars or island areas.

- Check prior to installation that the top of the appliance will be accessible after installation.

If this is not the case, install the exhaust ducting and prepare the mains connection **before** installation.

Installation instructions

See enclosed installation sheet for instructions on how to install this appliance.

 Failure to install the screws or fixing device in accordance with these instructions may result in electrical hazards.

Installation recommendations

- When deciding on the safety distance between the cooktop and rangehood, please note that a distance of 650 mm above electric cooktops may be preferable to give more working space under the rangehood.
- Account should also be taken of the height of the person who will be using the rangehood most often. They should have sufficient space to work comfortably at the cooktop, and be able to reach the rangehood controls with ease.
- If positioned too high, extraction will be inefficient.
- To achieve optimum vapour extraction, the rangehood must be centred over the cooktop, not to the side or behind it.
- The cooktop should be no wider than the rangehood and, if possible, it should be narrower, especially for safety distances greater than 750 mm.
- The installation area must be easily accessible. The rangehood should be easily accessible and easy to dismantle in the event that service is required. This should be taken into consideration when planning the position of cupboards, shelves, ceilings or features in the vicinity of the rangehood.

Installation

Installation materials

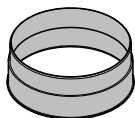

1 exhaust connection for exhaust ducting \varnothing 150 mm

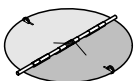

1 non-return flap for fitting into the exhaust connection on the motor unit (not needed for recirculation mode). Depending on model, the non-return flap may already be fitted.

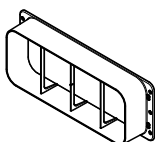

1 connector for flat ducting to the rear or the side (only for EXTA models)

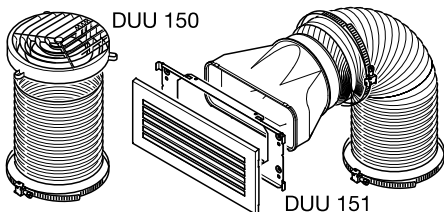

Conversion kit for recirculation mode (the conversion kit is not supplied and must be ordered separately; see "Technical data"). The kit contains an exhaust grille and aluminium hose with hose clips.

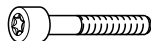

08665780

7761730



00010689



8166620

4 M5 x 40 mm screws, 4 washers, 4 M5 nuts for securing the rangehood to an interim shelf

08272520



08095672

10 M4 x 8 mm screws for securing the rangehood, and with EXT models for securing flat ducting and the cover to the casing

Stutzen Flech

Keep the following in a safe place:

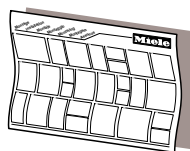

dfire3mb

Installation plan

Appliance dimensions

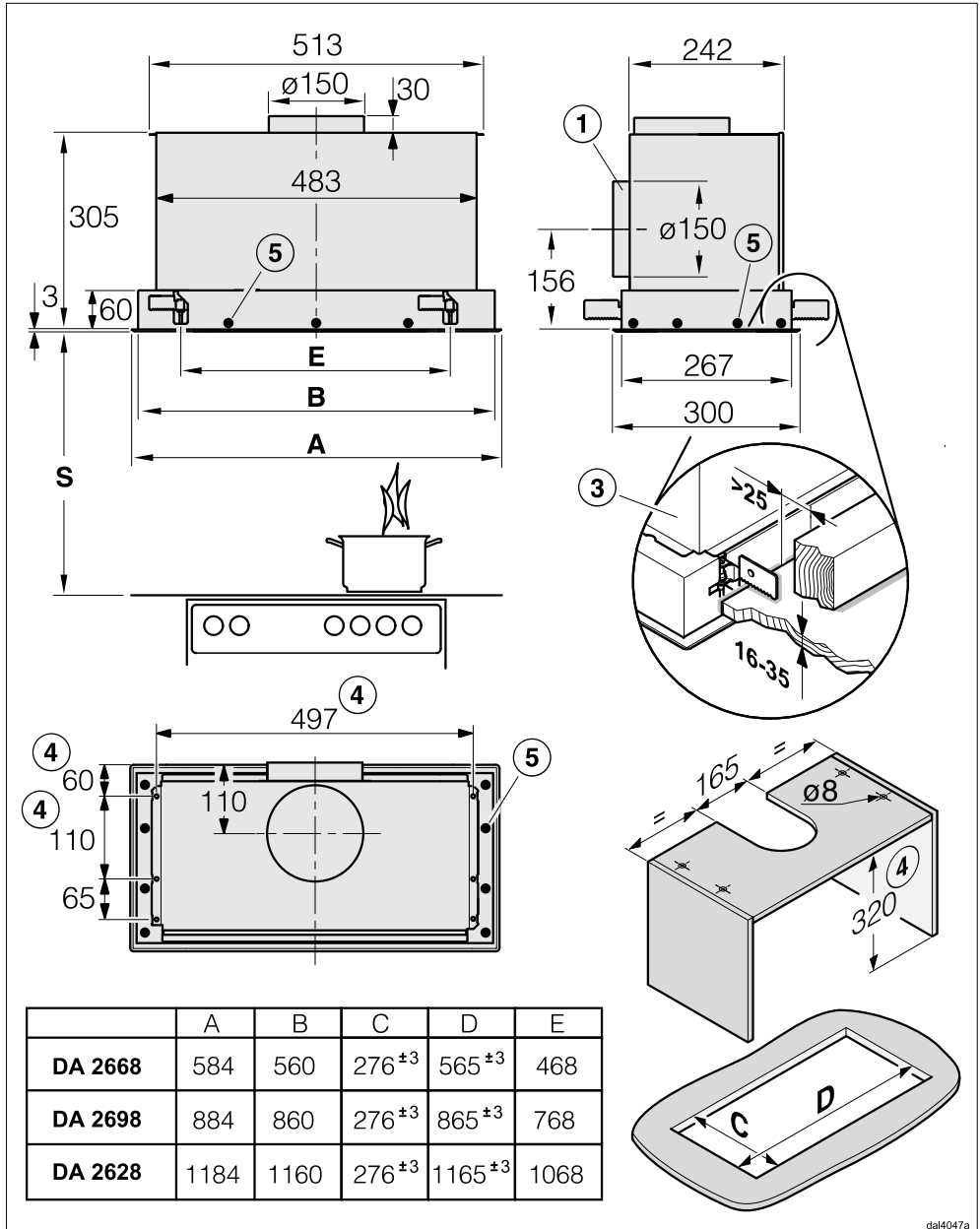

dal4047a

The drawing is not to scale

Installation

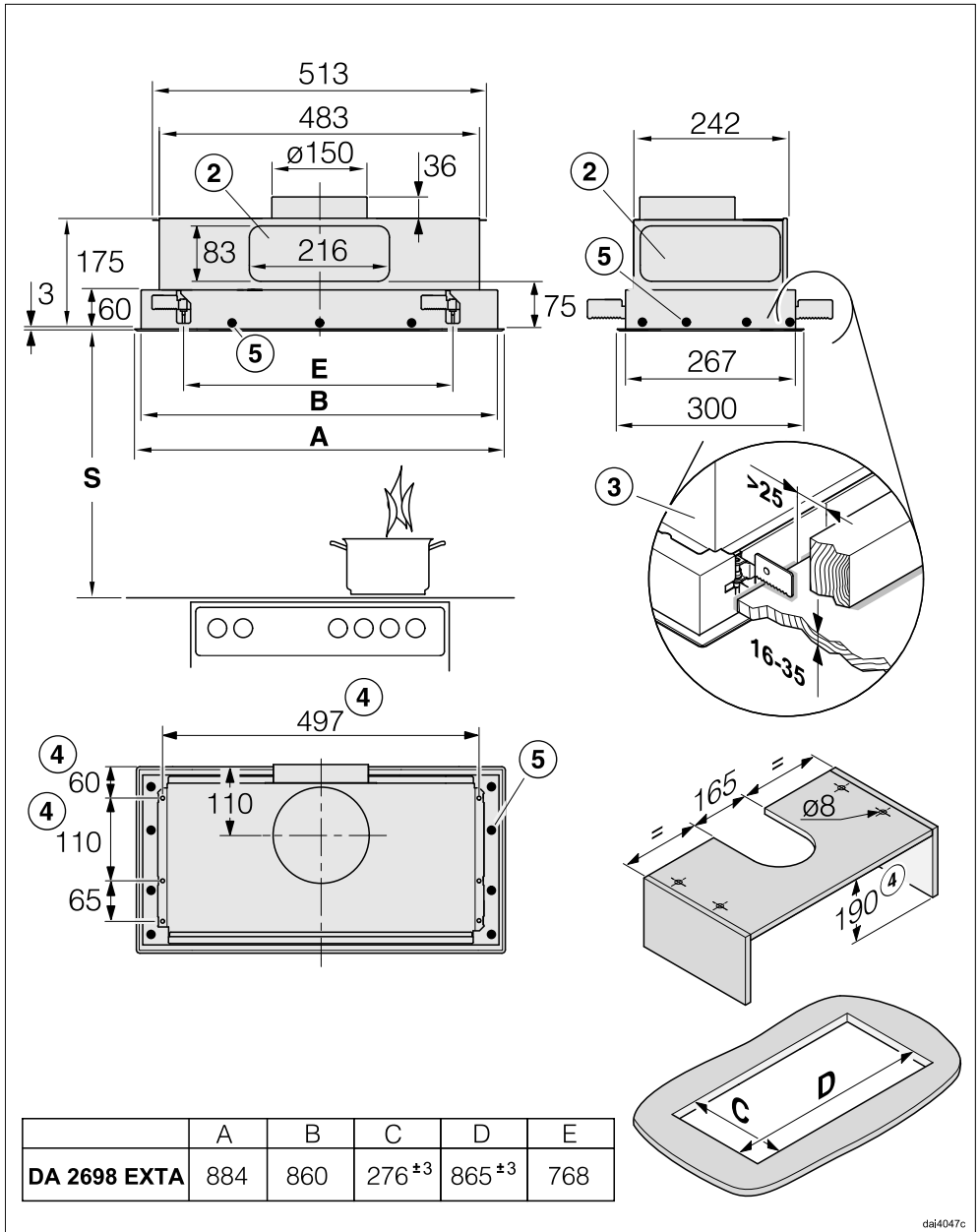

daj4047c

The drawing is not to scale

- ① The ducting can also be connected at the back.
- ② 222 x 89 mm flat ducting can be used as an alternative for ducting to the rear or to the side.
- ③ The rangehood is fastened in the cut-out using clamps. A solid installation surface, e.g., made of wood, is required. Make sure that the structure can support the load. Around the clamps, components such as supports and ducting must be at least 25 mm from the cut-out.
- ④ Alternatively, the rangehood can be secured to four fixing points on an interim shelf.
- ⑤ There are additional fixing points on the installation surface.

Safety distance (S)

The minimum distances between the cooking surface of a cooktop (pan support(s) for gas models) and the bottom of the rangehood are as follows, unless a greater distance is specified by the manufacturer of your cooking appliance. See also “Warning and Safety instructions”.

| Cooking appliance | Minimum distance S |
|--|---|
| Electric cooktop | 600 mm (AU, NZ) 450 mm (HK, MY, SG, TH, TW) |
| Electric grill, deep fat fryer (electric) | 650 mm |
| Multi-burner gas cooktop with maximum 45.4 MJ/h total output, with no burner having a greater output than 16.2 MJ/h. | 650 mm |
| Multi-burner gas cooktop with total output greater than 45.4 MJ/h, but with a maximum of 77.8 MJ/h, with no burner having a greater output than 17.3 MJ/h. | 760 mm |
| Multi-burner gas cooktop with total output greater than 77.8 MJ/h, with a single burner having a greater output than 17.3 MJ/h. | Not possible |
| Single burner gas cooktop with a maximum output of 21.6 MJ/h. | 650 mm |
| Single burner gas cooktop with an output greater than 21.6 MJ/h, but with a maximum of 29.2 MJ/h. | 760 mm |
| Single burner gas cooktop with an output greater than 29.2 MJ/h. | Not possible |

Installation

Uneven installation surfaces

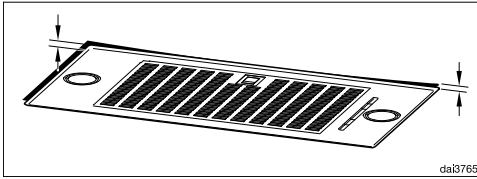

If the installation surface is uneven and therefore making flush installation difficult, the frame can be realigned.

- Fit the rangehood as described on the installation sheet.

Warning! Danger of electric shock!
Disconnect the rangehood from the mains electricity supply before removing the lamps (see “Warning and Safety instructions”).

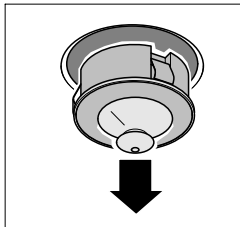
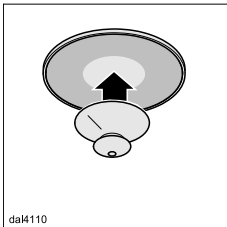

- Using the suction cup supplied, pull the lamp out of its holder.
- Remove all other lamps in the same way.

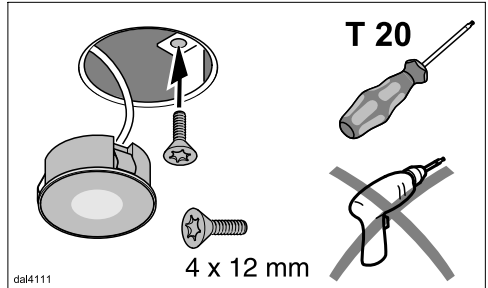

- Fit one of the screws supplied into the eyelet of the fixing tab located inside each lamp opening as depicted in the diagram above.
- Tighten the screws with a screwdriver until the frame sits flush with the installation surface.

Do not overtighten the screws.

- Refit the lamps.

Connection for air extraction

 Before installation, it is important to read the information given on the following pages as well as the “Appliance dimensions” and the “Warning and Safety instructions” at the beginning of this booklet. This is particularly crucial when using the rangehood at the same time as a heating appliance that relies on oxygen from the same room, which could result in the build-up of toxic fumes.

The rangehood should be installed according to local and national building regulations. Seek approval from the building inspector where necessary.

Only use smooth pipes or flexible ducting made from approved non-flammable materials for exhaust ducting.

When using an external motor, make sure that the exhaust ducting is sufficiently rigid. The external motor can cause an underpressure which can result in the exhaust ducting distorting.

To achieve the greatest possible air extraction with the lowest noise level, please note the following:

- The diameter of the exhaust ducting should not be less than 150 mm.
- If flat ducting is being used, the cross-sectional area must not be smaller than the cross-sectional area of the exhaust connection.

- The exhaust ducting should be as short and straight as possible.
- Only use wide radius bends.
- The exhaust ducting must not be kinked or compressed.
- Ensure that all connections are strong and airtight.
- If the ducting has flaps, these must be opened when the rangehood is switched on.

Remember that any constriction of the airflow will reduce extraction performance and increase operating noise.

- If the exhaust is ducted through an outside wall, a telescopic wall vent or a roof vent (available as an optional accessory) is recommended.

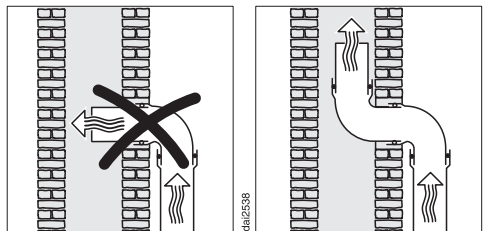

- If the exhaust air is to be ducted into a vent flue, the ducting must be directed in the flow direction of the flue.
- If the flue is used by several ventilation units, the cross-section of the flue must be large enough.
- Where ducting is horizontal, it must be laid to slope away at at least 1 cm per metre. This is to ensure that condensate cannot drain back into the rangehood.

Installation

- If the exhaust ducting is to run through rooms, ceiling space etc. there may be great variations in temperature between the different areas. The problem of condensation will need to be addressed. The exhaust ducting will need to be suitably insulated.

Miele will not accept warranty claims for any functional defects or damage caused by inadequate ducting.

Silencer

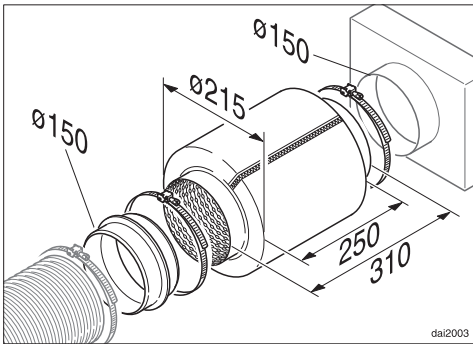

To achieve even further reductions in noise levels, a special silencer (optional accessory) can be fitted in the ducting system.

Air extraction mode

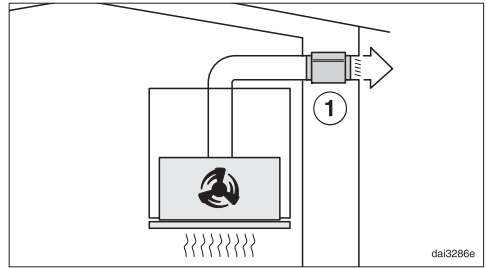

The silencer not only reduces noise from the motor outside the house, but also sounds from outside (e.g. traffic noise). For this reason, the silencer must be positioned as close as possible to the ducting exit ①.

Air extraction with external motor

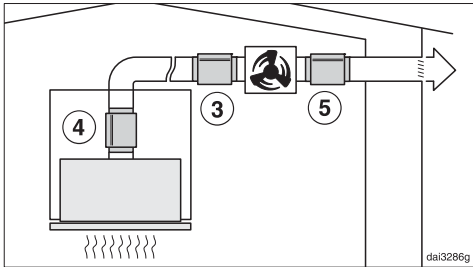

To minimise noise from the motor in the kitchen, the silencer should be positioned in front of the external motor ③ if possible, or, if the ducting is long, above the exhaust connection inside the rangehood ④. In the case of an external motor located inside the house, fitting a silencer behind the external motor ⑤ reduces the noise of the motor outside the house.

Electrical connection

The rangehood must only be connected to a properly installed AC 230 V ~ 50 Hz earthed socket.

The electrical installation must be in compliance with current local and national safety regulations.

For extra safety, it is advisable to protect the appliance with a suitable residual current device (RCD) with a trip current of 30 mA.

Connection via a socket is recommended as it facilitates servicing of the appliance. The socket should be easily accessible after the appliance has been installed.

If the socket is no longer accessible after installation, an additional means of disconnection must be provided for all poles which complies with national and local safety regulations. Suitable means of disconnection include switches with an all-pole contact gap of at least 3 mm.

These include isolator switches, fuses and relays.

The relevant connection data can be found on the data plate (see "Service"). Ensure that this data matches the voltage and frequency of your household mains supply.

Service

Contact in case of fault

In the event of any faults which you cannot remedy yourself, please contact Miele.

You can book a Miele customer service call-out online at www.miele.com.au/service or www.miele.co.nz/service.

Contact information for Miele can be found at the end of this booklet.

Please quote the model and serial number of your appliance when contacting Miele. This information can be found on the data plate.

Position of the data plate

The data plate is visible after removing the grease filters.

Warranty

The manufacturer's warranty for this appliance is 2 years.

For further information, please refer to your warranty booklet.

Technical data

| | |
|-------------------------------|-----------------|
| Fan motor* | 230 W |
| Cooktop lighting | |
| DA 2668 | 2 x 4.5 W |
| DA 2698 | 4 x 3 W |
| DA 2628 | 3 x 4.5 W |
| Total rated load* | |
| DA 2668 | 239 W |
| DA 2698 | 242 W |
| DA 2628 | 243.5 W |
| Voltage, frequency | AC 230 V, 50 Hz |
| Fuse rating | 10 A |
| Mains connection cable length | 1.5 m |
| Weight | |
| DA 2668 | 12 kg |
| DA 2698 | 14 kg |
| DA 2628 | 15 kg |
| DA 2698 EXTA | 11 kg |

* For EXTA models, the connected load and extraction power will depend on the type of external motor fitted.

Length of connection cable to external motor: 1.9 m

Wi-Fi module

| | |
|----------------------------|------------------|
| Frequency band | 2.400–2.4835 GHz |
| Maximum transmission power | < 100 mW |

Optional accessory for recirculation mode

DUU 150 or DUU 151 conversion kit and DKF 19-1 charcoal filter set. The set contains two active charcoal filters.

Miele Australia Pty. Ltd.

ACN 005 635 398
ABN 96 005 635 398

Miele Experience Centre and
Head Office Melbourne:
1 Gilbert Park Drive
Knoxfield, VIC 3180

1300 464 353 (1300 4 MIELE)

www.miele.com.au

Hong Kong, China

Miele (Hong Kong) Ltd.
41/F - 4101, Manhattan Place
23 Wang Tai Road, Kowloon Bay
Hong Kong
Tel.: (852) 2610 1025
Fax: (852) 3579 1404
E-mail: customerservices@miele.com.hk
Website: www.miele.hk

Singapore

Miele Pte. Ltd.
29 Media Circle
#11-04 ALICE@Mediapolis
Singapore 138565
Tel.: +65-67351191
Fax: +65-67351161
E-mail: info@miele.com.sg
Internet: www.miele.sg

Miele Global Headquarters Germany

Miele & Cie. KG Carl-Miele-Straße 29, 33332 Gütersloh, Federal Republic of Germany

Miele New Zealand Ltd.

IRD 98 463 631

Head Office:
8 College Hill
Freemans Bay, Auckland 1011

0800 464 353 (0800 4 MIELE)

www.miele.co.nz

Malaysia

Miele Sdn Bhd
Suite 12-2, Level 12
Menara Sapura Kencana Petroleum
Solaris Dutamas No. 1, Jalan Dutamas 1
50480 Kuala Lumpur, Malaysia
Phone: +603-6209-0288
Fax: +603-6205-3768

Thailand

Miele Appliances Ltd.
BHIRAJ TOWER at EmQuartier
43rd Floor Unit 4301-4303
689 Sukhumvit Road
North Klongton Sub-District
Vadhana District
Bangkok 10110, Thailand

DA 2668, DA 2698, DA 2628, DA 2698 EXTA

en-AU, NZ

M.-Nr. 11 558 840 / 01