

Operating and installation instructions Electric hobs



To avoid the risk of accidents or damage to the appliance it is **essential** to read these instructions before it is installed and used for the first time.

Warning and Safety instructions	5
Caring for the environment	13
Guide to the appliance	14
Hob.....	14
KM 6565 FR	14
Controls and display	15
Cooking zones.....	17
Before using for the first time	18
Cleaning the hob for the first time	18
Switching on the hob for the first time	18
Miele@home	19
Con@ctivity.....	22
How the cooking zones work	25
Pans	26
Tips on saving energy	27
Setting range	28
Operation	29
Using the appliance.....	29
Switching on the hob	30
Setting/changing the power level.....	30
Switching off a cooking zone	30
Residual heat indicator.....	30
Power level setting - Extended setting range.....	31
Switching on an extended zone/outer ring.....	31
Auto heat-up	32
Keeping warm	33
Timer	34
Minute minder	34
Switching off a cooking zone automatically.....	35
Additional functions	36
Stop & Go.....	36
Recall.....	36
Wipe protection	37
Demonstration mode.....	37
Displaying hob data.....	37

Contents

Safety features	38
System lock/safety lock	38
Safety switch-off	40
Overheating protection / Pan protection	41
Programming	42
Cleaning and care	45
Problem solving guide	47
Optional accessories	50
After sales service	51
Contact in case of malfunction	51
Data plate	51
Guarantee.....	51
Installation	52
Safety instructions for installation	52
Safety distances	53
Installation notes	57
Building-in dimensions	58
KM 6565 FR	58
Installation	59
Electrical connection	61

Warning and Safety instructions

This hob complies with all relevant local and national safety requirements. Inappropriate use can, however, lead to personal injury and material damage.

Read the operating and installation instructions carefully before using the hob. They contain important information on safety, installation, use and maintenance. This prevents both personal injury and damage to the hob.

Miele expressly and strongly advises that you read and follow the instructions in the chapter on installing the hob as well as the safety instructions and warnings.

Miele cannot be held liable for injury or damage caused by non-compliance with these instructions.

Keep these instructions in a safe place and pass them on to any future owner.

Warning and Safety instructions

Correct application

- ▶ This hob is intended for domestic use and use in other similar environments.
- ▶ This hob is not intended for outdoor use.
- ▶ It is intended for domestic use only to cook food and keep it warm. Any other use is not supported by the manufacturer and could be dangerous.
- ▶ This hob is not intended for use by people with reduced physical, sensory or mental capabilities or lack of experience and knowledge, unless they have been given supervision and instruction concerning its use by a person responsible for their safety. They may only use the hob unsupervised if they have been shown how to use it in a safe way. They must be able to recognise and understand the dangers of misuse.

Safety with children

- ▶ Children under 8 years of age must be kept away from the hob unless they are constantly supervised.
- ▶ Children over 8 years of age may use the hob without supervision if its operation has been clearly explained to them and they are able to use it safely. Children must be able to understand and recognise the possible dangers caused by incorrect operation.
- ▶ Children must not be allowed to clean the hob unsupervised.
- ▶ Please supervise children in the vicinity of the hob and do not let them play with it.
- ▶ The hob gets hot when in use and remains hot for a while after being switched off. Keep children well away from the hob until it has cooled down and there is no danger of burning.
- ▶ Danger of burning! Do not store anything which might arouse a child's interest in storage areas above or behind the hob. Otherwise they could be tempted into climbing onto the appliance with the risk of burning themselves.
- ▶ Risk of burning and scalding. Place pots and pans on the cooking zone in such a way that children cannot pull them down and burn themselves.
- ▶ Danger of suffocation. Packaging, e.g. plastic wrappings, must be kept out of the reach of babies and children. Whilst playing, children could become entangled in packaging or pull it over their head and suffocate.
- ▶ Activate the system lock to ensure that children cannot switch on the hob inadvertently. Use the safety lock when the hob is in use to prevent children from altering the settings selected.

Warning and Safety instructions

Technical safety

- ▶ Unauthorised installation, maintenance and repairs can cause considerable danger for the user. Installation, maintenance and repairs must only be carried out by a Miele authorised technician.
- ▶ Damage to the hob can compromise your safety. Check the hob for visible signs of damage. Do not use the hob if it is damaged.
- ▶ Reliable and safe operation of this hob can only be assured if it has been connected to the mains electricity supply.
- ▶ The electrical safety of this hob can only be guaranteed when correctly earthed. It is essential that this standard safety requirement is met. If in any doubt please have the electrical installation tested by a qualified electrician.
- ▶ To avoid the risk of damage to the hob, make sure that the connection data on the data plate (voltage and frequency) match the mains electricity supply before connecting it to the mains. Consult a qualified electrician if in doubt.
- ▶ Do not connect the hob to the mains electrical supply by a multi-socket adapter or extension lead. These are a fire hazard and do not guarantee the required safety of the appliance.
- ▶ For safety reasons, this hob may only be used after it has been built in.
- ▶ This hob must not be used in a non-stationary location (e.g. on a ship).
- ▶ Never open the casing of the hob.
Touching or tampering with electrical connections or components and mechanical parts is highly dangerous to the user and can cause operational faults.
- ▶ While the hob is under warranty, repairs should only be undertaken by a Miele authorised technician. Otherwise the warranty is invalidated.

Warning and Safety instructions

- ▶ Miele can only guarantee the safety of the appliance when genuine original Miele replacement parts are used. Faulty components must only be replaced by Miele spare parts.
- ▶ The hob is not intended for use with an external timer switch or a remote control system.
- ▶ The hob must be connected to the electricity supply by a qualified electrician (see “Installation – Electrical connection”).
- ▶ If the mains connection cable is damaged, it must be replaced with a special mains connection cable by a qualified electrician (see “Electrical connection” in the “Installation” chapter).
- ▶ The hob must be disconnected from the mains electricity supply during installation, maintenance and repair work. Ensure that power is not supplied to the appliance until after it has been installed or until any maintenance or repair work has been carried out.
- ▶ Danger of electric shock. Do not use the hob if it is faulty, or if the ceramic surface is cracked, chipped or damaged in any way. Switch it off immediately, disconnect it from the mains electricity supply and contact your Miele dealer.
- ▶ If the hob is installed behind a cabinet door, do not close the door while the hob is in use. Heat and moisture can build up behind the closed door. This can result in damage to the hob, the housing unit and the floor. Do not close the door until the residual heat indicators go out.
- ▶ In areas which may be subject to infestation by cockroaches or other vermin, pay particular attention to keeping the appliance and its surroundings clean at all times. Any damage caused by cockroaches or other vermin will not be covered by the warranty.

Warning and Safety instructions

Correct use

- ▶ The hob gets hot when in use and remains hot for a while after being switched off. There is a danger of burning until the residual heat indicators go out.
- ▶ Due to the high temperatures radiated, objects left near the hob when it is in use could catch fire.
Do not use the hob to heat up the room.
- ▶ Oil and fat can overheat and catch fire. Do not leave the hob unattended when cooking with oil and fat. If it does ignite do not attempt to put the flames out with water.
Disconnect the hob from the mains and use a suitable fire blanket, saucepan lid, damp towel or similar to smother the flames.
- ▶ Do not leave the hob unattended whilst it is being used. It should be continually monitored whilst boiling and flash frying.
- ▶ Flames could set the grease filters of a cooker hood on fire. Do not flambé under a cooker hood.
- ▶ Spray canisters, aerosols and other inflammable substances can ignite when heated. Therefore do not store such items or substances in a drawer under the hob. Cutlery inserts must be heat-resistant.
- ▶ Do not heat an empty pan.
- ▶ Do not heat up food in closed containers e.g. tins or sealed jars on the hob, as pressure can build up in the container, causing it to explode.
- ▶ Do not cover the hob, e.g. with a hob cover, a cloth or protective foil. The material could catch fire, shatter or melt if the hob is switched on by mistake or if residual heat is still present.

Warning and Safety instructions

- ▶ When the appliance is switched on either deliberately or by mistake, or when there is residual heat present, there is the risk of any metal items left on the hob heating up, with the danger of burning. Depending on the material, other items left on the hob could also melt or catch fire. Damp pan lids might adhere to the ceramic surface and be difficult to dislodge. Do not use the appliance as a resting place. Switch the cooking zones off after use.
- ▶ You could burn yourself on the hot hob. Protect your hands with heat-resistant pot holders or gloves when handling hot pots and pans. Do not let them get wet or damp, as this causes heat to transfer through the material more quickly with the risk of scalding or burning yourself.
- ▶ When using an electrical appliance, e.g. a hand-held food blender, near the hob, ensure that the cable of the electrical appliance cannot come into contact with the hot hob. The insulation on the cable could become damaged.
- ▶ Grains of salt, sugar and sand (e.g. from cleaning vegetables) can cause scratches if they get under pan bases. Make sure that the ceramic surface is clean before placing pans on it.
- ▶ Even a light object can cause damage in certain circumstances. Do not drop anything on the ceramic surface.
- ▶ Placing hot pans on the sensors and indicators could damage the electronics underneath. Do not place hot pans on the sensors or indicators.
- ▶ Do not allow solid or liquid sugar, or pieces of plastic or aluminium foil to get onto the hob when it is hot, as they can damage the ceramic surface when it cools down. If this should occur, switch off the appliance and scrape off all the sugar, plastic or aluminium residues whilst still hot, using a shielded scraper blade suitable for use on glass. Wear oven gloves when doing this. Allow the ceramic surface to cool down and then clean it with a suitable ceramic hob cleaning agent.

Warning and Safety instructions

- ▶ Pans which boil dry can cause damage to the ceramic glass. Do not leave the hob unattended whilst it is being used.
- ▶ Only use pots and pans with smooth bases. Rough bases will scratch the ceramic glass.
- ▶ Lift pans into position on the hob. Sliding them into place can cause scuffs and scratches.
- ▶ Plastic and aluminium foil containers melt at high temperatures. Do not use plastic or aluminium foil containers on the hob.
- ▶ The hob frame or hob edges (on hobs with bevelled edges) and the controls can become hot due to the influence of the following factors: operating duration, high power level(s), large pans and the number of cooking zones being used.
- ▶ Pots and pans made of aluminium or with an aluminium base can leave a metallic sheen on the hob. This can be removed with the ceramic and stainless steel hob cleaner (see “Cleaning and care”).
- ▶ If spills remain on the hob for any length of time they can burn on and in certain circumstances become impossible to remove. Remove any soiling as quickly as possible and ensure that pan bases are clean, dry and free of grease.
- ▶ Do not use the ceramic surface for preparing food on. Always use suitable pots and pans.

Cleaning and care

- ▶ Do not use a steam cleaning appliance to clean this hob. The steam could reach electrical components and cause a short circuit.
- ▶ Miele will guarantee to supply functional spare parts for a minimum of 10 years and up to 15 years following the discontinuation of your hob.

Disposal of the packing material

The packaging is designed to protect the appliance from damage during transportation. The packaging materials used are selected from materials which are environmentally friendly for disposal and should be recycled.

Recycling the packaging reduces the use of raw materials in the manufacturing process and also reduces the amount of waste in landfill sites.

Disposal of your old appliance

Electrical and electronic appliances often contain valuable materials. They also contain materials which, if handled or disposed of incorrectly, could be potentially hazardous to human health and to the environment. They are, however, essential for the correct functioning of your appliance. Please do not therefore dispose of it with your household waste.

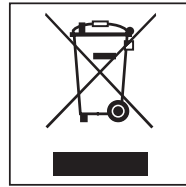

Please dispose of it at your local community waste collection / recycling centre or contact your Miele dealer for advice.

Ensure that it presents no danger to children while being stored for disposal.

Guide to the appliance

Hob

KM 6565 FR

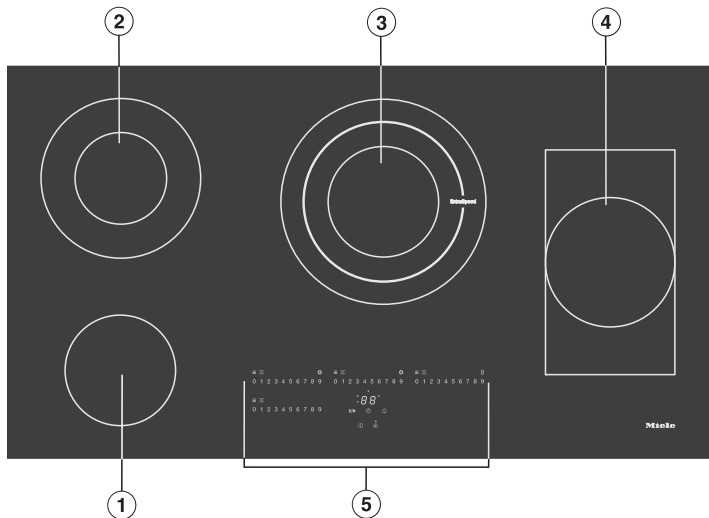

- ① Single circle zone
- ② Double circle zone
- ③ Triple circle zone with ExtraSpeed
- ④ Extended zone
- ⑤ Controls and indicators

Controls and display

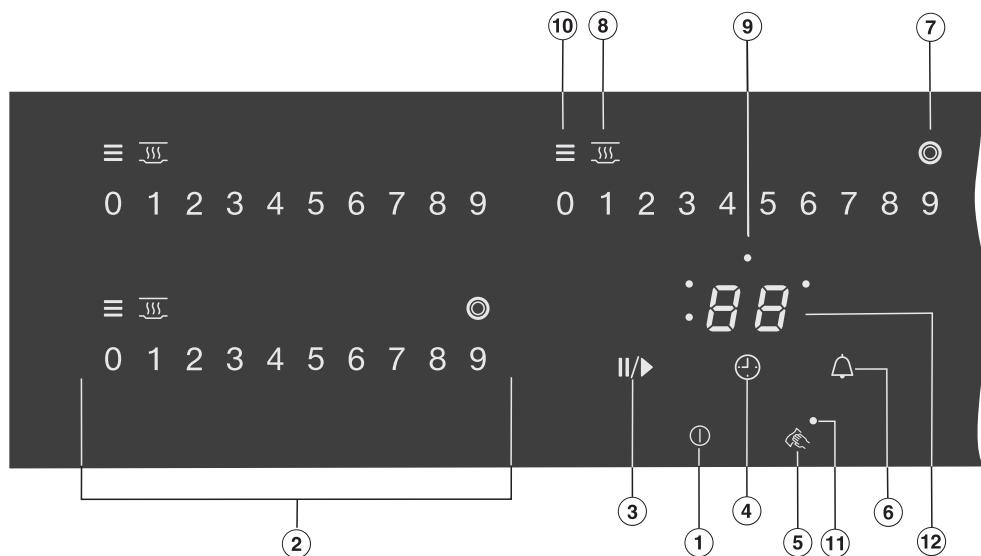

Sensor controls

- ① For switching the hob on and off
- ② Numerical keybank
 - For setting the power level
 - For setting the timer
- ③ Stop & Go
- ④ Switching off a cooking zone automatically
- ⑤ Wipe protection
- ⑥ Minute minder
- ⑦ For switching on an extended cooking zone

⑧ Keeping warm function

Displays/indicator lights

- ⑨ Automatic switch-off allocation of cooking zones
- ⑩ Residual heat
- ⑪ Wipe protection activated

Guide to the appliance

⑫ Timer display

0:00 to Time
9:59

LOC System lock/safety lock activated

dE Demonstration mode activated

Cooking zones

KM 6565 FR		
Cooking zone	Ø in cm	Rating in watts for 230 V
①	14.5	1200
②	12.0 / 21.0	750 / 2200
③	14.5 / 21.0 / 27.0	1050/2050/3200
④	17.0 / 17.0 x 29.0	1500/2600
		Total: 9200

Before using for the first time

- Please stick the extra data plate for the appliance supplied with this documentation in the space provided in the “After sales service” section of this booklet.
- Remove any protective wrapping and stickers.

Cleaning the hob for the first time

- Before using for the first time, clean the hob with a damp cloth only and then wipe dry.

Switching on the hob for the first time

The metal components have a protective coating which when heated for the first time will give off a slight smell and possibly some vapours.

The smell and any vapours given off do not indicate a faulty connection or appliance and they are not hazardous to health.

Before using for the first time

Miele@home

Requirements:

- Home WiFi network
- The WiFi stick supplied with your appliance must be fitted.

Once the WiFi stick has been fitted, the hob can be connected to the home WiFi network.

If your Miele cooker hood is also connected to the home WiFi network, you can control the cooker hood automatically with the Con@ctivity function. Further information can be found in the operating and installation instructions for your cooker hood.

Make sure that the signal of your WiFi network is sufficiently strong in the place where your hob is installed.

There are a number of ways of connecting your hob to your WiFi network.

The hob requires max. 2 W in networked standby.

Availability of the WiFi connection

The WiFi connection shares a frequency range with other appliances (including microwave ovens and remote control toys). This can give rise to sporadic or even complete connection failures. Therefore, the availability of featured functions cannot be guaranteed.

Miele@home availability

The ability to use the Miele app depends on the availability of the Miele@home service in your country.

The Miele@home service is not available in every country.

For information about availability, please visit www.miele.com.

Miele App

The Miele App is available to download free of charge from the Apple App Store® or from the Google Play Store™.



After installing the Miele app on a mobile device, you can do the following:

- Call up information on the operating status of your hob
- Call up information on the programme sequence of your hob
- Set up a Miele@home network with other WiFi-enabled Miele appliances

Before using for the first time

Setting up Miele@home

Connecting via the app

The Miele app can be used to connect to your network.

- Install the Miele app on your mobile device.

To connect, you will need:

1. Your WiFi network password
2. The password for your hob

The password for your hob consists of the last 9 digits of the serial number. This can be found on the appliance's data plate.

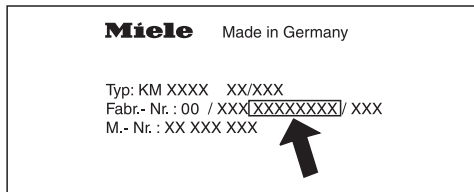

- Switch the hob on.
- Start the Miele app.
- Touch the 0 sensor control on any of the numerical displays.
- Touch the 0 and 5 sensor controls at the same time for 6 seconds.

The seconds can be seen counting down in the timer display. After the time has elapsed, the code C:07 is displayed in the timer display for 10 seconds.

You now have 10 minutes to configure the WiFi.

- Follow the user navigation in the app.

Connecting via WPS

Prerequisite: you must have a WPS (WiFi protected setup) compatible router.

- Switch the hob on.
- Touch the 0 sensor control on any of the numerical displays.
- Touch the 0 and 6 sensor controls at the same time for 6 seconds.

The seconds can be seen counting down in the timer display. After the time has elapsed, a progress light appears in the timer display during the connection attempt (for max. 120 seconds).

The WPS login is only active during these 120 seconds.

- Activate the WPS function on your WiFi router.

If the connection was successful, the code C:02 appears in the timer display. If the connection could not be established, the timer display will show the code C:07 . You have probably not activated WPS on your router quickly enough. Repeat the steps above.

Tip: If your WiFi router does not support WPS, please connect via the Miele app.

Canceling the process

- Touch any sensor control.

Resetting settings

It is not necessary to reset when replacing the wireless stick or the router.

- Switch the hob on.
- Touch the 0 sensor control on any of the numerical displays.
- Touch the 0 and 9 sensor controls at the same time for 6 seconds.

The seconds can be seen counting down in the timer display. After the 6 seconds have elapsed, the code *C:00* is displayed in the timer display for 10 seconds.

Reset the settings if you are disposing of your hob, selling it or putting a used hob into operation. This is the only way to ensure that all personal data has been removed and the previous owner will no longer be able to access the hob.

Before using for the first time

Con@ctivity

Con@ctivity is the direct communication system between your hob and a Miele cooker hood. Con@ctivity enables the cooker hood to operate automatically depending on the operating status of a hob.

Further information can be found in the operating and installation instructions for your cooker hood.

The hob requires max. 2 W in networked standby.

Availability of the WiFi connection

The WiFi connection shares a frequency range with other appliances (including microwave ovens and remote control toys). This can give rise to sporadic or even complete connection failures. Therefore, the availability of featured functions cannot be guaranteed.

Setting up Con@ctivity

Con@ctivity via the home WiFi network (Con@ctivity 3.0)

Requirements:

- Home WiFi network
- The WiFi stick supplied with your appliance must be fitted
- WiFi-enabled Miele cooker hood

- Connect the cooker hood and the hob to your home WiFi network (see "Before using for the first time – Miele@home").

The Con@ctivity function will be activated automatically.

Before using for the first time

Con@ctivity via a direct WiFi connection (Con@ctivity 3.0)

Pre-requisite:

- The WiFi stick supplied with your appliance must be fitted
- WiFi-enabled Miele cooker hood

If you do not have a home network, you can establish a direct connection between the hob and the cooker hood.

- Switch the cooker hood off.
- Press and hold the + (B*) control.
- Press the – (1*) control at the same time.

* Cooker hoods with sensor controls.

2 will light up constantly, and 3 will flash on and off.

The cooker hood will be ready for connection in the next 2 minutes.

- Switch the hob on.
- Touch the 0 sensor control on any of the numerical displays.
- Touch and hold the 0 and 7 sensor controls on the numerical display at the same time for 6 seconds.

The seconds can be seen counting down in the timer display. After the time has elapsed, a progress light appears in the timer display during the connection attempt. If the connection was successful, the code `∞:02` appears in the timer display. If the connection could not be established, the timer display will show the code `∞:01`. Repeat the steps above.

When successfully connected, 2 and 3 will light up constantly on the cooker hood.

- Quit connection mode on the cooker hood by pressing the run-on control ⁵ ¹⁵.

Con@ctivity has now been activated.

With a direct WiFi connection, it is not possible to connect the hob and the cooker hood to a home network. If this is desired later, the direct WiFi connection between the hob and the cooker hood must first be disconnected (see “Initial commissioning – Con@ctivity” and “Disconnecting the WiFi” in the operating and installation instructions for the cooker hood).

Before using for the first time

Canceling the process

- Touch any sensor control.

Resetting settings

It is not necessary to reset when replacing the wireless stick or the router.

- Switch the hob on.
- Touch the 0 sensor control on any of the numerical displays.
- Touch the 0 and 9 sensor controls at the same time for 6 seconds.

The seconds can be seen counting down in the timer display. After the 6 seconds have elapsed, the code *C:00* is displayed in the timer display for 10 seconds.

Reset the settings if you are disposing of your hob, selling it or putting a used hob into operation. This is the only way to ensure that all personal data has been removed and the previous owner will no longer be able to access the hob.

How the cooking zones work

Single circle cooking zones have one heating element, whilst double circle cooking zones and extended zones have two. Depending on the model, the heating elements may be separated by an insulating ring.

Each cooking zone has overheating protection (a temperature limiter), which stops the ceramic surface from becoming too hot (see “Overheating protection”).

When a power level is selected, heating is activated and the glowing heater element can be seen through the ceramic surface. The heater rating of the cooking zones depends on the power level selected, and is electronically regulated. The “timing” of the cooking zone is controlled by switching the element on and off.

Single circle zone

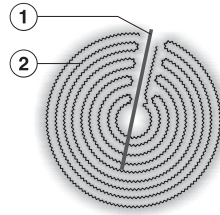

- ① Overheating protection
- ② Heating element

Double circle zone

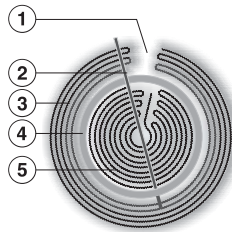

- ① Intentional gap (technical requirement)
- ② Overheating protection
- ③ Outer heating element
- ④ Isolating ring
- ⑤ Inner heating element

Pans

The best pots and pans are metal ones with a thick base which is very slightly concave when cold. When heated, the base flattens to rest evenly on the hob, optimising the conduction of the heat.

- Please note that the maximum diameter quoted by manufacturers often refers to the diameter of the top rim of the pot or pan. The diameter of the base (generally smaller) is more important.

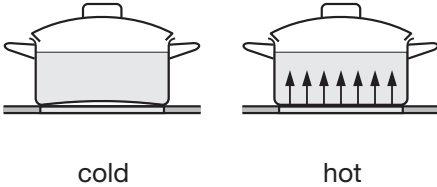

Glass, ceramic, or stoneware is **less suitable**. These materials do not conduct the heat well.

Cutlery made of synthetic material, and aluminum foil **are not suitable**. These melt at high temperatures.

Pots and pans made of aluminium or with an aluminium base can leave a metallic sheen on the hob. This can be removed with the ceramic and stainless steel hob cleaner (see “Cleaning and care”).

Please be aware that the properties of the pan base can affect the evenness with which the food heats up (e.g. when making pancakes).

- To make optimum use of the cooking zones, choose pans with a suitable base diameter (see chapter “Cooking zones”).
- Use only pots and pans with smooth bases. Rough bases can scratch the ceramic glass.
- Always lift the pans to move them. This will help prevent scratching.

Tips on saving energy

- Check that the diameter of the pan base is wide enough for the cooking zone so that heat is not lost unnecessarily.

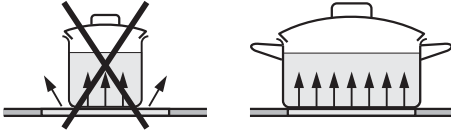

- Use a pan lid whenever possible to minimize heat loss.
- Select a smaller pan when cooking small quantities. A small pan on a small cooking zone uses less energy than a large, partially filled pan on a large cooking zone.
- Cook with as little water as possible.
- Once food has come to the boil or the oil in the pan is hot enough for frying, reduce the heat to a lower setting.
- When cooking for a long time, switch the cooking zone off about 5 to 10 minutes before the end of the cooking time. In this way, use is made of the residual heat.
- Use a pressure cooker to reduce cooking times.

Setting range

The hob is programmed with 9 power levels at the factory. If you wish to fine-tune a setting, you can extend the power level range to 17 power levels (see “Programming”).



	Setting ranges	
	Default setting (9 power levels)	Extended settings (17 power levels)
Melting butter, chocolate etc. Dissolving gelatine	1–2	1–2.
Warming small quantities of food/liquids Keeping warm food which sticks easily Cooking rice	1–3	1–3.
Warming liquid and semi-solid foods Thickening sauces, e.g. Hollandaise Making porridge Making omelettes, lightly fried eggs Steaming fruit	2–4	2–4.
Defrosting deep frozen food Steaming vegetables, fish Cooking pasta, pulses Cooking broths, pulse soups	3–6	3–5.
Bringing to the boil and continued cooking of large quantities of food	4–6	4.–5.
Gently frying meat, fish, sausages, eggs etc. (without overheating the fat).	6–7	6–7.
Cooking potato fritters, pancakes etc.	7–8	7–8.
Boiling large quantities of water Flash frying large amounts of meat Bringing to the boil	8–9*	8.–9*

These settings should only be taken as a guide. They apply to 4 normal servings. With deep pans, large quantities or when cooking without the lid, a higher setting is required. For smaller quantities, select a lower setting.

* The ExtraSpeed cooking zone works on power level 9 with extra high output.

Using the appliance

This ceramic hob is equipped with electronic sensor controls which react to finger contact. For safety reasons, in order to switch the appliance on, the On/Off  sensor needs to be touched for a little longer than the other sensors. Each time a sensor control is activated, an audible signal sounds.

When the hob is switched off, you can only see the printed symbols for the On/Off  and Wipe protection  controls. More sensors light up when the hob is switched on.

 Malfunction due to dirty and/or covered sensor controls.

If the sensor controls are dirty or covered this could cause them to fail to react, to activate a function or even to switch the appliance off automatically (see “Safety features”, “Safety switch-off”). Placing hot pans on the sensor controls/ indicators can damage the electronic unit underneath.

Keep the sensor controls and indicators clean.

Do not place anything over the sensor control or indicators.

Do not place hot pans over the sensor controls or indicators.

Operation

 Risk of fire with overheated food. Unattended food can overheat and catch alight. Do not leave the hob unattended whilst it is being used.

Switching on the hob

- Touch the ① sensor.

Other sensors will light up.

If no further entry is made, the hob will switch itself off after a few seconds for safety reasons.

Setting/changing the power level

- Place a pan on the cooking zone you want to use.
- Touch the appropriate sensor control on the respective numerical keybank for the power level you want.

Switching off a cooking zone

- To switch off a cooking zone, touch the 0 sensor for that cooking zone.
- To switch off the hob and all the cooking zones, touch the ① sensor.

Residual heat indicator

If a cooking zone is hot, the residual heat indicator will light up after it has been switched off or if it is not in use.

The bars of the residual heat indicator go out one after the other as the cooking zone cools down. The last horizontal bar only goes out when the cooking zone is safe to touch.

The residual heat indicators will flash if there is a power cut during use or while residual heat is still present or if you have opened the programming function while residual heat is still present.

 Risk of burning due to hot cooking zones.

The cooking zones will be hot after use.

Do not touch the cooking zones while the residual heat indicators are on.

Power level setting - Extended setting range

- Touch the numerical keybank in between two number sensors.

The numbers to the left and right of the interim level light up brighter than the others.

Example:

If you have set power level 7, the numbers 7 and 8 will be brighter than the other numbers.



Switching on an extended zone/outer ring

If you switch a double or triple cooking zone on, the second heating circle is always switched on automatically. The second heating circle of an extended zone and the third heating circle of a triple cooking zone must be switched on manually.

Switching the heater element off

- Touch the  or  sensor.

Switching the heater element on

- Touch the  or  sensor.
- Set the power level you want.

Operation

Auto heat-up

When Auto heat-up has been activated, the cooking zone switches on automatically at the highest setting and then switches to the continued cooking setting which you have previously selected. The heat-up time depends on which continued cooking setting has been chosen (see chart).

Activating Auto heat-up

- Touch the sensor for the continued cooking setting you want until a tone sounds and the sensor starts to flash.

The continued cooking setting will continue to flash during the heat-up time (see table).

With extended power levels (see “Programming”) and a selected interim power level, the sensors for the power levels in front of and after the interim power level will pulsate.

Changing the continued cooking setting while the cooking zone is heating up deactivates Auto heat-up.

Deactivating Auto heat-up

- Touch the sensor for the continued cooking setting.

or

- Set another power level.

Continued cooking setting*	Heat-up time [min : sec]
1	1:20
1.	2:00
2	2:45
2.	3:25
3	4:05
3.	4:45
4	5:30
4.	6:10
5	6:50
5.	7:10
6	1:20
6.	2:00
7	2:45
7.	2:45
8	2:45
8.	2:45
9	–

* The continued cooking settings with a dot after the number are only available if the power level range has been extended (see “Programming”). As the higher continued cooking settings are generally used for frying food, only a relatively short heat-up time is needed to heat up the pan initially.

Keeping warm

This function is for keeping food warm which has just been cooked and is still hot. It is not for reheating food that has gone cold.

The maximum duration for keeping food warm is 2 hours.

- Only use pans for keeping food warm. Cover the pan with a lid.
- Stir firm or viscous food (mashed potatoes, stew) occasionally.
- Nutrients are lost when food is cooked, and continue to diminish when food is kept warm. The longer food is kept warm, the greater the loss of nutrients. Try to ensure that food is kept warm for as short a time as possible.

Activating/deactivating the keeping warm function

- Touch the  sensor for the cooking zone you wish to use.

Timer

The hob has to be switched on if you wish to use the timer.

A duration of between 1 min (0:01) and 99 min (99) can be set.

After the first number has been entered, the timer display will light up constantly. After the second number has been entered, the first number will move to the left.

The timer can be used for the following 2 functions:

- For setting the minute minder (△).
- For automatically switching a cooking zone off (⊕).

The functions can be used at the same time. The shortest time is always displayed and the △ sensor control (minute minder) or the indicator light of the cooking zone for automatic switch-off flashes on and off.

Touch the △ or ⊕ sensor control if you want to show the times remaining counting down in the background. If a switch-off time has been programmed for several cooking zones, touch the ⊕ sensor control repeatedly until the indicator for the required cooking zone flashes on and off.

Minute minder

The minute minder is set using the numerical keybank for the left or front left cooking zone (depending on model).

Setting the minute minder

- Touch the △ sensor control.

The timer display starts flashing.

- Set the required time.

Changing the minute minder duration

- Touch the △ sensor control.
- Set the required time.

Deleting the minute minder duration

- Touch the △ sensor control repeatedly until 0:00 appears in the timer display.

Switching off a cooking zone automatically

You can set a time after which a cooking zone will switch off automatically. This function can be used for all cooking zones at the same time.

The switch-off time is set on the numerical display for each cooking zone you want to switch off automatically.

If the time programmed is longer than the maximum operational time allowed, the safety switch-off will switch off the cooking zone after the maximum permitted safety time has elapsed (see “Safety features – Safety switch-off”).

- Select a power level for the cooking zone you require.
- Touch the ⌚ sensor control.

The indicator light will begin to flash.

- Set the required duration.
- If you want to set another cooking zone to switch off automatically, follow the same steps as described above.

If more than one switch off time is programmed, the shortest time left will be displayed, and the corresponding indicator light will flash. All the other indicator lights will light up constantly.

- If you want to show the time left for another zone which is counting down in the background, touch the

⌚ sensor control repeatedly until the indicator light for the zone you require flashes.

Changing the switch-off time

- Touch the ⌚ sensor control repeatedly until the indicator light for the cooking zone you require flashes.
- Set the required duration.

Deleting the switch-off time

- Touch the ⌚ sensor control repeatedly until the indicator light for the cooking zone you require flashes.
- Touch the 0 sensor control on the numerical display.

Additional functions

Stop & Go

When Stop & Go is activated, the power of all cooking zones in use is reduced to power level 1.

The cooking zone power levels and the timer settings cannot be altered, the hob can only be switched off. The minute minder, switch-off times, and the AutoBoost times continue to run. When Stop&Go is deactivated, the cooking zones will operate at the power level previously selected.

If the function is not deactivated within 1 hour, the hob will switch off.

Activating/Deactivating

- Touch the II/▶ sensor control.

Recall

If the hob is switched off in error during operation, this function can be used to reset all settings. For this to work, the hob must be switched on again within 10 seconds of being switched off.

- Switch the hob on again.

The previously set power level flashes.

- Touch one of the flashing power levels immediately.

All the cooking zones and the timer will continue to operate using the settings selected previously.

Wipe protection

The hob sensors can be locked for 20 s in order, for example, to remove soiling. The ① is not locked.

Activating

- Touch the  sensor.

The time will count down in the timer display.

Deactivating

- Touch the  sensor until the timer display goes out.

Demonstration mode

This function enables the hob to be demonstrated in showrooms without heating up.

Activating / Deactivating

- Switch the hob on.
- Touch the 0 sensor control on any of the numerical keybanks.
- Then touch the 0 and 2 sensors at the same time for 6 seconds.

In the timer display, *dE* flashes alternately with *Dn* (demonstration mode activated) or *OFF* (demonstration mode deactivated) for a few seconds.

Displaying hob data

The model number and software version of the hob can be displayed. There must not be any pots or pans on the hob.

Model designation

- Switch the hob on.
- Touch the 0 sensor control on any of the numerical keybanks.
- Then touch the 0 and 4 sensor controls at the same time.

The timer display shows 2 numbers flashing alternately:

Example: *12* flashing alternately with *34*
= KM 1234

Software version

- Switch the hob on.
- Touch the 0 sensor control on any of the numerical keybanks.
- Then touch the 0 and 3 sensor controls at the same time.

Numbers appear in the timer display:

Example: *2:00* = Software version 2.00

Safety features

System lock/safety lock

Your hob is equipped with a system lock and a safety lock to prevent the hob and the cooking zones being switched on or any settings being altered by mistake.

The **system lock** is activated when the hob is switched off. If the system lock is activated, the hob cannot be switched on and the timer cannot be used. A set minute minder time continues to count down. The hob is programmed so that the system lock must be activated manually. The system lock can be programmed to be activated automatically 5 minutes after the hob has been switched off (see “Programming”).

The **safety lock** is activated when the hob is switched on. When the lock is activated, the hob can be operated only under certain conditions:

- The cooking zones and the hob can only be switched off.
- A set minute minder time can be modified.

If an unavailable sensor control is touched whilst the system lock or safety lock is activated *LL* will appear in the timer display for few seconds and a tone will sound.

Activating the system lock

- Touch the ① sensor for 6 seconds.



The seconds can be seen counting down in the timer display. When this time has elapsed *LL* will appear in the timer display. The system lock has been activated.

Deactivating the system lock

- Touch the ① sensor for 6 seconds.



LL will appear briefly in the timer display and then the seconds will be seen counting down. The system lock is deactivated once the time has elapsed.

Activating the safety lock

- Touch and hold the  and  sensors at the same time for 6 seconds.

The seconds can be seen counting down in the timer display. When this time has elapsed LL will appear in the timer display. The safety lock is activated.

Deactivating the safety lock

- Touch and hold the  and  sensors at the same time for 6 seconds.

LL will appear briefly in the timer display and then the seconds will be seen counting down. Once the time has elapsed, the lock function is deactivated.

Safety features

Safety switch-off

Safety switch-off if the sensors are covered

Your hob will switch off automatically if one or several of the sensors remain covered for longer than 10 seconds, for example, by finger contact, food boiling over or by an object such as an oven glove or tea towel. *F* will appear in the timer display for a few seconds. If the ① sensor is affected, *F* will light up until the object or soiling has been removed.

F will go out once you have removed the object or cleaned the hob and the hob will be ready to use again.

Excessive operating time

The safety switch-off mechanism is triggered automatically if a cooking zone is heated for an unusually long period of time. This time depends on the power level selected. If it has been exceeded, the cooking zone switches off and the residual heat indicator appears. If you switch the cooking zone on and off again, it is ready for operation again.

The hob is programmed to safety setting 0 at the factory. If necessary, a higher safety setting with a shorter maximum operating time can be set (see chart).

Power level*	Maximum operating time [h:min]		
	Safety setting		
	0**	1	2
1	10:00	8:00	5:00
1.	10:00	7:00	4:00
2/2.	5:00	4:00	3:00
3/3.	5:00	3:30	2:00
4/4.	4:00	2:00	1:30
5/5.	4:00	1:30	1:00
6/6.	4:00	1:00	0:30
7/7.	4:00	0:42	0:24
8	4:00	0:30	0:20
8.	4:00	0:30	0:18
9	1:00	0:24	0:10

* The power levels with a dot after the number are only available if the power level range has been extended (see "Setting range").

** Factory default setting

Overheating protection / Pan protection

Each cooking zone is equipped with overheating protection (internal temperature limiter).

The ExtraSpeed cooking zone is also equipped with a pan protection mechanism. If you wish to use this feature, you will need to alter the factory setting (see “Programming”).

If the **overheating protection** has switched on, the heating element switches on and off even when the highest power level is selected.

If the **pan protection** has been activated, the heating element for the cooking zone switches off. **S** will flash alternately with **D** on the ExtraSpeed cooking zone's numerical keybank.

The overheating protection and the pan protection switch on in the following situations:

- A pan unsuitable for use with an induction hob is being used or no pan is on the cooking zone.
- The pan being used is empty.
- The base of a pan not sitting evenly on the cooking zone.
- The pan is not conducting heat properly.

You can tell that the overheating protection has activated because the heating element switches on and off even when the highest power level is selected.

Programming

You can adapt the programming of the hob to your personal needs. Several settings can be altered in succession.

After accessing programming mode, *P* (programme) and *C* (code) will appear in the timer display. On hobs that have 3 cooking zones, an additional display appears at the back left.

The programme is displayed in the front left and rear left cooking zone numerical keybanks.

Example:

Programme 3 =

front left *3*, rear left *0*

Programme 14 =

front left *4*, rear left *1*

The status is displayed on the front right numerical keybank.

Changing the programming

Accessing programming mode

- With the hob **switched off** press both the $\text{\textcircled{1}}$ and **II/▶** sensor controls, until *P**C* appears in the timer display.

Setting the programme

For a two-digit programme number you need to first set the tens position.

- To set the **units**, touch the required number on the **front left** numerical keybank.
- To set the **tens**, touch the required number on the **rear left** numerical keybank.

Setting the code

- Touch the relevant number on the **front right** numerical keybank.

Saving the settings

- Touch the $\text{\textcircled{1}}$ sensor control until the indicators go out.

To avoid saving the settings

- Touch the **II/▶** sensor control until the indicators go out.

Programming

Programme ¹		Code ²	Settings
1	Demo mode	0	Demo mode off
		1	Demo mode on ³
3	Factory default setting	0	Do not restore factory default settings
		1	Restore factory default settings
4	Number of cooking zone power levels	0	9 power levels + Booster
		1	17 power levels + Booster ⁴
5	Pan protection with ExtraSpeed cooking zone	0	Off
		1	Not sensitive
		2	Normal
		3	Highly sensitive
6	Audible tone when a sensor control is touched	0	Off ⁵
		1	Quiet
		2	Medium
		3	Loud
7	Timer buzzer	0	Off
		1	Quiet
		2	Medium
		3	Loud
8	System lock	0	System lock can only be activated manually
		1	System lock activated automatically
9	Maximum operating time	0	Safety setting 0
		1	Safety setting 1
		2	Safety setting 2

Programming

Programme ¹		Code ²	Settings
10	WiFi registration	0	Not active/deactivated
		1	Active but not configured
		2	Active and configured (cannot be selected; displays whether connection was successful)
		3	Connection possible via WPS push button
		4	WiFi reset to default (0)
		5	Direct WiFi connection of hob and cooker hood without Miele app (Con@ctivity 3.0)
12	Sensor controls reaction speed	0	Slow
		1	Normal
		2	Fast

¹ Unlisted programmes are not assigned.

² The factory-set code is shown in bold.

³ After the hob has been switched on *dE* appears in the timer display for a few seconds.

⁴ In the text and charts, the extended power levels are shown with a dot after the number for better understanding.

⁵ The audible tone for the On/Off sensor control cannot be switched off.



Risk of burning due to hot cooking zones.

The cooking zones will be hot after use.

Switch the hob off.

Allow the cooking zones to cool down before cleaning the hob.



Risk of damage due to moisture ingress.

The steam from a steam cleaning appliance could reach live electrical components and cause a short circuit.

Do not use a steam cleaner to clean the hob.

All surfaces could be discoloured or damaged if unsuitable cleaning agents are used. All surfaces are susceptible to scratching.

Remove all cleaning agent residues immediately.

Never use abrasive sponges or cleaning agents.

- Clean the hob after every use.
- Dry the hob thoroughly after cleaning with water to avoid limescale residue.

Unsuitable cleaning agents

To avoid damaging the surfaces of the appliance, do not use:

- washing-up liquid
- cleaning agents containing soda, alkalines, ammonia, acids or chlorides
- cleaning agents containing descaling agents
- stain and rust removers
- abrasive cleaning agents, e.g. powder cleaners and cream cleaners
- solvent-based cleaning agents
- dishwasher cleaner
- oven sprays
- glass cleaning agents
- hard, abrasive brushes or sponges (e.g. pot scourers) or sponges which have been previously used and still contain abrasive cleaning agents
- melamine eraser blocks

Cleaning and care

Cleaning the ceramic surface

 Risk of damage by pointed objects.

The seal between the hob and the worktop could suffer damage.

The seal between the ceramic surface and the frame could suffer damage.

Do not use pointed objects for cleaning.

Not all soiling and residues can be removed using a solution of washing-up liquid. An invisible film can develop that can lead to discolouration of the glass ceramic surface. This discolouration cannot be removed.

Clean the ceramic surface regularly with a proprietary ceramic glass cleaning agent.

- Remove any coarse soiling with a damp cloth and more stubborn soiling with a shielded scraper blade suitable for use on glass.
- Then clean the ceramic glass surface with the Miele ceramic and stainless steel hob cleaner (see “optional accessories”) or with a proprietary ceramic glass cleaner applied with kitchen paper or a clean cloth. Do not apply the cleaner while the hob is still hot, as this can result in marking. Please follow the cleaning agent manufacturer's instructions.
- Finally wipe the glass ceramic surface with a damp cloth and polish with a soft, dry cloth.

Residues can burn onto the hob the next time it is used and cause damage to the glass ceramic surface. Ensure that all cleaning agent residues are removed.

- **Spots** caused by limescale, water and aluminium residues (spots with a metallic appearance) can be removed using Miele's ceramic and stainless steel hob cleaner.

 Risk of burning due to hot cooking zones.

The cooking zones are hot during use.

Wear oven gloves when removing residues of sugar, plastic or aluminium foil from a hot ceramic surface with a shielded scraper blade.

- Should any **sugar, plastic or aluminium foil** spill or fall onto the hot ceramic surface while it is in use, switch off the cooking zone.
- Then carefully scrape off these residues **immediately** whilst they are still hot, using a scraper blade suitable for use on glass.
- Afterwards, clean the ceramic surface in its cooled state, as described above.

Problem solving guide

Many malfunctions and faults that can occur in daily operation can be easily remedied. Time and money will be saved because a service call will not be needed.



The following guide may help you to find the reason for a malfunction or a fault, and to correct it.

Issue	Cause and remedy
<p>The hob or cooking zones will not switch on.</p>	<p>There is no power to the hob.</p> <ul style="list-style-type: none"> ■ Check if the mains fuse has tripped. Contact a qualified electrician or your Miele dealer (for the minimum fuse rating, see data plate). <p>There may be a technical fault.</p> <ul style="list-style-type: none"> ■ Disconnect the appliance from the electricity supply for approx. 1 minute by <ul style="list-style-type: none"> – tripping the relevant mains fuse or screwing the fuse out completely, or – switching off at the residual current device. ■ If, after resetting the trip switch in the mains fuse box or the residual current device, the appliance will still not turn on, contact a qualified electrician or your Miele dealer.
<p>A smell and vapours are given off when the new appliance is being used.</p>	<p>The metal components have a protective coating which when heated for the first time will give off a slight smell and possibly some vapours. The smell and any vapours given off do not indicate a faulty connection or appliance and they are not harmful to health.</p>
<p>After the hob has been switched on <i>LL</i> appears in the timer display for a few seconds.</p>	<p>The system lock or safety lock is activated.</p> <ul style="list-style-type: none"> ■ Deactivate the system lock or safety lock (see “System lock / Safety lock”).
<p><i>F</i> flashes in the timer display and the hob switches off automatically.</p>	<p>One or more of the sensor controls are covered, e.g. by finger contact, food boiling over or an object.</p> <ul style="list-style-type: none"> ■ Clean off any dirt and/or remove the object (see “Safety switch-off”).

Problem solving guide

Issue	Cause and remedy
<p>After the hob has been switched on, dE appears briefly in the timer display. The cooking zones do not heat up.</p>	<p>The hob is in demonstration mode.</p> <ul style="list-style-type: none"> ■ Touch the 0 sensor control on any of the numerical displays. ■ Then touch the \bar{U} and \bar{L} sensor controls at the same time until dE flashes alternately with OFF in the timer display.
<p>A cooking zone switches off automatically.</p>	<p>It has been operated for too long.</p> <ul style="list-style-type: none"> ■ You can use the cooking zone again by switching it back on (see “Safety switch-off”).
<p>The food in the pan does not heat up when the Auto heat-up function is switched on.</p>	<p>A large amount of food is being heated up.</p> <ul style="list-style-type: none"> ■ Start cooking at the highest power level and then turn down to a lower one manually later on.
	<p>The pan is not conducting heat properly.</p> <ul style="list-style-type: none"> ■ Use a different pot or pan which conducts heat properly.
<p>The food in the pan is barely heating up or is not heating up at all.</p>	<p>The pan is not conducting heat properly.</p> <ul style="list-style-type: none"> ■ Use a different pot or pan which conducts heat properly.
	<p>The pan is too large for the cooking zone.</p> <ul style="list-style-type: none"> ■ Use a smaller pan.
	<p>The outer ring of a double or extended cooking zone is not switched on.</p> <ul style="list-style-type: none"> ■ Switch the outer ring on.
<p>The heating element for one of the cooking zones switches on and off.</p>	<p>This “timing” of the element is normal. It is caused by the electronic temperature control (see “How the cooking zones work”).</p> <p>If the heating switches on and off at the highest power level, the overheating protection has been triggered (see “Overheating protection”).</p>
<p>One or more residual heat indicators are flashing.</p>	<p>There was an interruption to the power supply during operation or when residual heat was present.</p>

Problem solving guide

Issue	Cause and remedy
The “” symbol flashes and “” flashes alternately with “” in the numerical keybank for the ExtraSpeed cooking zone.	Pan protection has been triggered. <ul style="list-style-type: none">■ Select a power level in order to use the cooking zone.
The sensors show increased sensitivity or fail to react.	The sensitivity level of the sensors has changed. <ul style="list-style-type: none">■ Make sure that there is no direct light (from the sun or from an artificial source) falling onto the hob. The area surrounding the hob must not be too dark.■ Make sure that there is nothing covering the sensors or the hob. Take any pans off the hob and wipe away any food deposits.■ Interrupt the power supply to the hob for approx. 1 minute.■ If the problem persists after power has been restored, please contact your Miele dealer.

Optional accessories

Miele offer a comprehensive range of useful accessories as well as cleaning and conditioning products for your Miele appliances.

These can be ordered from your Miele dealer (see end of this booklet for contact details).

Cleaning and care products

Ceramic and stainless steel hob cleaner 250 ml



Removes heavy soiling, limescale deposits and aluminium residues

Microfibre cloth

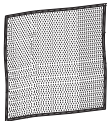

Removes finger marks and light soiling

Contact in case of malfunction

In the event of any faults which you cannot remedy yourself, please contact your Miele dealer.

Contact details for your Miele dealer are given at the end of this document.

Please note that telephone calls may be monitored and recorded for training purposes and that a call-out charge will be applied to service visits where the problem could have been resolved as described in this booklet.

Please quote the model and serial number of your appliance when contacting your Miele dealer. This information can be found on the data plate.

Data plate

Stick the extra data plate supplied with the appliance here. Make sure that the model number matches the one specified on the back cover of this document.





Guarantee

For information on the appliance guarantee specific to your country please contact your Miele dealer. See end of this booklet for contact details.

Installation

Safety instructions for installation

 **Damage risk from incorrect installation.**
Incorrect installation can cause damage to the hob.
The hob must only be installed by a qualified person.

 **Risk of electric shock.**
Incorrect connection to the mains supply may result in an electric shock.
The hob must be connected to the electrical supply by a qualified person only.

 **Damage from falling objects.**
Take care not to damage the hob when fitting wall units or a cooker hood above it.
Fit the wall units and the cooker hood before the hob.

- ▶ The veneer or laminate coatings of worktops (or adjacent kitchen units) must be treated with 100 °C heat-resistant adhesive which will not dissolve or distort. Any backmoulds must be of heat-resistant material.
- ▶ The hob must not be installed over a fridge, fridge-freezer, freezer, dishwasher, washing machine, washer-dryer or tumble dryer.
- ▶ After installation, ensure that nothing can come into contact with the connection cable and that it is without hindrance.
- ▶ The electrical cable may not come into contact with any moving kitchen component (e.g. a drawer) or be subject to mechanical obstruction which could damage it.
- ▶ Observe carefully the safety clearances listed on the following pages.

Safety distances

Safety distance above the hob

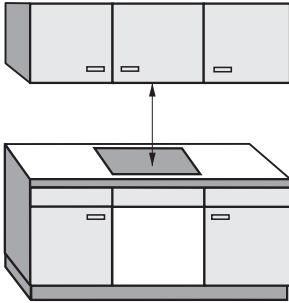

The safety distance specified by the manufacturer of the cooker hood must be maintained between the hob and the cooker hood above it.

If combustible objects are installed above the hob (e.g., cabinets, utensil rail, etc.), a minimum safety distance of 600 mm must be maintained.

When two or more appliances which have different safety distances are installed together below a cooker hood, you should observe the greatest specified safety distance.

Installation

Safety distances to the sides and back of the appliance

It is advisable to install the hob with plenty of space either side of it.

The minimum distance ① shown below must be maintained between the back of the hob and a tall unit or wall.

The minimum distance ②, ③ shown below must be maintained between a tall unit or a wall to the left or right of the hob with a minimum distance of 300 mm on the opposite side.

① Minimum distance between the **back** of the worktop cut-out and the rear edge of the worktop:
50 mm

② Minimum distance between the worktop cut-out and a wall or tall unit to the **right** of it:
50 mm.

③ Minimum distance between the worktop cut-out and a wall or tall unit to the **left** of it:
50 mm.

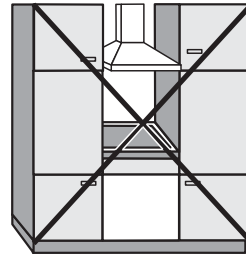

Not allowed

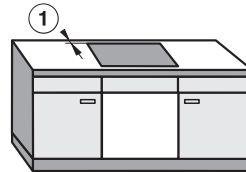
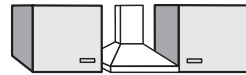

Highly recommended

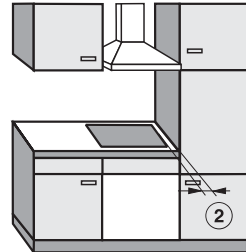

Not recommended

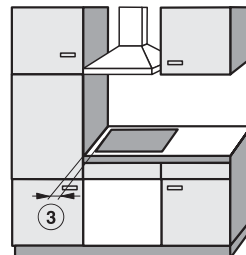

Not recommended

Interim shelf

It is not necessary to fit an interim shelf underneath the hob but one may be fitted if you wish.

If an interim shelf is fitted under the hob, there must be a minimum gap of 110 mm between the top of the worktop and the top of the shelf.

A gap of 10 mm should be left at the back of the shelf to accommodate the cable. For hobs with an external mains connection box, this gap must be at least 30 mm.

Installation

Safety distance when installing the appliance near a wall with additional niche cladding

A minimum safety distance must be maintained between the worktop cut-out and any niche cladding to protect it from heat damage.

If the niche cladding is made from a combustible material (e.g. wood) a minimum safety distance ⑤ of 50 mm must be maintained between the cut-out and the cladding.

If the niche cladding is made from a non-combustible material (e.g. metal, natural stone, ceramic tiles) the minimum safety distance ⑤ between the cut-out and the cladding will be 50 mm less the thickness of the cladding.

Example: 15 mm niche cladding

50 mm - 15 mm = minimum safety distance of 35 mm

Flush-fitted hobs

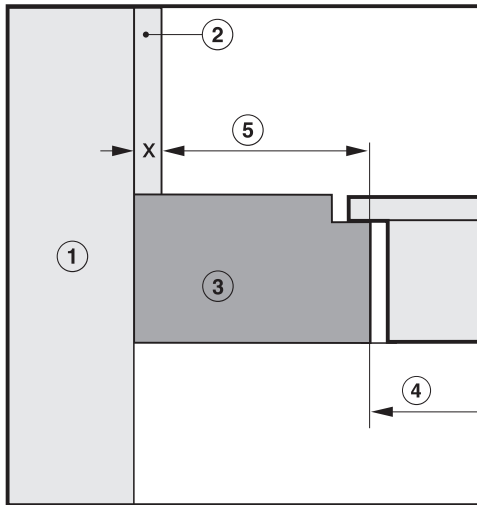

Hob with frame or bevelled edge

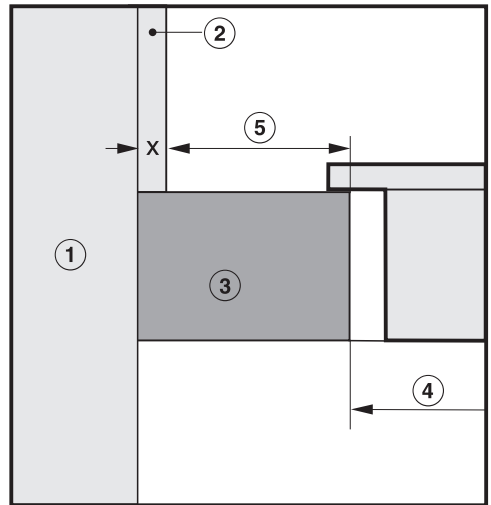

- ① Masonry
- ② Niche cladding dimension x = thickness of the niche cladding material
- ③ Worktop
- ④ Worktop cut-out
- ⑤ Minimum distance to
 - combustible** materials 50 mm
 - non-combustible** materials 50 mm - dimension x

Installation notes

Seal between the hob and the worktop

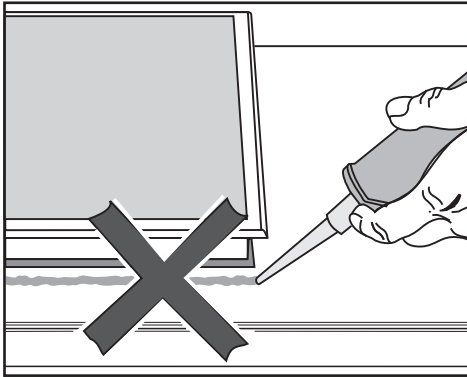

 Damage caused by incorrect installation.

Using sealant under the hob could result in damage to the hob and the worktop if the hob ever needs to be removed for servicing.

Do not use sealant between the hob and the worktop.

The sealing strip under the edge of the hob provides a sufficient seal for the worktop.

Sealing strip

Dismantling the hob for service purposes may damage the sealing strip underneath the edge of the hob.

Always replace the sealing strip before reinstalling the hob.

Tiled worktops

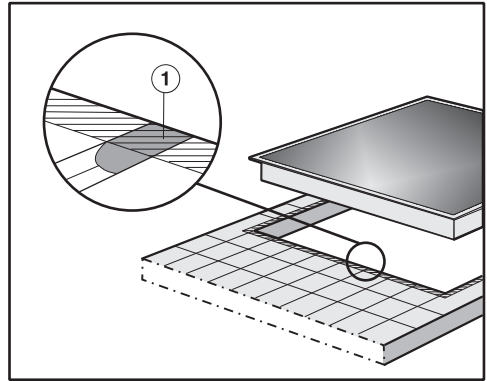

Grout lines ① and the hatched area underneath the hob frame must be smooth and even. If they are not the hob will not sit flush with the worktop and the sealing strip underneath the hob will not provide a good seal between the hob and the worktop.

Installation

Building-in dimensions

All dimensions are given in mm.

KM 6565 FR

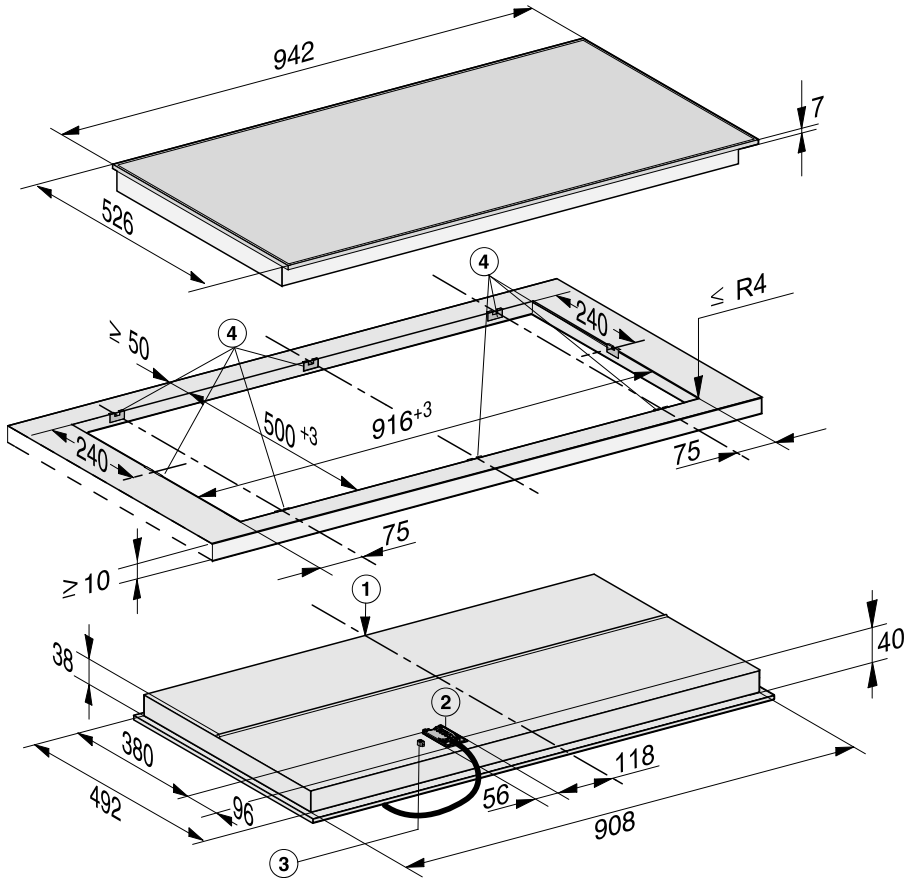

- ① Front
- ② Mains connection box with mains connection cable
Mains connection cable L = 1.440 mm
- ③ WiFi stick connection
- ④ Spring clamps

Installation

Preparing the worktop

- Create the worktop cut-out.
Remember to maintain the minimum safety distances (see “Installation – Safety distances”).

Wooden worktops

- Seal any cut surfaces on wooden worktops with a special varnish, silicone sealant or resin to prevent the wood from swelling as a result of moisture ingress. The sealant must be heat-resistant.

Make sure that the sealant does not come into contact with the top of the worktop.

The seal under the appliance ensures that the hob will sit securely in the cut-out without slipping. Any gap between the appliance frame and worktop will become smaller over time.

Secure the spring clamps

The exact positioning of the spring clamps is shown in the individual hob diagrams.

Wooden worktops

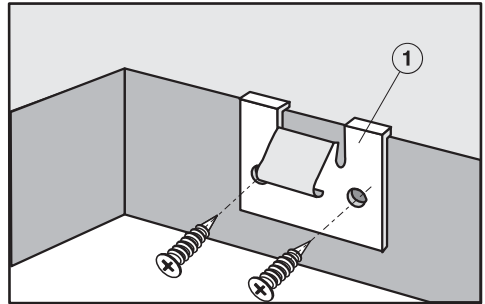

- Position the spring clamps ① on the top edge of the cut-out as shown in the hob illustration.
- Fasten the spring clamps ① using the 3.5 x 25 mm wood screws supplied with the appliance.

Installation

Natural stone worktops

You will need heavy duty double-sided adhesive tape (not included with the hob) to fasten the spring clamps.

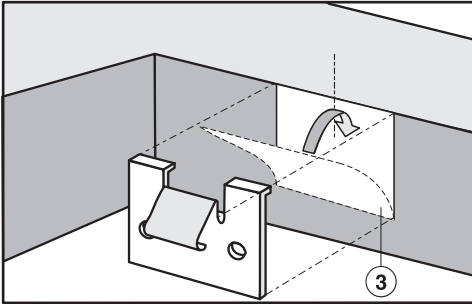

- Attach the adhesive tape ③ along the top edge of the cut-out in the positions shown in the hob illustration.
- Position the spring clamps on the top edge of the cut-out and press them firmly into place.

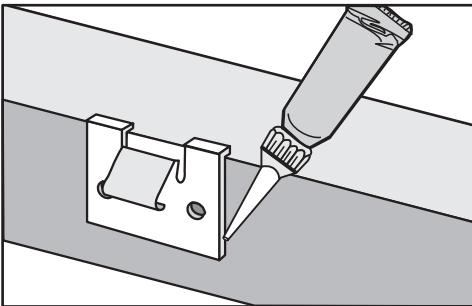

- Coat the side edges and the lower edges of the spring clamps with silicone.

Install the hob

- Feed the mains connection cable for the hob down through the worktop cut-out.
- Position the hob in the worktop cut-out.
- Using both hands, press down evenly on the sides of the hob until it clicks into position. When doing this make sure that the seal of the appliance sits flush with the worktop on all sides. This is important to ensure an effective seal all round.

If the seal does not meet the worktop correctly on the corners, the corner radius ($\leq R4$) can be carefully scribed to suit.

Do not use any additional sealant (e.g. silicone) on the hob.

- Connect the hob to the mains.
- Check that the hob works.

The hob can only be removed using a special tool.

Electrical connection

 Risk of damage from incorrect connection.

Unauthorised installation, maintenance and repairs can cause considerable danger for the user.

Miele cannot be held liable for damage or injury caused by unauthorised installation, maintenance or repair work, or by an inadequate or faulty on-site earthing system (e.g. electric shock).

This hob must be connected to the electrical supply by a qualified electrician.

The electrician must be familiar with and comply with the national regulations and any additional regulations of the local electricity provider.

After installation, ensure that all electrical components are shielded and cannot be accessed by users.

Total power rating

See data plate

Connection data

The connection data is quoted on the data plate. Please ensure these match the household mains supply.

Please see wiring diagrams for connection.

Disconnecting devices

It must be possible to disconnect the hob from the mains at all poles using disconnecting devices. A contact distance of at least 3 mm must be observed in the switched-off state. The disconnecting devices are overcurrent protection devices and residual current protection devices.

Disconnecting from the mains

 Risk of electric shock.

There is a risk of electric shock if the appliance is connected to the mains supply during repair or service work. After disconnection, ensure the appliance cannot be switched back on by mistake.

To disconnect the appliance from the mains power supply, do one of the following depending on installation:

Safety fuses

- Completely remove fuses.

Automatic circuit breakers

- Press the (red) test button until the middle (black) button springs out.

Installation

Built-in circuit breakers

- Circuit breakers at least type B or C:
Switch the lever from 1 (on) to 0 (off).

Residual current device (RCD)

- Switch the main switch from 1 (on) to 0 (off) or press the test button.

Mains connection cable

The hob must be connected to the electrical supply with a special connection cable, type H 05 VV-F (PVC insulated) with a suitable diameter.

Please see wiring diagram for connection.

See the data plate on the hob for the correct voltage and frequency.

Replacing the mains connection cable



Risk of electric shock.

Incorrect connection to the power supply may result in an electric shock.

The mains cable must only be replaced by a qualified electrician.

When replacing the mains cable only use cable type H 05 VV-F with a suitable cross section. A suitable connection cable is available from your Miele dealer.

Wiring diagram

Some connection methods are not permitted in all installation locations. Ensure compliance with national regulations and any additional regulations issued by the local electricity provider.

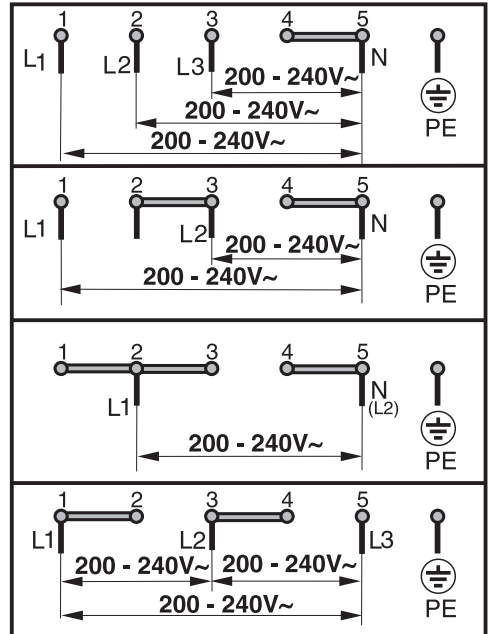

Miele Saudi Arabia

AWAD BADI NAHAS TRADING CO. LTD

Head Office:

Jeddah

P.O. Box 11529 Jeddah 21463

Tel. +966 12 2560888, Fax. +966 12 2560555

Hotline for customer care: 920003240

Website: www.awadnahas.com

Branches:

Jeddah

Madina Road

Tel. +966 12 6970060, Fax. +966 12 6970012

Jeddah

Sitteen Street

Tel. +966 12 6611675, Fax. +966 12 6606852

Jeddah

Miele Gallery

Al Thanyyan Group Building, Al-Madina Road,

Near, Al Rowdah District, Jeddah

Tel. +966 12 6989339 Ext. 100

Fax. +966 12 6989339 Ext. 200

Riyadh

Olaya Street

Tel. +966 11 2013501, Fax. +966 11 2013502

Taif

Hadiya Street

Tel. +966 12 7327001, Fax. +966 12 7369596

Khobar

Al Zahran Road

Tel. +966 13 8646150, Fax. +966 13 8646190

Miele United Arab Emirates

Miele Appliances Ltd.

Showroom 1

Eiffel 1 Building

Sheikh Zayed Road, Umm Al Sheif

P.O. Box 114782 - Dubai

United Arab Emirates

Tel. +971 4 3044 999

Fax. +971 4 3418 852

800-MIELE (64353)

E-Mail: info@miele.ae

Website: www.miele.ae

Webshop: shop.miele.ae

Manufacturer: Miele & Cie. KG, Carl-Miele-Straße 29, 33332 Gütersloh, Germany



KM 6565 FR

en-AE, SA

M.-Nr. 11 004 250 / 02