

Operating instructions Steam ironing system

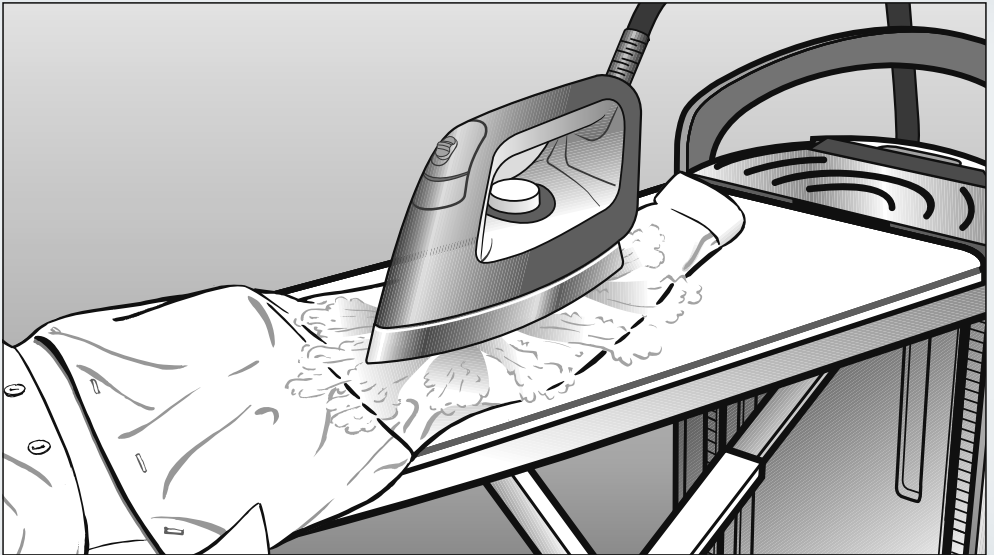

To avoid the risk of accidents or damage to the appliance, it is **essential** to read these instructions before it is installed and used for the first time.

Caring for the environment

Disposal of the packing material

The transport and protective packaging has been selected from materials which are environmentally friendly for disposal, and can normally be recycled.

Recycling the packaging reduces the use of raw materials in the manufacturing process and also reduces the amount of waste in landfill sites. Ensure that any plastic wrappings, bags etc. are disposed of safely and kept out of the reach of babies and young children. Danger of suffocation.

Disposing of your old appliance

Electrical and electronic appliances often contain valuable materials. They also contain specific materials, compounds and components, which were essential for their correct function and safety. These could be hazardous to human health and to the environment if disposed of with your domestic waste or if handled incorrectly. Please do not, therefore, dispose of your old appliance with your household waste.



Please dispose of it at your local community waste collection / recycling centre for electrical and electronic appliances. You are also responsible for deleting any personal data that may be stored on the appliance prior to disposal. Please ensure that your old appliance poses no risk to children while being stored prior to disposal.

Caring for the environment	2
Warning and Safety instructions	6
Guide to the appliance	14
Transporting the appliance	17
Assembling	18
Adjusting the height	19
Connecting	21
Connecting the mains connection cable.....	21
Removing the iron and the steam hose holder	22
Connecting the steam hose	22
Before using for the first time	24
Determining water hardness	24
Using the test strips	24
Before using for the first time.....	25
Switching on the steam ironing system	25
Language settings.....	25
Setting the water hardness	26
Set-up is now complete	27
Switching on	28
Switching on the steam ironing system	28
Filling the water container	29
Removing the water container	29
Filling the water container	29
Steam operation	30
Water quality	30
Selecting the ironing temperature	31
CoolDown function.....	33
AutoOff function	33
Ironing	34
Iron	34
Ironing with steam	35
Ironing without steam.....	36
Ironing with the non-stick soleplate	36
Attaching the non-stick soleplate.....	36
Removing the non-stick soleplate.....	37

Contents

Active ironing board	37
Suction function	37
Inflation function.....	37
Automatic switch on/off	37
Memory function	38
Heated ironing surface	38
Steamer	39
Connecting the steamer	39
Using the steamer	41
Brush attachment.....	42
Connecting the brush attachment.....	42
Removing the brush attachment.....	42
Switching off	43
Dismantling	44
Setting the ironing board to its lowest working height.....	44
Folding the ironing board	45
Disconnecting the steam hose.....	46
Storing the iron.....	46
Storing the steamer.....	46
Emptying the water container	47
Storing the steam ironing system.....	47
Cleaning and care	48
Automatic rinsing	48
Preparing for the rinsing process	48
Emptying the residual water drawer.....	48
Descaling.....	49
Descaling warning	50
Starting the descaling process early	51
Descaling process.....	51
Cleaning the housing.....	58
Cleaning the soleplate of the iron.....	58
Cleaning or replacing the ironing board cover	59

Cleaning the water filter.....	60
Disconnect the power supply.....	60
Removing the water container	60
Removing the water filter cover.....	61
Removing the sealing ring.....	61
Pulling out the water filter.....	62
Cleaning the water filter.....	62
Inserting the water filter.....	63
Inserting the water container.....	64
Optional accessories	65
Care products.....	65
Descaling tablets.....	65
Problem solving guide	66
Problem solving guide.....	67
Display messages	73
After sales service.....	77
Warranty	77
Electrical connection	78
Technical data.....	79

Warning and Safety instructions

 This steam ironing system complies with current safety requirements. Inappropriate use can, however, lead to personal injury and damage to property.

To avoid the risk of accidents and damage to the steam ironing system, please read these instructions carefully before using it for the first time. They contain important information on its safety, installation, use and maintenance.

Keep these instructions in a safe place and ensure that new users are familiar with the content. Pass them on to any future owner.

Correct application

- ▶ This steam ironing system is designed for domestic use and for use in similar environments by guests in hotel or motel rooms, bed & breakfasts and other typical living quarters. This does not include common/shared facilities or commercial facilities within hotels, motels or bed & breakfasts.
- ▶ The steam ironing system must only be used for ironing textiles which are suitable for ironing according to the care label.
- ▶ The steam ironing system is intended to be used only as described in these operating instructions.
Any other use is not permitted. Miele cannot be held liable for damage resulting from incorrect or improper use or operation.
- ▶ This steam ironing system is not intended for use by persons (including children) with reduced physical, sensory or mental capabilities, or lack of experience and knowledge, unless they have been given supervision or instruction concerning its use by a person responsible for their safety.
- ▶ This steam ironing system is not suitable for outdoor use.

Safety with children

- ▶ Young children must be kept away from the steam ironing system.
- ▶ Older children may only use the steam ironing system when its operation has been clearly explained to them and they are able to use it safely, recognising the dangers of misuse.
- ▶ Cleaning work may only be carried out by older children under the supervision of an adult.
- ▶ Please supervise children in the vicinity of the steam ironing system and do not let them play with it.
- ▶ Make sure that young children cannot access the steam hose or the power cable, either during use or while the steam ironing system is cooling down.

Miele recommends that only children over the age of 14 are allowed to operate the steam ironing system unsupervised.

▶ Risk of suffocation!

Children may be able to wrap themselves in packing material or pull it over their heads with the risk of suffocation. Keep children away from any packing material.

Warning and Safety instructions

Technical safety

▶ Before setting up the steam ironing system, inspect it visually for any external damage. Never use a damaged steam ironing system. A damaged steam ironing system can be dangerous.

▶ Check the iron of the steam ironing system for damage. Do not use the iron if it has been dropped, if there is any visible damage or if it is leaking.

▶ Before connecting the steam ironing system to the mains electricity supply, make sure that the connection data on the data plate (voltage and frequency) matches the mains electricity supply.

Connection to a supply voltage other than the one quoted on the data plate can lead to functional faults and damage to the steam ironing system. If in doubt, contact a suitably qualified electrician.

▶ Always remove and unwind the mains connection cable of the steam ironing system completely from its (lower) storage compartment.

▶ If the mains connection cable is damaged, it must be replaced with a special cable of the same type (available from Miele). For safety reasons, this must only be fitted by a Miele service technician.

▶ Do not use the steam ironing system if the ironing board cover is damaged.

A damaged ironing board cover could be dangerous.

Do not use the steam ironing system without an ironing board cover.

The ironing board cover must be replaced with an original Miele cover.

Warning and Safety instructions

- ▶ The electrical safety of this steam ironing system can only be guaranteed when continuity is complete between it and an effective earthing system which complies with current local and national safety regulations. It is most important that this basic safety requirement is present and regularly tested and, where there is any doubt, the household wiring system should be inspected by a qualified electrician. Miele cannot be held liable for the consequences of an inadequate earthing system (e.g. electric shock).
- ▶ Do not connect the steam ironing system to the mains electricity supply via a multi-socket unit or an extension lead. These do not guarantee the required safety of the appliance (e.g. danger of overheating).
- ▶ This steam ironing system complies with all relevant safety requirements. Unauthorised repairs could result in unforeseen dangers for the user, for which the manufacturer cannot accept liability. Repairs must only be undertaken by a Miele authorised service technician, otherwise any subsequent damage will not be covered by the warranty.
- ▶ Faulty components must only be replaced by genuine Miele original spare parts. Only when these parts are fitted can Miele guarantee the safety standards of the appliance.

Warning and Safety instructions

- ▶ The steam ironing system must be isolated from the electricity supply during installation, maintenance and repair work. The steam ironing system is only considered disconnected from the power supply if:
 - the power plug of the steam ironing system is switched off at the wall socket and unplugged, or
 - it is switched off at the mains circuit breaker.
- ▶ Do not damage, remove or bypass the safety features and control elements of the steam ironing system.
- ▶ Only operate the steam ironing system when all removable outer panels are in place so that it is impossible to touch an electrical component or moving part.
- ▶ The steam ironing system must not be operated in mobile installations (e.g. on a ship).

Correct use

 Emitted steam, the iron soleplate together with the areas surrounding it on the iron, and the steamer jets are very hot.

Danger of burning!

Avoid direct contact.

- ▶ The steam ironing system is not designed for commercial purposes.
- ▶ Do not use a pressure washer or water hose to clean the steam ironing system.
- ▶ Clean the steam ironing system only after it has cooled down.
- ▶ Danger of injury by crushing! Do not reach between moving parts when assembling, dismantling or adjusting the height of the steam ironing system.
- ▶ The steam ironing system must only be set up on a level surface which has the appropriate load-bearing capacity. The steam ironing system must only be used in a horizontal position.
- ▶ The steam ironing system must be assembled when ironing. However, the steamer can be used when the ironing board is in the upright position.
- ▶ Ensure that the power cable does not present a tripping hazard when unwound.
- ▶ Use caution when the appliance is heated. There is an acute risk of burning if you come in contact with the soleplate of the iron or the steamer jets. The warning symbol “Hot surface” () on the iron indicates that it is hot.
- ▶ **Do not** use solely demineralised water (e.g. distilled, battery water) to fill the water container. This could cause the steam ironing system to malfunction.

Warning and Safety instructions

- ▶ Always place the iron with its soleplate horizontally on the resting surface of the steam ironing system. Ensure the steam function is switched off and the soleplate does not protrude over the edges. Do not place the iron anywhere else as this presents a fire hazard.
- ▶ Danger of burning! If the iron remains on the resting surface for a long period of time, the surface will become hot. Avoid direct contact with the resting surface.
- ▶ Danger of burning! Never direct the steam or the steam jets of the iron or steamer at people, animals or electrical appliances of any kind.
- ▶ Danger of burning! Never point the steam at clothing while the clothes are being worn! The clothing will intensify burning of the skin.
- ▶ Switch off the steam ironing system before disconnecting the mains connection cable.
- ▶ Switch off at the wall socket and withdraw the plug from the socket. Always pull by the plug to withdraw the plug from the socket.
- ▶ Do not leave the steam ironing system unattended when it is ready for use. Before you leave the steam ironing system, disconnect the steam ironing system from the mains and withdraw the plug from the mains socket.
- ▶ Do not touch the mains connection cable or the steam hose with the soleplate of the heated iron as this could result in damage.
- ▶ While descaling the system, the iron or the steamer must not be connected to the steam ironing system. The steam ironing system can be left unattended during this process.
- ▶ The iron must not be stowed in its storage compartment when it is **connected**. This could result in damage to the steam ironing system.
- ▶ Do not use the residual water drawer to store accessories or similar items. The residual water drawer should be used only to collect residual water.

Warning and Safety instructions

- ▶ Do not insert any objects into the apertures on the steam ironing system. If an aperture is blocked, do not use the system.
- ▶ Do not hang items of laundry on the folded steam ironing system. This may cause the steam ironing system to tip over due to the effect of leverage.
- ▶ Avoid ironing across hard or sharp-edged items. These can leave marks on the soleplate.
- ▶ Do not store the steam ironing system near petrol, paraffin or other highly flammable substances. Risk of fire and explosion!
- ▶ Only use the steam ironing system inside buildings where the ambient temperature is between 10 °C and 40 °C.

Freezing temperatures, excessive heat and humidity will adversely affect the functionality of the steam ironing system.

- ▶ Do not store the steam ironing system in a room where there is a risk of frost occurring. Frozen water in the water container, steam generator or steam hose will cause damage to the appliance.

Using accessories

- ▶ Only use genuine Miele spare parts and accessories with this appliance. If spare parts or accessories from other manufacturers are used, this will invalidate the warranty, and Miele cannot accept liability.

Guide to the appliance

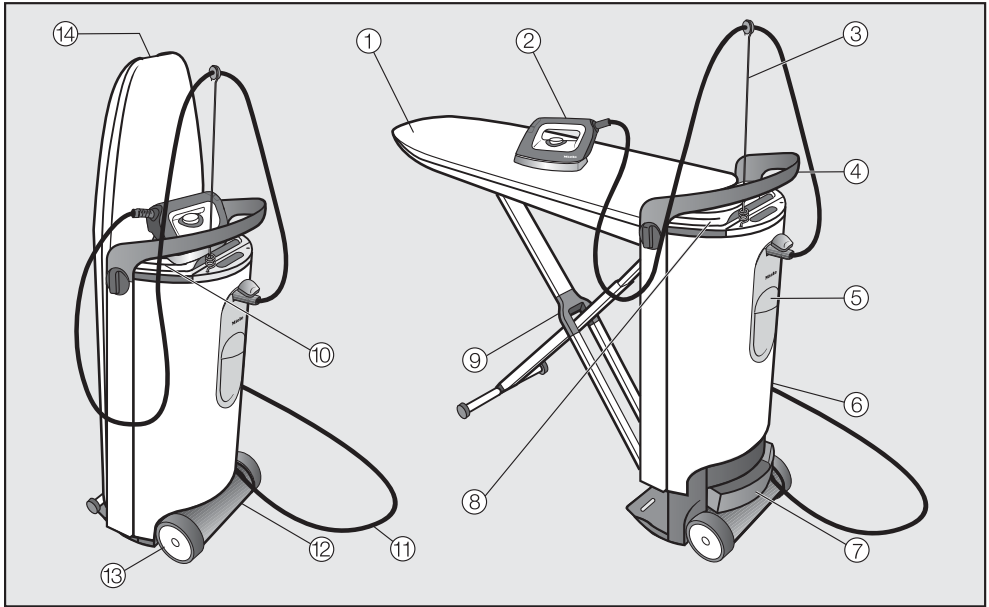

- ① Ironing board
- ② Iron with steam hose
- ③ Steam hose holder
- ④ Handle
- ⑤ Water container
- ⑥ Tower
- ⑦ Residual water drawer
- ⑧ Top storage compartment
For the iron and the steam hose holder.
- ⑨ Ironing board X-frame
- ⑩ Iron resting area
- ⑪ Mains connection cable
- ⑫ Lower storage compartment
For the mains connection cable, the steamer *, the non-stick soleplate, and the holder for the mains connection cable.
- ⑬ Castors
- ⑭ Release handle
For setting up the steam ironing system

* Supplied as standard with steam ironing system B 3847. Available as optional accessory with steam ironing systems B 3312 and B 3826.

Guide to the appliance

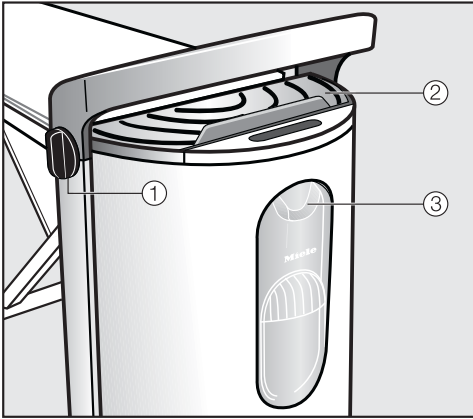

Tower

- ① Rotary dial for height adjustment and folding the appliance away
- ② Iron resting area
- ③ Steam connection

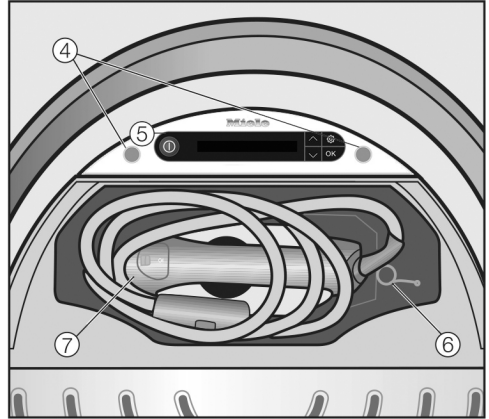

Tower (top view) with open storage compartment (top)

- ④ Sockets for the steam hose holder
- ⑤ Control panel
- ⑥ Steam hose holder
- ⑦ Iron with steam hose

Guide to the appliance

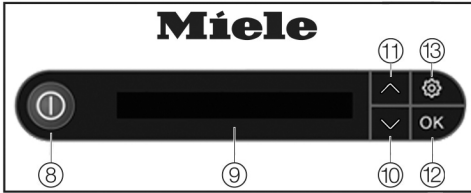

Some of the messages in the display are more than one line long. Touch the ∨ or ∧ button to read them in full.

Control panel on tower

- ⑧ On/Off button ①
Switches the steam ironing system on or off.
- ⑨ Display
Displays messages and instructions for the user.
- ⑩ Arrow button ∨
Lights up if additional options are provided or the display text exceeds the specified length of a line. Scrolls down the selection list to the next option or decreases a value.
- ⑪ Arrow button ∧
Lights up if additional options are provided or the display text exceeds the specified length of a line. Scrolls up the selection list to the next option or increases a value.
- ⑫ OK button
Confirms the selection or the information in the display.
- ⑬ ⚙ button
Opens the settings menu. While in the settings menu, the language and the level of the water hardness can be adjusted, or the descaling process can be started.

Transporting the appliance

The steam ironing system is fitted with two castors. This allows the steam ironing system to be pulled across an even surface when folded up.

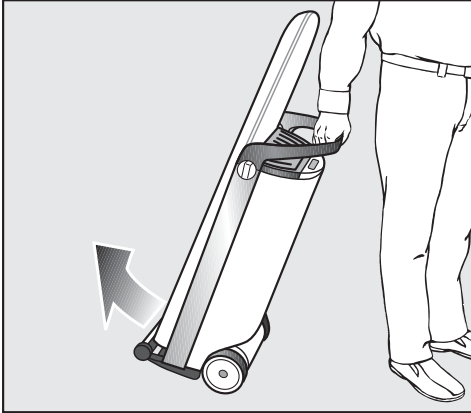

- Hold the steam ironing system by its handle and tip it gently towards you until the castors are free to roll.

This allows you to navigate easily across obstacles such as carpet edges, door thresholds or single steps.

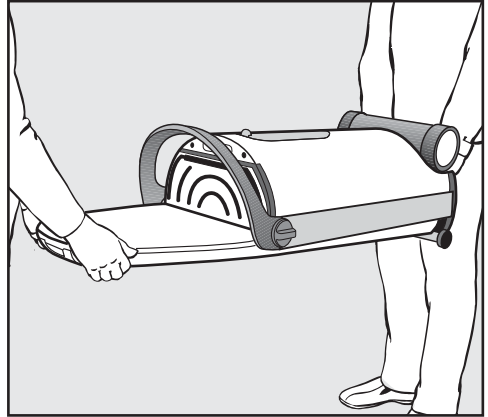

- Two people are required for carrying the steam ironing system up or down stairs. When doing so, ensure the ironing board is at the bottom.

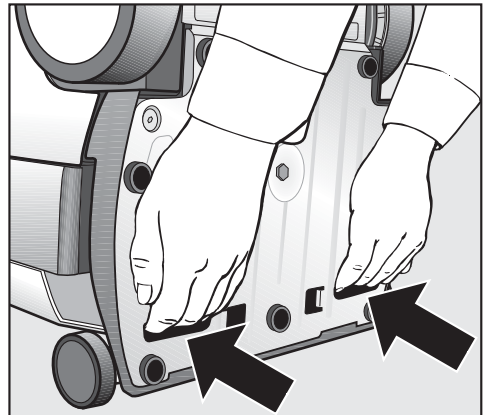

- When transporting the appliance, use both handles on the underside of the appliance.

⚠ The steam ironing system must only be transported or lifted when folded up. Otherwise the locking mechanism of the ironing board could release and cause injury or damage.

Assembling

- Move the steam ironing system to its set-up location.

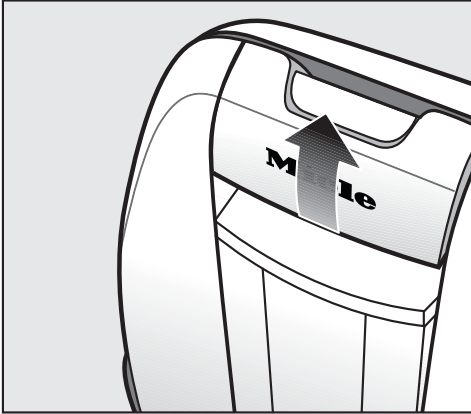

- Use one hand to pull the release mechanism upwards.

This releases the locking mechanism of the ironing board and the X-frame folds down.

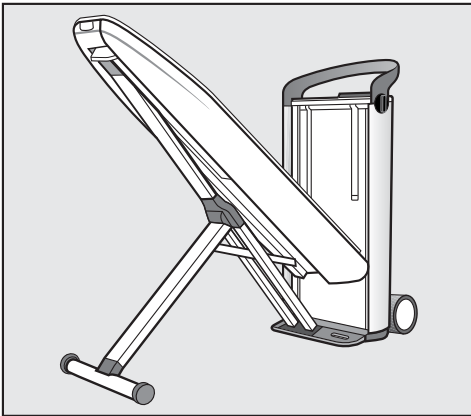

- Hold onto the release mechanism and guide the ironing board into a position of approx. 45°.

The ironing board will remain in this position by itself.

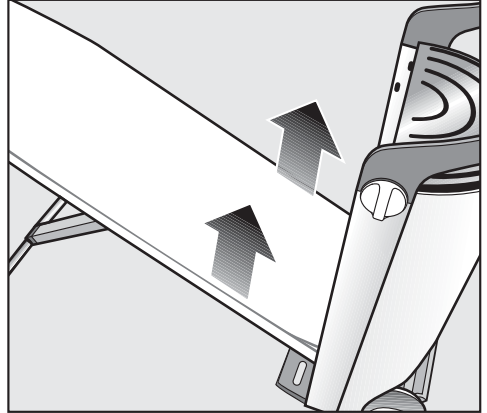

- Use both hands to pull the ironing board upwards into a horizontal position until it audibly clicks into place on both sides of the tower.

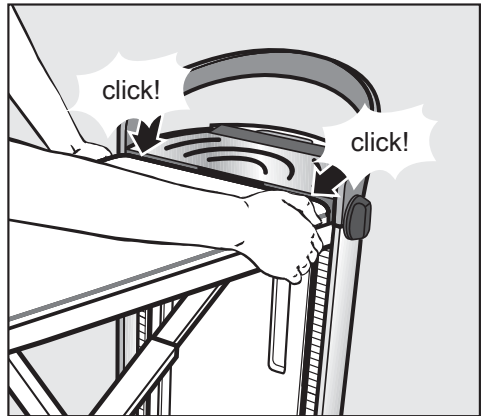

- Ensure the ironing board has locked into place on both sides of the tower.

The height adjustment only works if both sides of the appliance have locked into place.

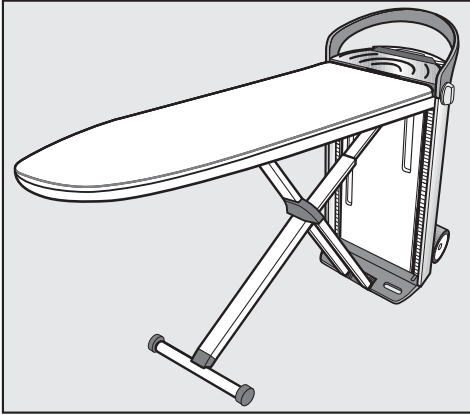

The steam ironing system is now assembled. This is its lowest working position of approx. 83 cm high.

Adjusting the height

The steam ironing system can be adjusted to your preferred working height. The maximum working height is 102 cm.

When adjusting the height, ensure the mains connection cable does not become trapped in the mechanism.

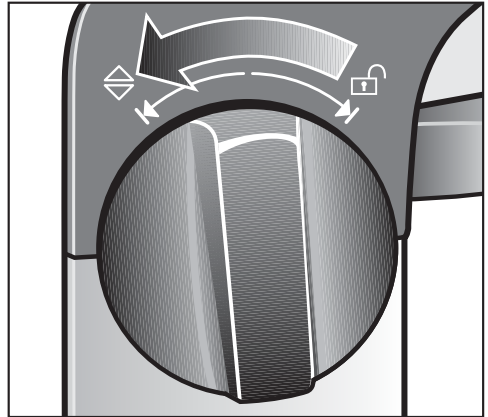

- Using one of the rotary dials located on the side of the tower handle, turn the dial in the ⬠ direction and hold the dial in position.

Assembling

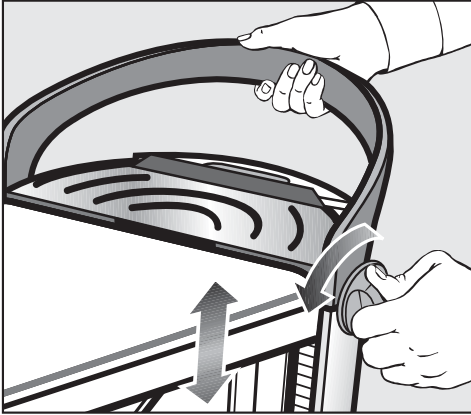

- At the same time, pull the handle on the tower upwards with the other hand or press the handle down.

Do not push down on the ironing board while adjusting the height!
Always use the handle on the tower to do this.

- When you have reached your desired working height, release the rotary dial.

The rotary dial will spring back into the centre position. The ironing board will remain at the adjusted height.

For additional stability, the ironing board locks into place under extra pressure with an audible click. Now the working height you selected is twice as secure.

Useful tip: Adjust your working position to approx. hip height for optimum comfort.

Connecting the mains connection cable

The steam ironing system is designed for connection to a properly installed earthed socket for AC 220-240 V, 50-60 Hz.

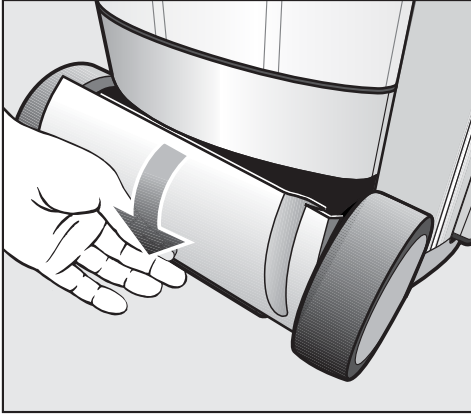

- Open the (lower) storage compartment by swinging the lid downwards.

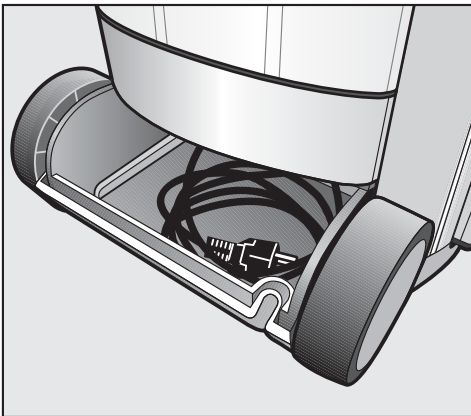

- Remove the mains connection cable from the (lower) storage compartment.

- Insert the plug into a suitable earthed socket (see “Electrical connection”).

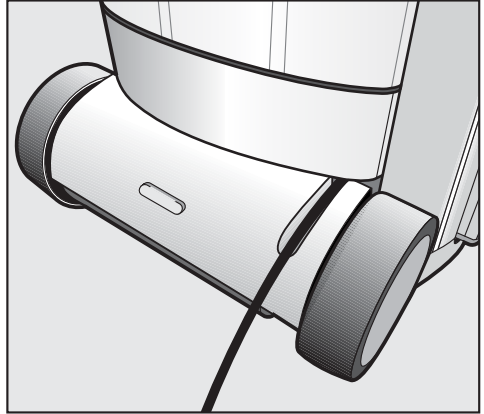

- Guide the mains connection cable through the slot in the lid.
- Close the (lower) storage compartment.

When closing the compartment, ensure the mains connection cable does not become trapped between the lid and the housing or between the castor and the tower.

Connecting

Removing the iron and the steam hose holder

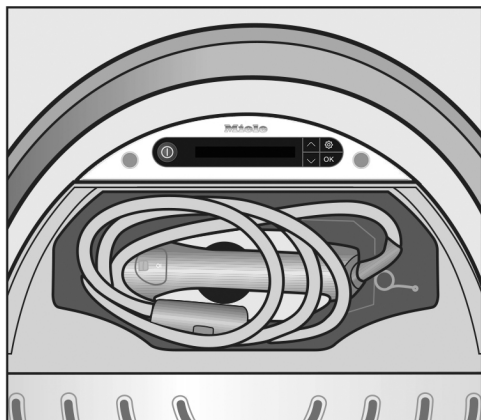

- Open the lid of the (top) storage compartment on the tower.
- Take out the iron and the steam hose holder.
- Close the storage compartment lid.

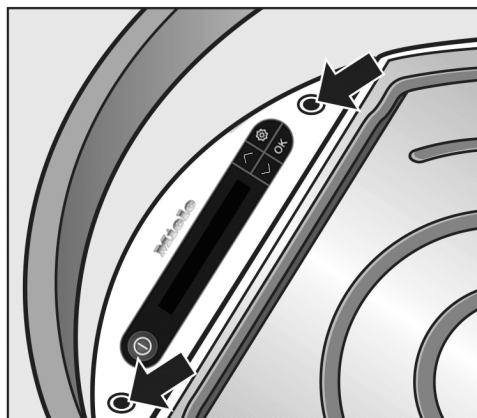

- Plug the steam hose holder into one of the sockets provided.

Useful tip: Use the socket on the side on which you are ironing.

The steam ironing system is suitable for right-handed or left-handed people. Operation is optimised for both sides.

Connecting the steam hose

- Open the steam connection socket by pulling it upwards.

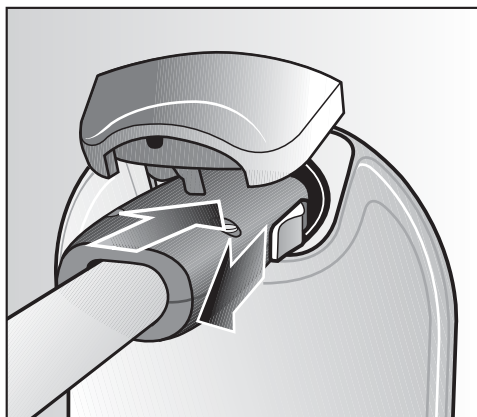

- Pull back the sliding switch on the steam hose plug.
- Insert the plug into the steam connection socket.
- Release the sliding switch on the plug when it is locked into the steam connection socket.

The iron is now connected to the steam connection socket.

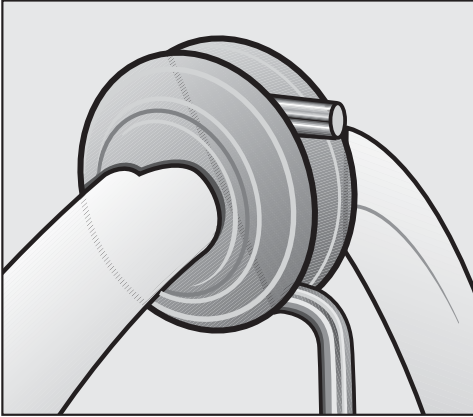

- Slot the rubber ring on the steam hose into the steam hose holder.

Ensure the steam hose is secure and is not twisted.

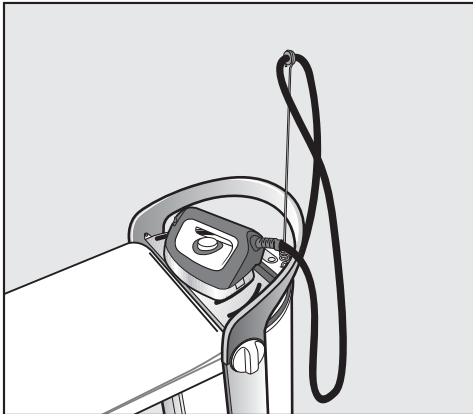

- To avoid damage or discolouration to the ironing board cover, always place the iron on the iron rest before you start ironing and during pauses in ironing.

⚠ Do not place the iron in an upright position!

It can easily tip over or fall to the floor.

Always place the iron onto the iron resting area with its soleplate down.

⚠ If the iron remains on the resting area for any length of time, the surface will become hot.

Avoid direct contact with the iron resting area.

Only touch the handle.

Before turning off the iron, and before placing the iron down, make sure you switch off the continuous steam function.

If the continuous steam function is not switched off, the following message will appear in the display

⚠ Release stm. button.

Unlock the  button by pushing the sliding switch on the iron forwards (see “Ironing”).

Condensation can form on the iron resting area. This does not affect the functioning of the steam ironing system.

Before using for the first time

- Before using the steam ironing system for the first time, remove all packaging (e.g. the protective film from the tower).

Determining water hardness

In order for the steam ironing system to function properly and to display a message prompting you to descale it at the correct time, it is important to set the steam ironing system to the hardness of your local water supply.

The water hardness level indicates how much calcium is dissolved in the water. The higher the calcium content, the harder the water, and the harder the water, the more often the steam ironing system will need to be descaled.

Your local water supplier can inform you of the water hardness level in your area. This information can also be found online on the website of the water supply company.

As an alternative, you can also determine the approximate water hardness by using the test strips supplied.

Using the test strips

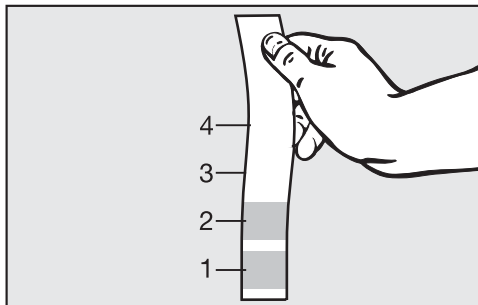

- Dip the test strip in the water for approx. 1 second.
- Remove the test strip from the water and shake the water off the test strip.

After approx. 1 minute, and based on the colouration, you will be able to read the water hardness from the table below:

Hardness range on the test strip

Test strips	Water hardness
4 green zones	< 0.5 mmol/l
1 red zone	> 0.7 mmol/l
2 red zones	> 1.3 mmol/l
3 red zones	> 2.5 mmol/l
4 red zones	> 3.8 mmol/l

Useful tip: It is useful to know your water hardness so that you can provide the service technician with this information in the event of any service calls. Please note your water hardness level here: mmol/l

Before using for the first time

Before using for the first time

- The following steps must be carried out before using the appliance for the first time:

Switching on the steam ironing system





- Press the  button on the control panel on the tower.



The Welcome screen appears for a few seconds in the display. The display will then guide you through the following settings:



Language settings

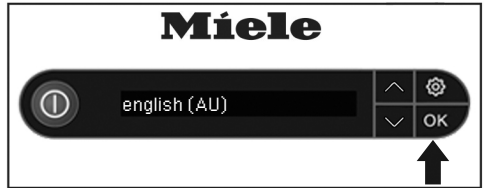

- Use the  or  arrow buttons to select your preferred language.



- Press the OK button to confirm your selection.

The language settings can be changed at any time via the settings menu (, menu option Language ).

Before using for the first time

Setting the water hardness



Before the water hardness can be set, the display message **i** Set water hardness ... must first be confirmed by pressing the OK button.

The steam ironing system gives you the option to set the water hardness to one of 10 settings.

Use the following table to determine the water hardness level that must be set for your steam ironing system:

°dH	mmol/l	°f	Setting
1-4	0.2 - 0.7	2-7	Level 1
5-7	0.9 - 1.3	9-13	Level 2
8-11	1.4 - 2.0	14-20	Level 3
12-15	2.2 - 2.7	22-27	Level 4
16-20	2.9 - 3.6	29-36	Level 5
21-25	3.8 - 4.5	38-45	Level 6
26-30	4.7 - 5.4	47-54	Level 7
31-36	5.6 - 6.5	56-65	Level 8
37-45	6.7 - 8.1	67-81	Level 9
46-70	8.3 - 12.6	83-126	Level 10

Note: If the level in your area falls between water hardness settings in the table, e.g. 0.8, set your water hardness to the next highest level.

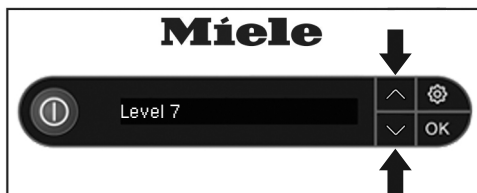

- Use the ∇ or \blacktriangle arrow button on the control panel to set the water hardness level for your household.

Useful tip: If the water hardness fluctuates (e.g. 37 - 50 °dH/6.7 - 9.0 mmol/l), always set the highest value (in this example 50 °dH/9.0 mmol/l = Level 10).

Make sure the correct water hardness level is set. An incorrect setting will invalidate all warranty claims.

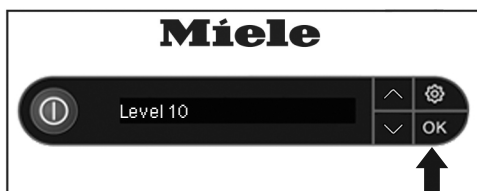

- Confirm your selection by pressing the OK button.

The steam ironing system is now set for the specified water hardness.

The water hardness level can be changed at any time via the settings menu (⚙ button, option Water hardness).

Set-up is now complete

This completes the settings for using the appliance for the first time. The message **i** Initial set-up complete will appear in the display. Confirm this message by pressing the OK button.

The steam ironing system will normally run a rinse cycle automatically after it has been set up for use.

The steam ironing system can then be switched off or you can continue using it.

When using the appliance for the first time, a slight odour may be noticeable during the heating-up phase. This will dissipate with further use.

During operation of the steam ironing system, pumping, boiling and knocking noises may be heard. These are normal noises and do not indicate a malfunction.

Switching on



Switching on the steam ironing system





- Press the  button on the control panel of the tower to switch on the steam ironing system.

The  button lights up and the Welcome screen appears for several seconds in the display.

If the iron was not connected to the steam connection before switching it on, the message  is displayed. In this case, the steam hose must be attached to the steam connection (see “Connecting”).

If the steam button  on the iron is locked when the steam ironing system is switched on,  Release stm. button will appear in the display. If this is the case, first unlock the steam button by pushing the slider on the iron forwards (see “Ironing”).

The message  Heating-up phase then appears in the display. The steam ironing system starts to heat up. During the heating-up phase, some steam may be discharged from the iron.

As soon as the steam ironing system is ready and steam is available, the message  Ready for use will be displayed.

Depending on the operating duration, immediately after switching the steam ironing system on, the automatic rinse function can be started (see “Automatic rinsing”) or you may be prompted to start the descaling process (see “Descaling”). The steam ironing system is not available for ironing while the rinse or descaling process is running.

Filling the water container

If the water container is empty or not fitted in the tower, the message  Fill water cont. will appear in the display.

Removing the water container

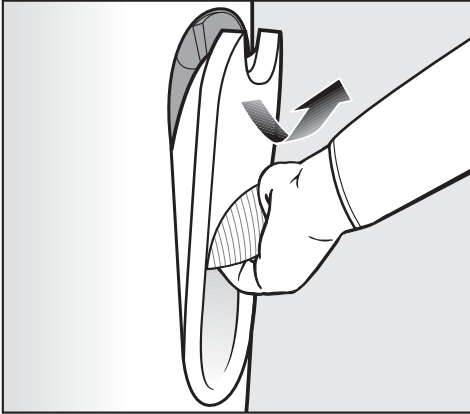

- Hold the water container by its handle.
- Pull the handle downwards.

The water container will release from the retainer.

- Pull the water container upwards and out.

When removing the water container, you may notice some water dripping while the water container valves are closing.

Useful tip: The dripping can be prevented by removing the water container slowly.

Filling the water container

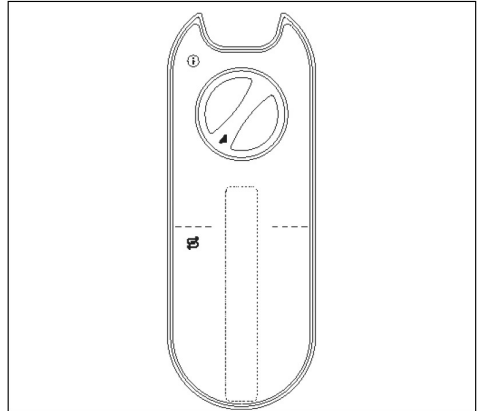

- Open the screw cap at the rear of the water container by turning the cap anti-clockwise.
- Remove the screw cap.
- Fill the container with fresh tap water (water temperature approx. 15 - 35 °C).

Useful tip: By placing the water container in the horizontal position, the water container can also be filled under very low taps.

- Replace the screw cap on the water container.
- Close the screw cap by turning it clockwise as far as it will go.
- Fit the water container back in the tower.

The water container can be removed and refilled at any time (even during the ironing process). The amount of water required will depend on how much steam is required.

Switching on

Steam operation



After inserting the water container, wait until the steam ironing system is ready to use steam. This is indicated by the Ready for use message in the display.

If the water container is refilled during the ironing process, the steam generator may have to reheat.

Useful tip: If you fill the water container as soon as the Fill water cont. message is displayed and the container is inserted into the tower there is no delay.

The steam ironing system is not active whilst the message Fill water cont. is shown in the display. However, you may continue to use the iron.

Useful tip: You can save energy by ironing dry and without steam. To do this, remove the water container. In this case, the steam generator will not be heated. As a result, the inflation and suction function of the ironing board is not available (see “Active ironing board”).

Water quality

- Use only fresh tap water.
- Water prepared using commercially available water filters may also be used.

For water hardness of more than 14 °dH / 2.5 mmol/l, you can use tap water mixed at a 1:1 ratio with distilled water. This halves the water hardness. Set the halved water hardness to the corresponding level on the steam ironing system (see “Setting the water hardness”).

If your tap water has a water hardness of 60 °dH / 10.8 mmol/l, the mixing ratio of 1:1 with distilled water results in a water hardness of 30 °dH / 5.4 mmol/l. The water hardness level that must be set on your steam ironing system must now be Level 7.

Never use solely demineralised (distilled) water to fill the water container.

This may cause the steam ironing system to malfunction.

Do not use water from a water softener system.

Do not use condensate (e.g. from other appliances such as air conditioning units or dryers).

Never use rainwater.

Do not use additives in the water, (e.g. perfumes, ironing water, starch, carbon dioxide).

Selecting the ironing temperature

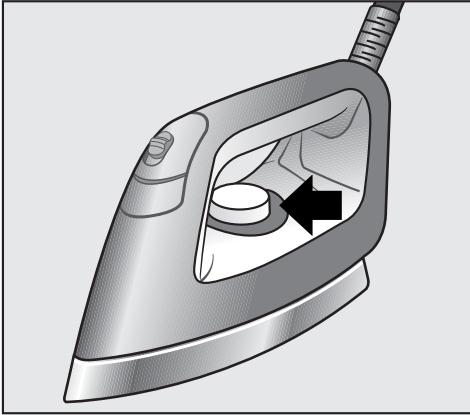

Use the temperature selector on the iron to set the ironing temperature.

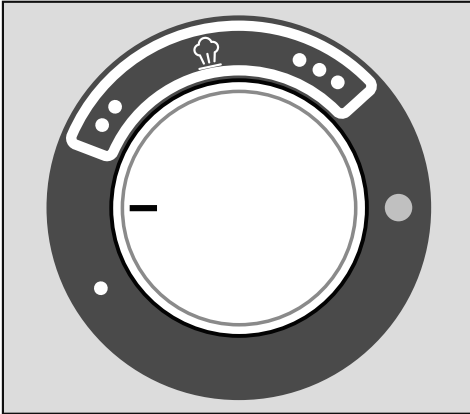

The temperature settings are indicated by dots around the selector. These dots correspond to the international care symbols used for ironing.

At temperature levels **••** and **•••** you can use steam when ironing.

With temperature level **•** the soleplate temperature is too low for ironing with steam. If you use this temperature level, do not use the  steam button.

If you do, water will escape from the steam jets.









Useful tip: Sort your laundry according to the heat sensitivity of the fabric. This allows you to iron faster: First, iron your laundry that is made of heat-sensitive fabric (e.g. synthetics) at temperature level **•**. Then, iron all laundry made of wool or silk, using temperature level **••**. Finally, iron all laundry made of cotton and linen, using temperature level **•••**.

- Set the temperature selector to the required temperature setting.

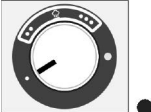
The indicator light on the temperature selector will light up yellow whilst the iron is heating up. It will go out once the set temperature has been reached.

The iron is then ready for use.

Switching on

Care label (on the garment)	Ironing with steam for best results (Material / Temperature setting)	Ironing without steam (Material / Temperature setting)
 Low temperature	<p>With non-stick soleplate (see “Ironing with the non-stick soleplate”)</p> <p>Minimum iron, synthetics, appliqués, prints, flocking, etc.</p> 	Minimum iron, synthetics 
 Medium temperature	Woollens, silks 	
 High temperature	Cottons, linens 	
	Do not iron	

CoolDown function

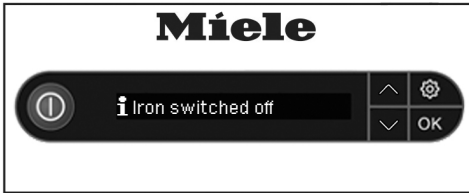

The heating of the iron switches off automatically if the iron is not moved for longer than 3 minutes. The message **i** appears in the display to indicate that the heating has switched off. After a certain time, steam is no longer available. The message **⚠** Release stm. button appears when the steam button is locked. In this case, unlock the **☞** steam button by pushing the slider on the iron forwards (see "Ironing").

⚠ The soleplate is still hot immediately after the heating has been switched off!
Avoid direct contact.

As soon as the iron is moved, or the steam button has been released, the iron will start heating up again automatically. The time taken for the steam to be available again depends on the length of time the heating was switched off.

When the steam ironing system is ready and steam is available, the message **☞** Ready for use will be shown in the display on the tower.

⚠ Do not leave the steam ironing system unattended with the iron or steamer connected!

Always switch off at the wall socket and withdraw the plug before leaving the steam ironing system unattended.

AutoOff function

If the iron or the steamer is not used for approx. 25 minutes, the entire steam ironing system switches off automatically.



The steam ironing system is switched on again by pressing the **⏻** button on the control panel.



Ironing

Iron

Depending on the model, your steam ironing system has one of the following irons:

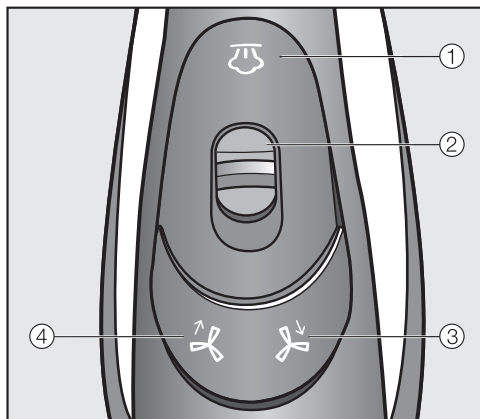

Steam ironing system B 3312:



- ① Steam button 
- ② Sliding switch for continuous steam
- ③ Suction function button 
- ④ Inflation function button 

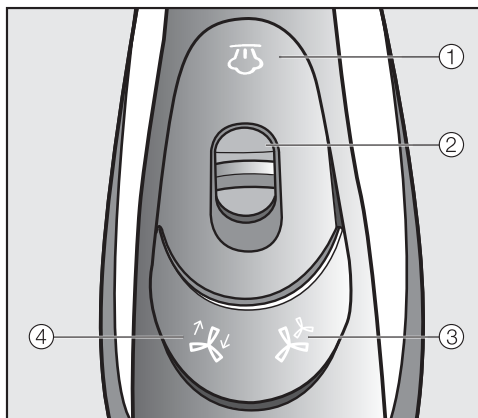

Steam ironing system B 3826 / B 3847:





- ① Steam button 
- ② Sliding switch for continuous steam
- ③ Power level button 
- ④ Inflation/Suction function button 

Irons supplied with previous Miele steam ironing systems (B 1xxx/B 2xxx) cannot be used with this appliance.

Ironing with steam

The steam system is ready for use when  Ready for use appears in the display. The burst of steam is controlled by the  button on the iron.

When the  button is pressed, the fan on the underside of the ironing board starts automatically.



When the  button is released, the fan will also stop automatically after a brief time delay.



When using the steam function for a long time, make sure the room is well ventilated, as high air humidity can develop.

Using short bursts of steam

- Briefly press the  button and release it again.

Using continuous steam

- Press the  button and at the same time pull the sliding switch  back.
- Release the  button again.



While the sliding switch  is pulled back, the  button remains in a locked position.

Steam is now emitted continuously.

Stopping the continuous steam function

- Push the sliding switch  forwards.

This will unlock the  button again and the steam burst function is ended.

The continuous emission of steam must have stopped before the iron is put back on the resting surface. If the steam button was not unlocked before placing the iron down, steam will stop being produced after approx. 3 minutes and  Release stm. button will appear in the display. When turning off the iron, unlock the  button by pushing the sliding switch  forwards.

Filling the water container

- Fill the water container when the message  Fill water cont. appears in the display (see “Filling the water container”).

When using the steam function for a long time during ironing, condensation can build up in the ironing board.

Sensitive floors can be damaged by droplets of water.

If you notice condensate underneath the ironing board, use a cloth to wipe it up.

Useful tip: If you take a break from ironing, condensate may collect in the steam hose. When the  button is pressed, the condensate is expelled from the hose. To avoid damp spots on your clothes, do not direct the first burst of steam onto the garment after a break from ironing.

Ironing

Ironing without steam

- Remove the water container from the steam ironing system if you want to iron without steam.

The steam generator will not heat up, thus saving you electricity.

Ironing with the non-stick soleplate

There is a non-stick soleplate in the (lower) compartment. Simply clip the soleplate onto the iron.

With the non-stick soleplate you can iron appliqués, prints, flocking etc. There is no need to turn the garment inside out. This soleplate also reduces or eliminates the formation of shiny patches on dark textiles.

Always try it first on an inconspicuous part of the fabric.

 The iron soleplate gets very hot during use. Avoid direct contact.

Attaching the non-stick soleplate

- Place the tip of the iron inside the non-stick soleplate.

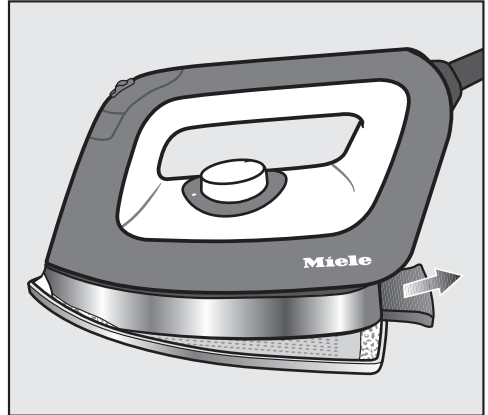

- Pull back the tab which is located at the back of the non-stick soleplate.
- Hold the tab in this position.
- Push the iron completely onto the non-stick soleplate.
- Release the tab again.

The non-stick soleplate is now secured onto the iron.

- Before you start ironing, let the non-stick soleplate heat up for approx. 1 minute until it has reached the ironing temperature.

The iron is now ready for use.

Removing the non-stick soleplate

- Hold the iron by the handle.

⚠ The non-stick soleplate is still very hot after ironing. Avoid direct contact. Only touch the tab of the non-stick soleplate.

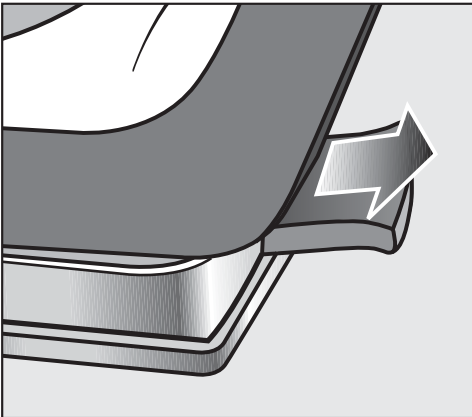

- Pull back the tab at the back of the non-stick soleplate.
- Remove the iron from the non-stick soleplate.
- Only store the non-stick soleplate in the storage compartment (lower) after the soleplate has cooled down.

Active ironing board

The steam ironing system uses a fan that sucks away the steam or uses the inflation function to inflate the ironing board for optimum positioning while ironing garments.

The buttons on the iron control the fan in the ironing board.

Suction function

The suction function ensures optimum steam penetration of the fabric. At the same time, the suction avoids the formation of condensation on the ironing board. The suction function also holds the garment in place and ensures it does not shift on the ironing board.

Inflation function

The inflation function forms a cushion of air between the fabric and the ironing board. This helps prevent seams being pressed into the garment. The inflation function allows you to iron without flattening the fabric.

Useful tip: The inflation function also assists with ironing ruffles and sequins.

Automatic switch on/off

The automatic switch on/off feature ensures that the fan starts at exactly the right moment. If the steam function is being used, the fan starts automatically.

If steam is no longer needed, the fan will stop after a short run-on time.

Ironing

Memory function

The memory function saves the fan direction and the power setting used last with your steam ironing system. When you use the appliance the next time, you do not need to set it again.

Heated ironing surface

When the iron is connected and the steam ironing system is switched on, the surface of the ironing board will heat up automatically. This function reduces the formation of condensation on the ironing board.

If the steamer is connected to the steam ironing system, the surface of the ironing board will not be heated.

Fan control for the B 3312:

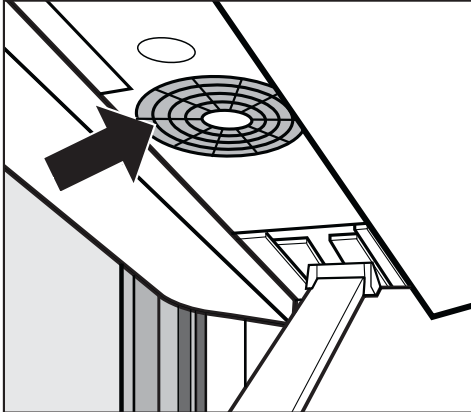

The  button activates the inflation function.

The  button activates the suction function.

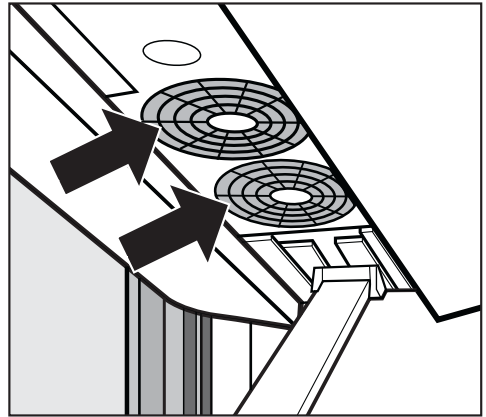

Fan control for the B 3826 / B 3847:



Activating the inflation and suction function

Press the  button to switch between the inflation function and the suction function. Use the button to activate the function.

Setting the power level

When using the  button, you can switch between both fan power levels. Each press of the  button switches between the following power levels:

- Level 1 = 1 fan active
- Level 2 = 2 fans active

The B 3847 steam ironing system is equipped with a steamer in addition to the iron. The steamer is available as an optional accessory for the B 3312 and B 3826 steam ironing systems.

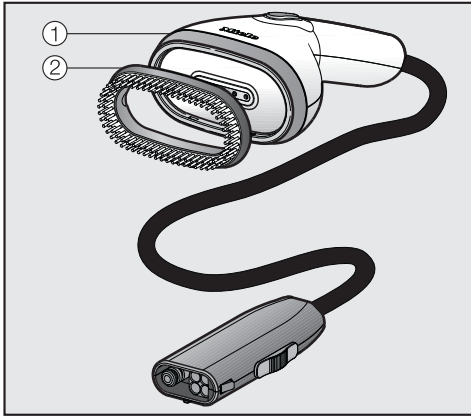

The steamer ① makes ironing hanging garments easier, e.g. dresses and jackets. It comes with a removable brush attachment ② for lifting the fibres.

The steamer weighs less than the iron and also does not have a hot soleplate, therefore eliminating the risk of shiny patches if it accidentally comes into contact with the fabric.

The steamer can also be used when the appliance is folded up.

The steamer supplied with earlier steam ironing systems (B 1xxx/B 2xxx) cannot be used with this appliance.

Connecting the steamer

You can also plug the steamer into the steam connection socket of the ironing system as an alternative to the iron.

Disconnecting the iron from the steam connection socket

 The iron soleplate is still very hot after use!

Avoid direct contact.

Place the iron on its resting surface and let it cool down completely before you store it away.

Do not pull on the steam hose.

Always pull on the plug at the end of the steam hose when disconnecting it from the steam connection socket.

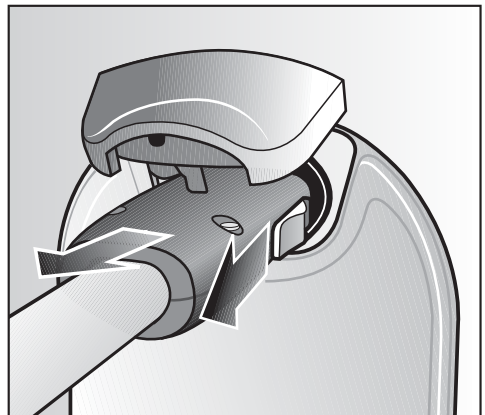

- Pull back the sliding switch located on the side of the steam hose plug.
- Hold back the sliding switch.
- Withdraw the plug from the steam connection socket.

Steamer

Now you can connect the steamer to the steam connection socket.

Attaching the steamer to the steam connection socket

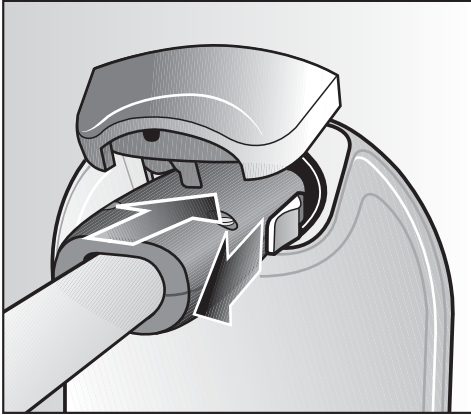

- Pull back the sliding switch located on the side of the steam hose plug.
- Insert the steam hose plug into the steam connection socket on the tower.
- Release the sliding switch when the plug has locked into place in the steam connection socket.

The steamer is now attached to the steam connection socket.

You can plug the iron into the steam connection socket as an alternative to the steamer at any time.

You do not need to switch off the steam ironing system to do this.

After switching between the iron and the steamer, there is a short interval before the steam is ready. This ensures that sufficient steam is available.

The steamer is ready when the message  Ready for use appears in the display.

Using the steamer

 Danger of burning due to hot steam!

Never direct the steam or the steam jets at people, animals or electrical appliances of any kind.

Never point the steam at clothing while the clothes are being worn. The clothing will intensify burning of the skin.

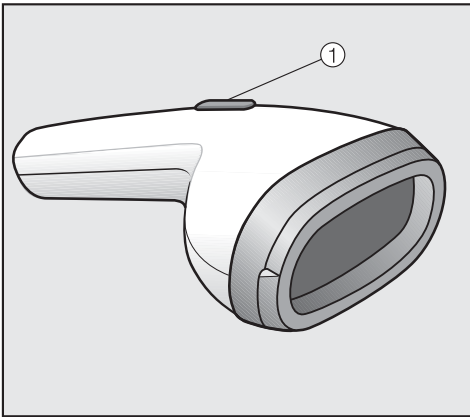

The emission of steam is controlled by the ① button on the steamer.

Useful tip: Always steam the fabric in the direction of the fibres.

Using short bursts of steam

- Briefly press the ① button.
- Then release the button.

Using continuous steam

- Press the ① button.
- Keep the button pressed in.

Stopping the continuous steam function

- Release the ① button.

If you take a break from steaming, condensate may collect in the steam hose. Press the ① button to expel the condensate from the hose.

The optimum distance between the steamer and the fabric depends on the sensitivity of the fabric and can vary from one fabric to another. Always try it first on an inconspicuous part of the fabric.

Steamer

Brush attachment

The steamer is equipped with a brush attachment which can be clipped on. The brush attachment helps to raise garment fibres.

You can hold the steamer directly onto the fabric while the brush attachment is in place. Always try it first on an inconspicuous part of the fabric.

Connecting the brush attachment

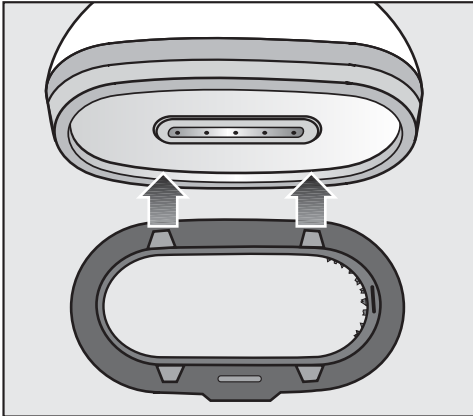

- Hold the brush attachment in front of the steamer so that the lugs on one side fit into the notches on the steamer.
- Press the side of the brush attachment against the steamer until the lugs snap into place.

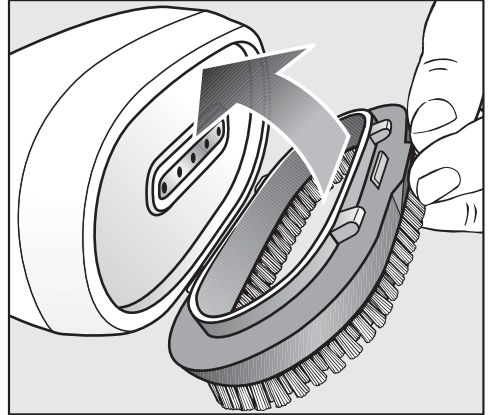

- Guide the brush attachment into the notches on the opposite side.
- Press the brush attachment against the steamer until the lugs snap into the notches.

The brush attachment is now connected to the steamer and can be used.

Removing the brush attachment

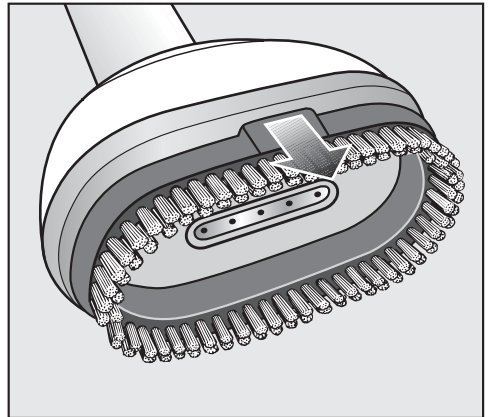

- To remove the brush attachment, pull it off the steamer by the raised section.

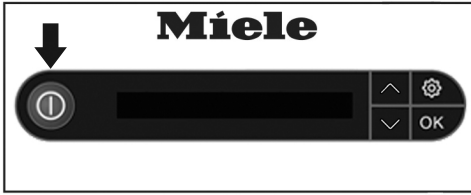

- To switch off the steam ironing system, press the  button on the control panel.

The light in the  button goes out.

The steam ironing system is now switched off. The last selected fan settings are saved and are available for the next time you switch on the appliance.

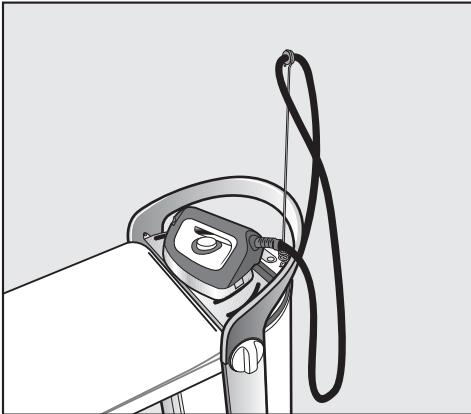

- Place the iron on the resting surface until it has cooled down.

The steam ironing system can be dismantled while the iron is cooling down (see “Dismantling”).

- Switch off at the wall socket and remove the plug.

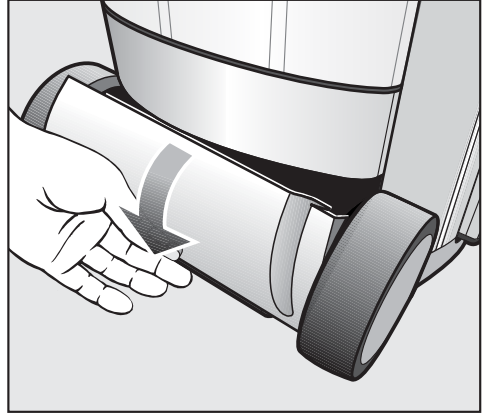

Lower storage compartment

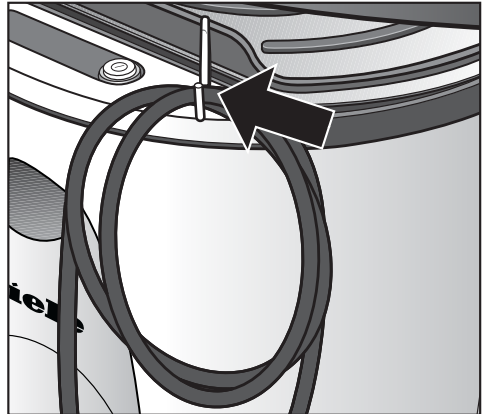

Clip for the mains connection cable

- Store the mains connection cable in the (lower) compartment or hang it up on the cable clip.



The cable clip can be found in the (lower) compartment and can be pushed into one of the sockets for the steam hose holder.

Dismantling

Setting the ironing board to its lowest working height

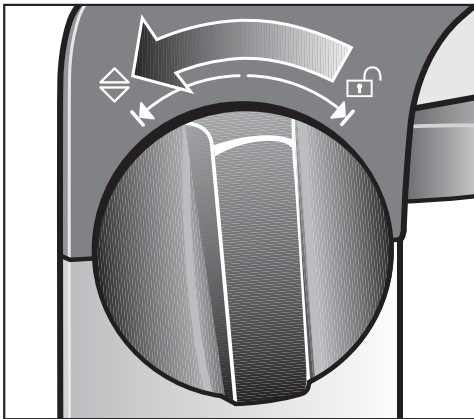
To dismantle the steam ironing system, the ironing board must first be set to its lowest working height. Make sure you do not trap the mains connection cable in the system. Ensure the residual water drawer is completely emptied, pushed in and clicked into place.



- Turn one of the rotary dials on the side of the tower handle as far as it will go in the  direction.
- Hold the rotary dial in the  position. The height of the ironing board can now be adjusted.

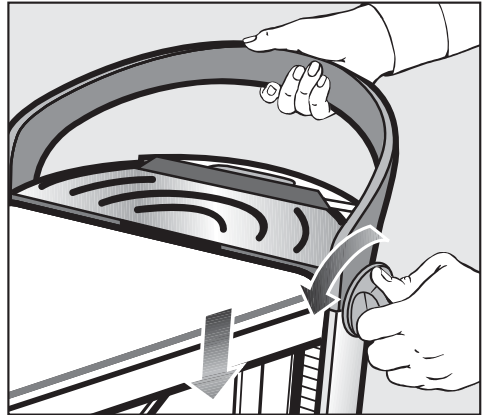

- Keep holding the rotary dial in the  position and, simultaneously, use the handle on the tower to push the ironing board down as far as possible.

Never push on the ironing board to push it down. Use only the handle on the tower to push the ironing board down.

- Release the rotary dial.

The rotary dial will spring back into the centre position.

The ironing board is now at its lowest working height and can be folded away.

After withdrawing the plug, drops of water may escape from the steam hose.

Folding the ironing board

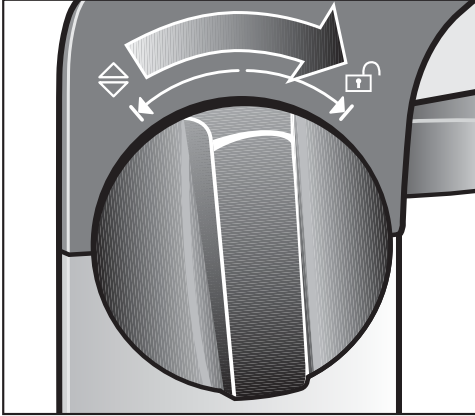

- Turn one of the two rotary dials as far as it will go towards the  position.

The ironing board is now unlocked.

- Release the rotary dial.

The rotary dial will spring back into the centre position.

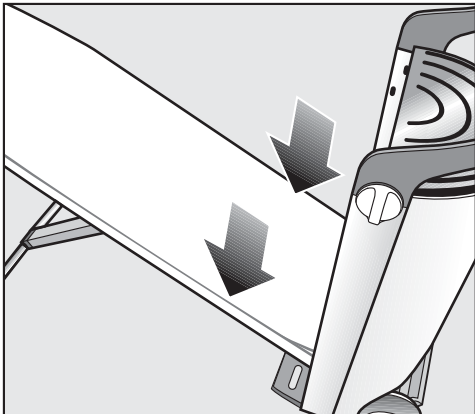

- Guide the ironing board downwards or allow it to slide down by itself.

The ironing board will remain in this position by itself.

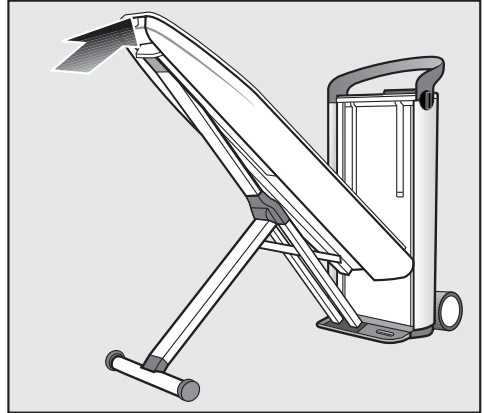

- Push the ironing board up by the tapered end until it is upright and locks into position on the tower.

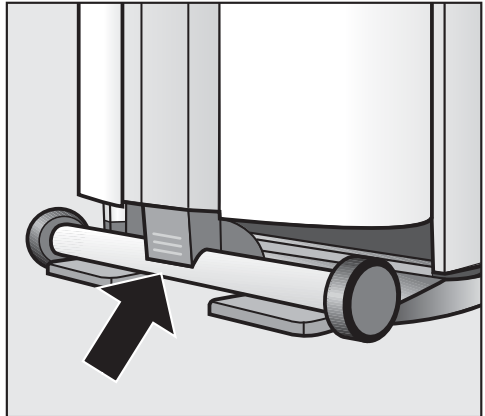

- Push the protruding end of the X-frame onto the ironing board until the frame locks into place.

Dismantling

Disconnecting the steam hose

Do not pull on the steam hose. Hold the plug at the end of the steam hose. The plug may still be warm immediately after using the system.

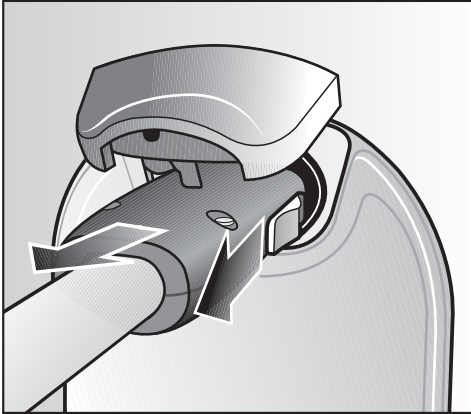

- Pull back the sliding switch located on the side of the steam hose plug.
- Hold back the sliding switch.
- Withdraw the plug from the steam connection socket.

After withdrawing the plug, drops of water may escape from the steam hose.

Storing the iron

 The iron soleplate is still very hot after use!
Avoid direct contact.
Allow the iron to cool down after use.
Do not stow the iron away while it is still attached to the hose.

- Place the iron on the resting surface on the tower and let the iron cool down.
- When cool, store the iron and the steam hose holder in the (top) storage compartment.

Storing the steamer

Never put the steamer away while it is still connected to the steam connection socket.

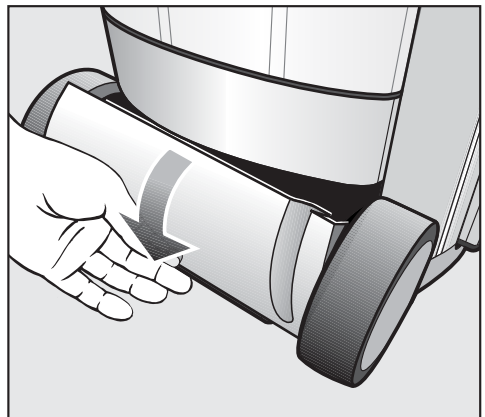

- Store the steamer in the (lower) storage compartment.

Emptying the water container

Empty the water container if the steam ironing system is not going to be used for a long period of time.

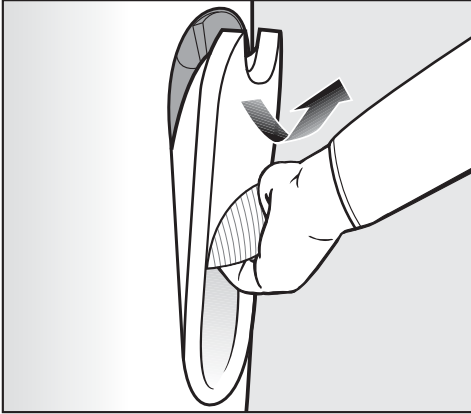

- Remove the water container (see “Filling the water container”).
- Make sure the water container is completely emptied.

Storing the steam ironing system

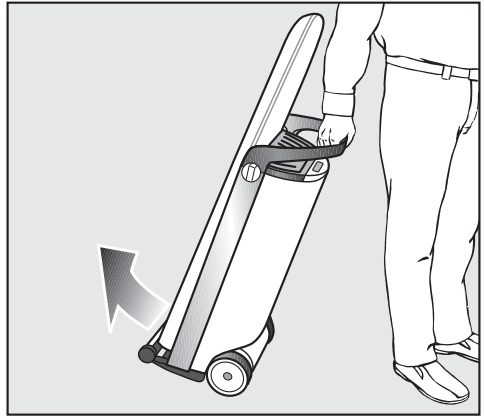

- Take the steam ironing system to its storage place.

Do not store the steam ironing system in a room where temperatures below freezing may occur.

Frozen water can cause damage to the water container, steam generator and steam hose.

Cleaning and care

Automatic rinsing

The automatic rinse function clears the steam generator of mineral deposits from the evaporated water.

After approx. 3 litres of water have been passed through the system, the rinse process will start automatically the next time the steam ironing system is switched on.

The rinsing process takes several minutes. Steam escapes and splashing noises can be heard. At the same time the message  Appliance rinsing will be shown in the display on the tower.

The iron cannot be used while the rinsing process is in progress. The steam ironing system can only be used again once the automatic rinsing process is completed.

Preparing for the rinsing process

- Set the steam ironing system to its highest working position to enable the residual water drawer to be removed later on (see “Assembling - Adjusting the height”).
- If the message  Fill water cont. appears in the display, fill the water container (see “Filling the water container”).

Emptying the residual water drawer

After the rinsing process has finished, the residual water drawer must be emptied. The message  Empty drawer will appear in the display on the control panel when the residual water drawer needs to be emptied. The residual water drawer can only be removed from the tower when the steam ironing system is set at its highest working level.

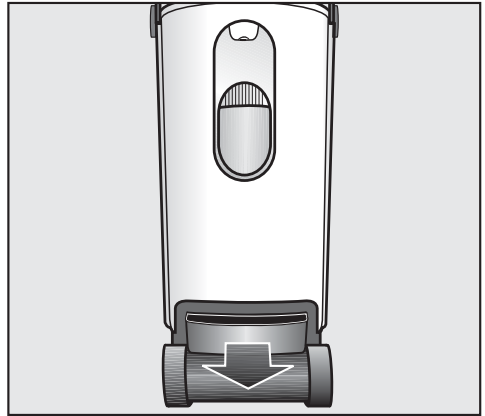

- Only remove the residual water drawer from the tower when prompted to do so by the message  Empty drawer in the display.

The residual water drawer may still be warm after the rinsing process.

- Empty the residual water drawer.

As long as the residual water drawer is not fitted in the tower, the display will show the following message  Fit drawer.

- Clean and dry the residual water drawer.

The residual water drawer is dishwasher-safe or can be washed by hand using warm water and a little washing-up liquid.

Make sure the metal discs (contacts) at the top of the residual water drawer are clean and dry. These metal discs send a signal to the steam ironing system when the residual water drawer is full or if it is fitted in the tower.

The discs will not function correctly if they are dirty or damp.

- Slide the residual water drawer back into the tower until it clicks into place.

Steam cannot be produced until the empty residual water drawer is replaced in the tower. Steam is only available again when the message  Ready for use appears in the display.

Descaling

The steam ironing system must be descaled regularly to ensure that it functions correctly. The steam ironing system has an automatic descaling function to assist you.

The interval for descaling depends on the water hardness level set. Descaling is required more frequently with hard water than with soft water.

We recommend using the Miele descaling tablets. These have been specially developed for use with Miele appliances to optimise the descaling process. Your appliance is supplied with one pack of Miele descaling tablets.

Other descaling agents, which contain other acids besides citric acid and/or other undesirable substances, such as chlorides, could damage the steam ironing system. Moreover, the required descaling effect cannot be guaranteed.

You will need 1 descaling tablet to descale the machine.

Miele descaling tablets are available to order from Miele (see “Optional accessories”).

The iron or steamer must not be connected during descaling of the steam ironing system.

The steam ironing system can be left unattended during descaling, provided that the iron or steamer is not connected.

Cleaning and care

Descaling warning

☞ Descal soon will appear in the display the next time you switch the steam ironing system on if there are only about 2 hours of ironing available before the system needs descaling.

You can start the descaling process whilst the system is cold via the Settings menu (see “Starting the descaling process early”) or you can press the OK button to confirm the message in the display and continue ironing as normal. The ☞ symbol will continue to show in the display until descaling is carried out.

After the remaining operating hours have elapsed, the descaling process must be carried out before the steam ironing system can be used again.

You can also start the descaling process at a time that suits you (see “Starting the descaling process early”).

You can interrupt the descaling process by switching the steam ironing system off with the ① button. When you switch the system back on, descaling will start again from the point where the process was interrupted.

The messages in the display will guide you through the descaling process. The entire descaling process takes approx. 90 minutes.

Only proceed with stages of the process when prompted to do so by the appropriate message in the display. Once the descaling process has started, your presence is required after around 20 minutes and again after a

further 60 minutes. For the rest of the descaling process, you can leave the steam ironing system unattended.

Useful tip: To optimise the descaling process, start the procedure while the system is still cold immediately after switching the steam ironing system on. This way, you will avoid a delay of up to 3 hours that may be caused by the cooling phase.

Starting the descaling process early



- When the steam ironing system is switched on, press the  button on the control panel.

The settings menu will be displayed. Use the arrow buttons to select individual settings.



- Use the  or  arrow buttons to select the *Descal* option.

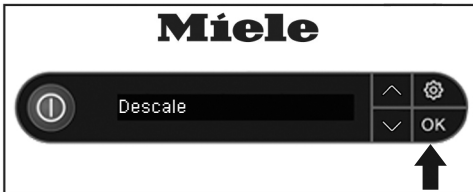

- Confirm your choice by pressing the OK button.
- Select the *Start descaling* option.
- Confirm your choice by pressing the OK button.

The descaling process will now start.

Descaling process

The following display messages will guide you through the entire descaling process. Only proceed with the required action if you are prompted to do so by the appropriate message in the display.

i Detach hose

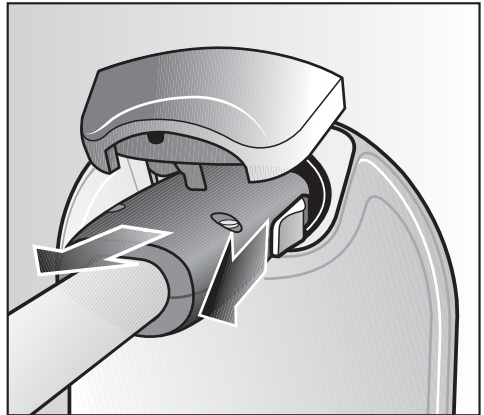

- Remove the steam hose of the iron or the steamer from the steam connection socket on the tower.

The iron or the steamer must not be attached to the steam connection socket at any time during the descaling process.

Cleaning and care

Fill water container to mark

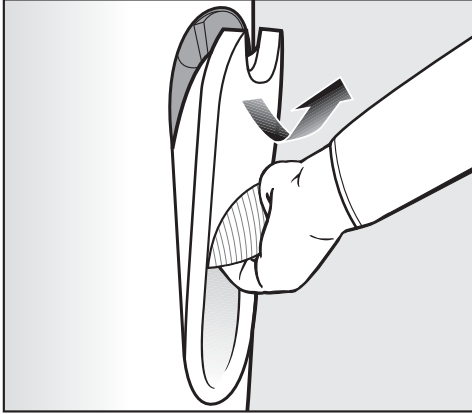

- Hold the water container by its handle.
- Pull the handle downwards.

The water container will release from the retainer.

- Pull the water container upwards and out.

When removing the water container, you may notice some water dripping while the water container valves are closing.

Useful tip: The dripping can be prevented by removing the water container slowly.

After removing the water container, the message **i** Add descaler will appear in the display.

i Add descaler

- Turn the screw cap at the back of the water container anti-clockwise and remove the cap.

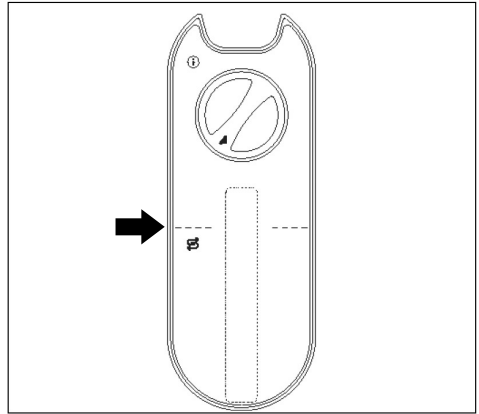

Level mark on the water container

- Use fresh tap water to fill the water container (water temperature approx. 15 to 35 °C) to the level mark. It is important not to fill the water container with more or with less water.
- Add 1 descaling tablet to the water container.
- Replace the screw cap on the water container.
- Turn the screw cap clockwise as far as it will go.

The screw cap is now closed.



- Press the OK button to display the next step.

The message  Fit water container will now appear in the display.

Fit water container

- Fit the water container back in the tower.

After about 10 minutes (the time it takes for the descaling tablet to dissolve), the descaling process begins automatically. Messages in the display will tell you when to empty the residual water container or when to fill the water container.

If the water container becomes empty during descaling or if it is removed from the tower unprompted, the message  Fit or refill water container will appear.

During the descaling process, water is pumped into the steam generator at various times and is drained back again into the residual water drawer. Some steam will escape and splashing noises can be heard during this process.

Cleaning and care

Empty drawer

This message may be displayed after inserting the water container with the descaling tablet. If you do not see this message, you can skip the following steps and continue as soon as you see  Pre-rinse in the display.

- Set the steam ironing system to its highest working position in order to remove the residual water drawer (see “Assembling - Adjusting the height”).

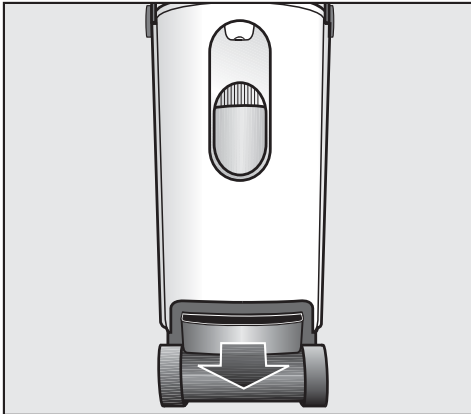

- Remove the residual water drawer from the tower.

The residual water drawer may still be warm after the rinsing process.

- Empty the residual water drawer.

As long as the residual water drawer is not inserted into the tower, the display will show the following message  Fit drawer.



Fit drawer

- Slide the residual water drawer back into the tower until it clicks into place.

Pre-rinse

If the steam ironing system is still hot from the previous use, the cooling down phase will start first. This may take up to 3 hours.

The pre-rinse phase then follows (duration approx. 20 minutes). During this time, a portion of the descaling solution is pumped into the steam generator.

After the pre-rinse phase you will be prompted to carry out further actions. This will be shown for a few seconds before the pre-rinse phase starts and will be indicated by the message  In 20 min. .

Rinse water container and fill to the mark

- Remove the water container from the tower.

As long as the water container is not fitted in the tower, the display will show the following message  Fit water container.

- Open the screw cap.
- Rinse the water container thoroughly. Make sure no residues of the descaling tablet remain in the water container.
- Fill the water container with fresh tap water at least up to the level mark.
- Close the screw cap.
- Fit the water container back in the tower.

Empty drawer

- Remove the residual water drawer from the tower.

The message  Fit drawer will appear in the display.

- Empty the residual water drawer.
- Slide the residual water drawer back into the tower until it clicks into place.

Cleaning and care

Descale

After an activation time of approx. 1 hour, the descaling solution is drained from the steam generator into the residual water drawer.

The steam generator is then rinsed with water. This rinse cycle takes approx. 5 minutes. Before starting, the

 Rinsing (5 min.) message is displayed for a few seconds.

During the rinsing cycle, the message  Rinsing is displayed.

Once the rinsing cycle is completed, the water is drained completely into the residual water drawer and the message  Empty drawer is displayed.

Empty drawer

- Remove the residual water drawer and empty it.

The message  Fit drawer is now shown in the display.

- Rinse the residual water drawer thoroughly.

The residual water drawer is dishwasher-safe or can be washed by hand using warm water and a little washing-up liquid.

- Dry the residual water drawer. Make sure that the metal discs (contacts) at the top of the residual water drawer are clean and dry.
- Slide the residual water drawer back into the tower until it clicks into place.

The message  Descaling finished will appear in the display.

- Press the OK button.

The soleplate of the iron must then be rinsed.

Rinsing the soleplate

The iron must not be warm from previous use.

Let the iron cool down for at least 60 minutes before rinsing the soleplate.

- Make sure that the non-stick soleplate has been removed from the iron.

If the non-stick soleplate is still on the iron, remove it now (see “Ironing - Removing the non-stick soleplate”).

- Fill the water container with fresh tap water (see “Filling the water container”).
- Set the temperature selector on the iron to “cold” so that the line on the selector is pointing to the indicator light.

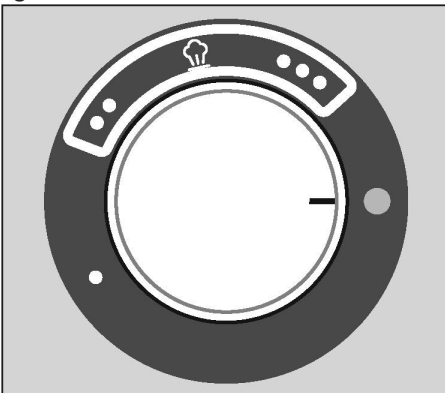

- Plug the steam hose of the iron into the steam connection on the tower (see “Connecting the steam hose”).

If the steam ironing system is switched off, switch it on now by pressing the  button. When the steam ironing

system is ready and steam is available, the message  Ready for use will be shown in the display.

- Hold the iron over a washbasin or a heat-resistant container. You can also use the residual water drawer from the steam ironing system. Be aware, though, that the drawer can only be taken out of the steam ironing system once the appliance is switched on.

 During the rinsing process, hot water and steam come out of the iron.

Danger of burning!

Never direct the iron at people, animals or electrical appliances of any kind.

- Press the  button on the iron for around a minute and tilt the iron. Keep the tip of the iron pointing downward slightly.

Hot water and steam will come out of the iron and dislodge any deposits that have built up. As soon as there is only steam coming out, you can release the  button.

Cleaning and care

- Now set the temperature selector on the iron to the highest temperature setting ●●●.

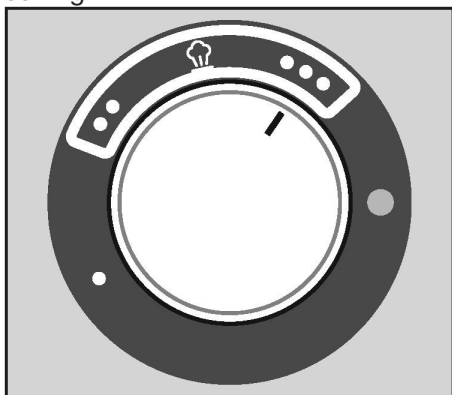

The indicator light on the temperature selector will light up yellow whilst the iron is heating up.

Useful tip: During the heating-up phase, you can set down the iron on the designated surface on the steam ironing system.

As soon as the indicator light goes out, the rinsing process is complete.

- Remove drops of water and deposits from the soleplate by moving the iron over a soft, absorbent cotton cloth while it is still hot. Press the  steam button briefly 2-3 times in the process.

The descaling process is now complete. The steam ironing system can now be switched off or used.

Cleaning the housing

 Before cleaning the housing, switch off at the socket and withdraw the plug.

Depending on the level of soiling, use a dry or moist soft cloth to wipe the housing.

Do not use abrasive cleaning agents.

Cleaning the soleplate of the iron

 The soleplate of the iron remains hot after ironing.

Danger of burning!

Switch off at the wall socket and withdraw the plug. Let the soleplate of the iron cool down before you start the cleaning process.

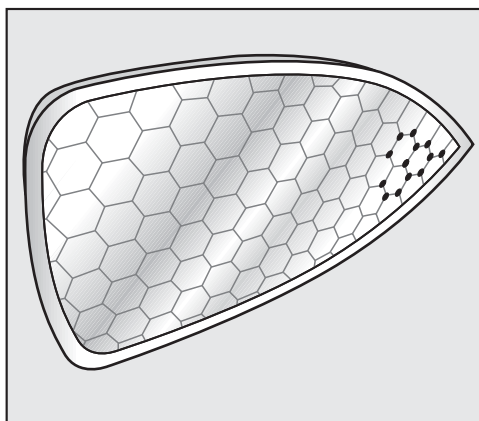

- Depending on the level of soiling, use a dry or moist microfibre cloth to clean the iron soleplate.

Only use the microfibre cloth to clean the iron soleplate!

- To avoid damaging the surface, **do not** use the following for cleaning:
 - abrasive cleaning agents, (e.g. powder cleaners, cream cleaners, chrome polish, eraser sponges).
 - hard, abrasive brushes or sponges, (e.g. pot scourers), or sponges which have been previously used and still contain abrasive cleaning agents.
 - pointed objects.

Cleaning or replacing the ironing board cover

If the ironing board cover is soiled, you can wash and dry it. If the ironing board cover is damaged, it must be replaced before using the steam ironing system again.

 When removing the ironing board cover, always ensure the steam ironing system is switched off and the plug is removed from the wall socket.

Wait until the ironing board has cooled down.

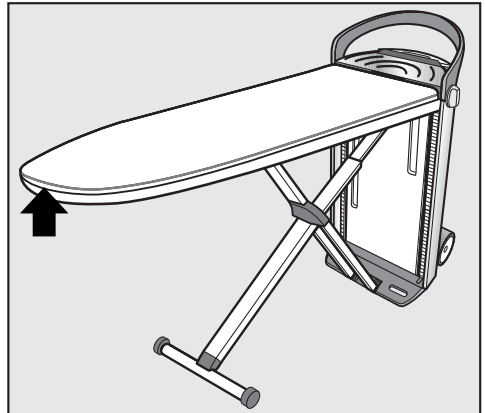

- Pull the fastener of the ironing board cover out of the cavity at the tapered end of the ironing board.
- Undo the fastener on the ironing board cover by pushing the small toothed wheel at the centre of the fastener outwards.
- Remove the cover in the direction of the tower.

The felt pad remains on the ironing board.

Cleaning and care

- Wash and dry the ironing board cover according to the care label or replace the cover if it is damaged.

Never use the steam ironing system without the ironing board cover in place.

- Put the dry or new cover onto the ironing board from the tower end first and draw it down towards the tapered end of the ironing board.
- Use the cord to pull the cover taut. Ensure the cover is secure.
- Secure the ironing board cover in position by pushing the small toothed wheel on the fastener to the middle.
- Push the fastener back into the cavity at the tip of the ironing board.

Cleaning the water filter

The water filter prevents foreign objects in the water from entering the steam ironing system and causing damage.

The water filter can be cleaned if it is dirty or clogged. You will notice if the water filter is dirty since this will cause more frequent pumping noises from the water feed pump.

Disconnect the power supply

- Switch off at the wall socket and withdraw the plug before cleaning the water filter.

Removing the water container

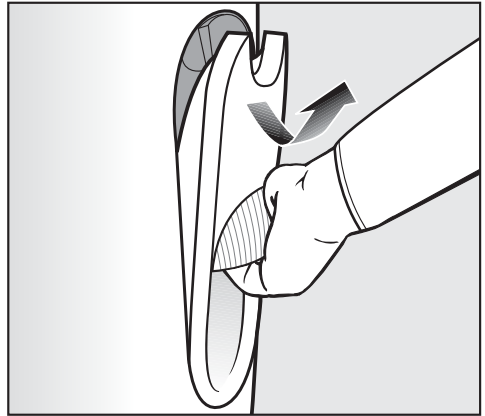

- Hold the water container by its handle.
- Pull the handle downwards.

The water container will release from the retainer.

- Pull the water container upwards and out.

Removing the water filter cover

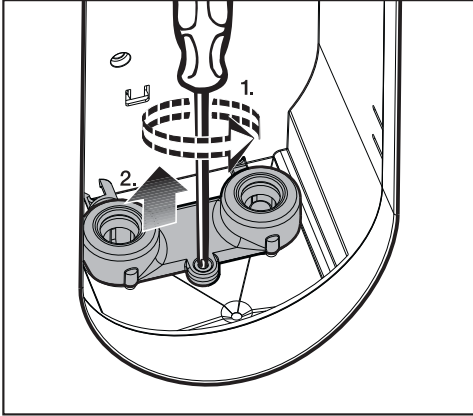

- Use a Phillips head screwdriver to remove the screw of the water filter cover.
- Pull the water filter cover upwards.

The water filter must be taken out of the right-hand socket for cleaning. There is a hook and a round tool at the sides of the water filter cover. Use these to remove the sealing ring from the socket and pull out the water filter.

Removing the sealing ring

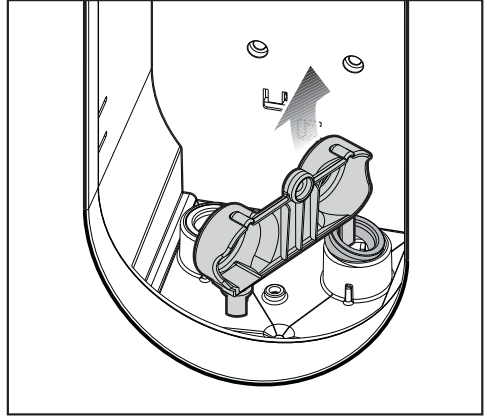

- Use the hook on the water filter cover to pull the sealing ring up and out of the right-hand socket.

Please note that the top of the sealing ring looks different to the bottom of it. The top has a smooth surface all round and the bottom has a narrow ridge around it. After cleaning the water filter, make sure that the seal is replaced with the ridge facing downwards.

Cleaning and care

Pulling out the water filter

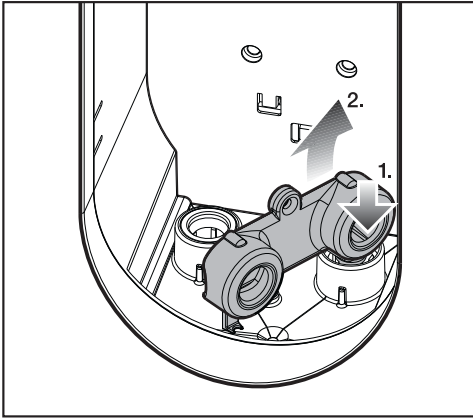

- Push the round tool on the water filter cover onto the water filter from above.

The round tool will click into the water filter.

- Pull the water filter out of the socket.

Cleaning the water filter

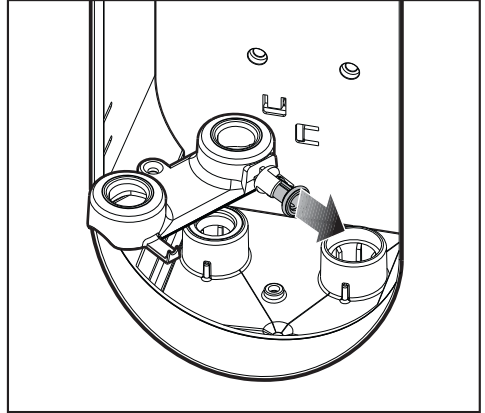

- Detach the water filter from the round tool.
- Clean the water filter thoroughly under running water.

Inserting the water filter

- Position the water filter with the small seal facing downwards.
- Press the water filter fully into the right-hand socket.
- Then refit the seal in the right-hand socket. The side with the ridge must face downwards.

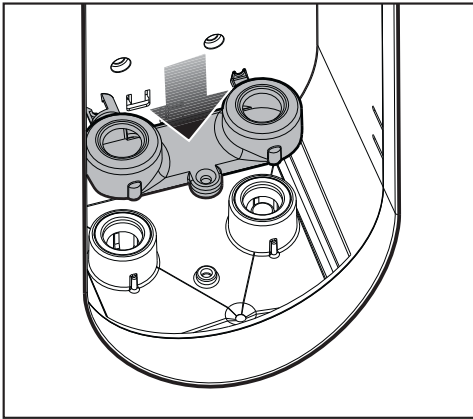

- Then refit the water filter cover over both sockets.

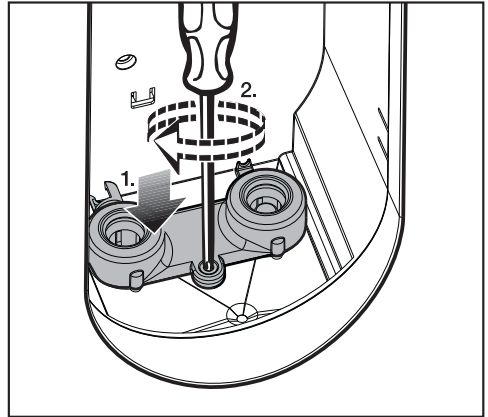

- Use a Phillips head screwdriver to tighten the screw.

Cleaning and care

Inserting the water container

- Refit the water container in the retainer in the tower.

The steam ironing system is now ready for operation again.

If the water filter is not inserted, the steam ironing system will not work.

The water filter must be replaced if it is worn or damaged. Replacement filters are available from Miele.

Miele appliances are designed to achieve the best possible results and to provide uncompromising satisfaction for as long as possible. To achieve this, all factors must interact perfectly with one another. Therefore Miele offers a comprehensive range of accessories that harmonise with Miele appliances for optimum performance.

The following items are just a few examples from our broad range of products and are available to order from shop.miele.com.

Care products

The Miele care product range has been developed specially to clean your appliance thoroughly and gently.

Descaling tablets

Miele descaling tablets guarantee the best cleaning result when descaling your Miele steam ironing system.

One tablet is required for each descaling process.

Problem solving guide

With the help of the following notes minor faults in the performance of the appliance, some of which may result from incorrect operation, can be corrected without contacting Miele. This will save time and money as a call-out charge will apply to customer service visits where the problem could have been rectified as described in these operating instructions.



 Repair work to electrical appliances should only be carried out by an authorised Miele service technician. Repairs and other work by unqualified persons could be dangerous. Miele cannot be held liable for unauthorised work.

Some of the messages in the display are more than one line long. Touch the ∨ or ∧ button to read them in full.

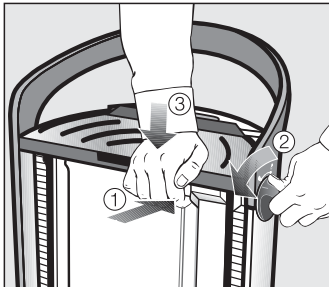

Problem solving guide

Problem	Possible cause and remedy
<p>The steam ironing system cannot be switched on.</p>	<p>The steam ironing system does not have any power.</p> <ul style="list-style-type: none"> ■ Check that <ul style="list-style-type: none"> – the plug is inserted into the wall socket and that the socket is switched on. – the circuit breaker has not tripped.
<p>After an interruption to the power supply, the steam ironing system does not work any more.</p>	<p>The steam ironing system is switched off.</p> <ul style="list-style-type: none"> ■ Use the Ⓜ button on the control panel to switch the steam ironing system on. <p>If the power cut occurred during the automatic rinse, the cycle will be repeated when the steam ironing system is switched on again.</p> <p>If the power cut occurred during descaling, the process will be resumed from the stage at which it was interrupted when the appliance is switched on again.</p>
<p>The height of the ironing board cannot be adjusted.</p>	<p>The ironing board is not locked into place on both sides of the tower.</p> <ul style="list-style-type: none"> ■ Use both hands to pull the ironing board up and into the horizontal position until the locking mechanism audibly clicks into place on both sides of the tower (see “Assembling”).
<p>The steam ironing system cannot be dismantled.</p>	<p>The steam ironing system is not in its lowest working position.</p> <ul style="list-style-type: none"> ■ Adjust the steam ironing system to its lowest working height (see “Dismantling”). <hr/> <p>The residual water drawer is not inserted completely and is not locked in place.</p> <ul style="list-style-type: none"> ■ Push the residual water drawer back into the tower until it locks into place. ■ Then adjust the steam ironing system to its lowest working height (see “Dismantling”).

Problem solving guide

Problem	Possible cause and remedy
The ironing board cannot be set in the final position during assembly or dismantling.	<p>The ironing board became dislodged from the latching mechanism when the board was not in its lowest position.</p>  <p>⚠ The resting surface of the iron remains hot after ironing. Danger of burning! Switch off at the wall socket and withdraw the plug. Let the iron and the resting surface cool down before removing the iron from the resting surface, and proceed with the following steps.</p> <ul style="list-style-type: none">■ Press and hold the release button on the tower (①).■ At the same time, turn one of the rotary dials on the side of the tower as far as it will go in the direction of  and hold the dial in this position (②).■ Push the tower down as far as possible (③).■ Then let go of the rotary dial on the side and subsequently release the unlocking button on the tower. <p>Now the ironing board can either be folded away or brought into its working position.</p> <ul style="list-style-type: none">■ If the ironing board still will not lock into place, contact Miele.
The iron does not heat up.	<p>The steam ironing system is switched off.</p> <ul style="list-style-type: none">■ Use the ① button on the control panel to switch the steam ironing system on. <p>The steam hose is not plugged in properly.</p>



Problem solving guide

Problem	Possible cause and remedy
	<p>■ Plug the steam hose into the steam connection socket on the tower again (see “Connecting”).</p> <p>The iron has not been used for some time.</p> <p>■ Move the iron or activate the steam button .</p> <p>The steam button  is locked.</p> <p>■ Unlock the steam button by pushing the sliding switch on the iron forwards.</p> <p>The temperature set on the temperature controller has already been reached.</p> <p>■ Set the temperature controller to a higher temperature, if necessary.</p> <p>The steam ironing system is rinsing.</p> <p>■ Wait until the rinsing process has been completed (see “Automatic rinsing”).</p> <p>The display is indicating a malfunction.</p> <p>■ Rectify the indicated malfunction and proceed as described on the following pages (see “Display messages”).</p> <p>The steam ironing system is damaged.</p> <p>■ Call Miele.</p>
<p>The ironing board is not heated.</p>	<p>Steam has not been used for a while.</p> <p>■ Press the steam button . This will activate the ironing board's heating system.</p> <p>The steamer is attached to the steam connection socket on the tower.</p> <p>■ The ironing board does not heat up when the steamer is connected.</p> <p>The ironing board is not locked into place on both sides of the tower.</p> <p>■ Ensure the ironing board locks into place on both sides of the tower (see “Assembling”).</p> <p>The steam ironing system is damaged.</p> <p>■ Call Miele.</p>
<p>The temperature of the iron is always high.</p>	<p>There is a fault with the steam ironing system.</p> <p>■ Call Miele.</p>

Problem solving guide

Problem	Possible cause and remedy
<p>The ironing board cover is damp.</p>	<p>There is a fault with the steam ironing system.</p> <ul style="list-style-type: none"> ■ Remove the ironing board cover and allow it to dry. ■ Put the dry ironing board cover back on (see “Cleaning or replacing the ironing board cover”). <p>If the ironing board gets damp again, contact Miele.</p>
<p>Water is leaking from the steam ironing system at the height of the water container when it is being transported.</p>	<p>The frequent removal and replacement of the water container may cause water droplets to collect in the area under the water container.</p> <ul style="list-style-type: none"> ■ Use a cloth to dry the area underneath the water container.
<p>The fan on the ironing board is not running.</p>	<p>Steam was not used.</p> <ul style="list-style-type: none"> ■ The fan only runs when the steam function on the iron is activated. <p>The appliance is not yet ready to produce steam.</p> <ul style="list-style-type: none"> ■ Wait until the message  Ready for use is displayed to indicate that steam is ready. <p>The water container is empty or not fitted.</p> <ul style="list-style-type: none"> ■ Fill the water container with fresh tap water and insert it into the appliance. <p>The steamer is connected.</p> <ul style="list-style-type: none"> ■ The fan only runs when the iron is connected. Connect the iron. <p>There is a fault with the steam ironing system.</p> <ul style="list-style-type: none"> ■ Call Miele.





Problem solving guide

Problem	Possible cause and remedy
<p>The steam function on the iron or the steamer is not working.</p>	<p>The steam ironing system is not connected to the wall socket.</p> <ul style="list-style-type: none"> ■ Insert the plug into the socket correctly. ■ Use the  button on the control panel to switch the steam ironing system on.
	<p>The iron or steamer is not connected.</p> <ul style="list-style-type: none"> ■ Attach the steam hose of the iron or the steamer to the steam connection socket on the tower.
	<p>The water container is empty or not fitted.</p> <ul style="list-style-type: none"> ■ Fill the water container with fresh water. ■ Fit the water container in the tower. ■ Wait until the message  Ready for use is displayed.
	<p>The appliance is not yet ready to produce steam.</p> <ul style="list-style-type: none"> ■ Wait until the message  Ready for use is displayed.
	<p>The display is indicating a malfunction.</p> <ul style="list-style-type: none"> ■ Rectify the indicated malfunction and proceed as described on the following pages (see “Display messages”). <p>If there is still no steam, contact Miele.</p>







Problem solving guide

Problem	Possible cause and remedy
When using the steam button  on the iron, drops of water or white deposits escape from the steam jets.	The selected temperature level on the iron is too low. ■ Set the temperature selector to at least ●● (see “Switching on - Selecting the ironing temperature”).
	The iron has not yet reached the selected temperature. ■ Wait until the selected ironing temperature has been reached (see “Switching on - Selecting the ironing temperature”).
	During a longer ironing break, condensation has accumulated in the steam hose. ■ After a break in ironing, do not direct the first burst of steam onto the garment.
	Deposits have formed in the soleplate. ■ Rinse the soleplate (see “Descaling process - Rinsing the soleplate”).









Display messages

Message	Possible cause and remedy
 Drain valve closing	<p>When the steam ironing system was switched on, the steam generator drain was open. The drain is closed automatically during this message.</p>
 Drain valve fault Switch off/on	<p>The descaling or rinsing process has not been carried out properly.</p> <ul style="list-style-type: none"> ■ Press the Ⓛ button to switch the steam ironing system off and then back on again. ■ If the fault message continues to be displayed, contact Miele.
 Memory fault Switch off/on	<p>There is a fault with the steam ironing system.</p> <ul style="list-style-type: none"> ■ Press the Ⓛ button to switch the steam ironing system off and then back on again. <p>The steam ironing system must now be reset.</p> <ul style="list-style-type: none"> ■ Complete the steps required when using for the first time (see “Before using for the first time”). ■ If the fault message continues to be displayed, contact Miele.
 Unplug at mains	<p>Electronic fault.</p> <ul style="list-style-type: none"> ■ Switch off at the wall socket and withdraw the plug. ■ Wait a while and then insert the plug back in the socket and switch on. ■ Press the Ⓛ button to switch the steam ironing system back on again. <p>The steam ironing system will try and rectify the fault itself.</p> <ul style="list-style-type: none"> ■ If the fault message continues to be displayed, switch off at the wall socket and withdraw the plug. Contact Miele.

Problem solving guide

Message	Possible cause and remedy
 Inlet fault, boiler Switch off/on	<p>There is a fault with the steam system.</p> <ul style="list-style-type: none"> ■ Press the  button to switch the steam ironing system off and then back on again. <p>After the cool-down phase, the steam ironing system will carry out a rinse and attempt to correct the fault itself. The cool-down phase can take up to 3 hours.</p> <ul style="list-style-type: none"> ■ Remove the residual water drawer if you are prompted to do so by the appropriate message in the display. ■ Empty and dry the residual water drawer. ■ Push the residual water drawer back in the tower until it clicks into place. <hr/> <p>There is a fault with the steam ironing system.</p> <ul style="list-style-type: none"> ■ If the fault message continues to be displayed, contact Miele.
 Press. switch fault Switch off/on	<p>There is a fault with the steam system.</p> <ul style="list-style-type: none"> ■ Press the  button to switch the steam ironing system off and then back on again. ■ If the fault continues to be displayed, contact Miele.
 Boiler fault, warm Switch off/on	<p>There is a fault with the steam ironing system.</p> <ul style="list-style-type: none"> ■ Press the  button to switch the steam ironing system off and then back on again. ■ If the fault continues to be displayed, contact Miele. <hr/> <p>The steam generator is soiled with water containing too much limescale or salt.</p> <ul style="list-style-type: none"> ■ Start a descaling process (see “Starting the descaling process early”). To avoid this problem in the future, the preset water hardness level can be set one level higher (e.g. from to , see “Setting the water hardness”). ■ If the fault continues to be displayed, contact Miele.

Problem solving guide

Message	Possible cause and remedy
 Boiler fault, cold Switch off/on	<p>There is a fault with the steam ironing system.</p> <ul style="list-style-type: none"> ■ Press the  button to switch the steam ironing system off and then back on again. ■ If the fault continues to be displayed, contact Miele.
 Release stm. button	<p>The iron has switched itself off because it has not been used for a period of time and the steam button  has locked.</p> <ul style="list-style-type: none"> ■ Unlock the steam button  by pushing the sliding switch for continual steam on the iron forwards.
 Drain valve fault Switch off/on	<p>The residual water drawer has not been detected.</p> <ul style="list-style-type: none"> ■ Press the  button to switch the steam ironing system off and then back on again.
	<p>After switching the steam ironing system off and back on, the residual water drawer is not detected.</p> <ul style="list-style-type: none"> ■ Press the  button to switch the steam ironing system off. ■ Clean and dry the metal discs (contacts) on the residual water drawer. ■ Use the  button to switch the steam ironing system back on and follow the instructions shown in the display: ■ Remove the residual water drawer and fill it with fresh tap water. ■ Fit the filled residual water drawer back in the tower. ■ Remove the residual water drawer again when you are prompted to do so and the appropriate messages are shown in the display. ■ Empty and dry the residual water drawer. ■ Fit the empty residual water drawer back in the tower. <p>The steam ironing system is now ready for operation and will continue to operate from the point reached before the fault was registered.</p>
	<p>There is a fault with the steam ironing system.</p> <ul style="list-style-type: none"> ■ If the fault message continues to be displayed, contact Miele.

Problem solving guide

Message	Possible cause and remedy
Fault codes: F38: ELP/EW/LNG F44 F45: LNG F47	There is an internal fault. ■ Press the ⓪ button to switch the steam ironing system off and then back on again. The steam ironing system will try and rectify the fault itself. If the fault message continues to be displayed, contact Miele.

After sales service

In the event of a fault which you cannot correct yourself, please contact Miele.

The contact details for Miele are given at the back of these instructions.

When contacting Miele please quote the **model** and **serial number** of your appliance.

This information can be found on the data plate which is located on the tower behind the water container.

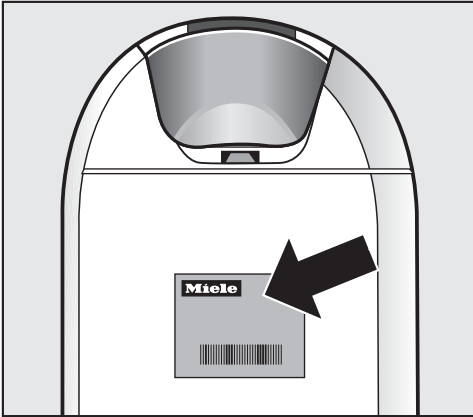

Warranty

The manufacturer's warranty for this appliance is 2 years.

For further information, please refer to your warranty booklet.

Electrical connection

Before you connect the steam ironing system to the electricity supply, you must check the connection data (voltage and frequency) on the data plate and compare it with the data applicable to your local power supply.

This data must match, otherwise there is a risk of damage to the steam ironing system.

If in doubt, consult a suitably qualified electrician.

You will find the necessary connection data on the data plate, which is located in the tower behind the water container.

The steam ironing system is supplied with a cable and moulded plug ready for use with an alternating current of 50-60 Hz, 220-240 V. Connect the steam ironing system only to a properly installed and compliant earthed socket. All electrical work must be carried out by a suitably qualified and competent person in accordance with current local and national safety regulations.

The fuse must have a rating of at least 10 A. For extra safety, we recommend protecting the appliance with a 30 mA residual current device (RCD).

The socket should be next to the appliance and easily accessible.

If the mains connection cable is faulty, it must only be replaced by a suitably qualified electrician.

Do not use a multi-socket adapter or an extension lead to connect the steam ironing system to the power supply.

Extension leads or multi-socket adapters do not guarantee the required safety of the steam ironing system (e.g. danger of overheating).

Do not connect the steam ironing system to an off-grid inverter. These devices are used for autonomous power supply, e.g. a solar power system.

Power surges could cause a safety cut-out. This could damage the electronics.

Do not use the steam ironing system with so-called "energy saving plugs". These reduce the energy supply to the appliance, which could generate excessive heat.

Technical data

Dimensions, folded (H x W x D)	1280 x 470 x 370 mm
Assembled dimensions (H x W x D)	970 x 470 x 1480 mm
Weight	29 kg
Voltage	See data plate
Total rated load	See data plate
Fuse rating	≥ 10 A
Steam pressure for B 3312	3.5 bar
Steam pressure for B 3826 and B 3847	4.0 bar
Steam quantity	100 g/min
Capacity of water container	1.25 l
Length of mains connection cable	2.50 m
Length of steam hose	1.80 m
Height of ironing board	830-1020 mm
Length of ironing board	1200 mm
Width of ironing board	400 mm
Product safety standard	in accordance with AS/NZS 60335-1, AS/NZS 60335-2-3
Test certificates awarded	See data plate







Miele Australia Pty. Ltd.

ACN 005 635 398
ABN 96 005 635 398

**Miele Experience Centre and
Head Office Melbourne:**

1 Gilbert Park Drive
Knoxfield, VIC 3180

Miele Experience Centre South Melbourne:

206-210 Coventry Street
South Melbourne, VIC 3205

Miele Experience Centre and Office Sydney:

3 Skyline Place
Frenchs Forest, NSW 2086

Miele Experience Centre and Office Brisbane:

Tenancy 4C, 63 Skyring Terrace
Newstead, QLD 4006

Miele Experience Centre Gold Coast:

131 Ferry Road
Southport, QLD 4215

Miele Experience Centre and Office Adelaide:

83-85 Sir Donald Bradman Drive
Hilton, SA 5033

Miele Experience Centre and Office Perth:

205-207 Stirling Highway
Claremont, WA 6010

1300 464 353 (1300 4 MIELE)

www.miele.com.au

Miele New Zealand Limited

IRD 98 463 631

Head Office:

Level 2, 10 College Hill
Freemans Bay, Auckland 1011

**Miele Experience Centre
Auckland:**

8 College Hill
Freemans Bay, Auckland 1011

**Miele Experience Centre
Wellington:**

183 Featherston Street
Wellington 6011

0800 464 353 (0800 4 MIELE)

www.miele.co.nz

Miele Global Headquarters

Germany

Miele & Cie. KG

Carl-Miele-Straße 29

33332 Gütersloh

Federal Republic of Germany

FashionMaster

en-AU,NZ

M.-Nr. 10 675 001 / 01