

Operating and installation instructions Cooker hood



To prevent the risk of accidents or damage to the appliance, it is **essential** to read these instructions before it is installed and used for the first time.

Contents

Warning and Safety instructions	4
Caring for the environment	13
Guide to the cooker hood	14
Modes of operation	16
Before using for the first time	17
Selecting extraction mode or recirculation mode.....	17
Setting up Miele@home	17
Connecting via the app	18
Connecting via WPS	19
Sign out of WiFi (reset to factory settings)	20
Setting up Con@ctivity	21
Con@ctivity via the home WiFi network (Con@ctivity 3.0)	22
Con@ctivity via a direct WiFi connection (Con@ctivity 3.0)	22
Operation (Automatic mode)	24
Cooking with Con@ctivity (Automatic mode)	24
Cooking process	25
Leaving automatic mode temporarily	26
Returning to automatic mode.....	26
Operation (Manual mode)	27
Cooking without Con@ctivity (Manual mode)	27
Switching the fan on.....	27
Selecting the power level	27
Selecting the run-on time	27
Switching the fan off	27
Dimming/switching the hob lighting on/off	28
Power management	28
Safety switch-off	29
Operation (Automatic and Manual modes)	30
Operating hours counter	30
Altering the operating hours counter for the grease filter(s)	30
Altering or deactivating the charcoal filter operating hours counter	31
Reading the filter operating hours counter.....	31
Energy saving tips	32
Cleaning and care	33
Housing	33
Grease filters and panel for edge extraction	34

Charcoal filters	37
Resetting the charcoal filter operating hours counter	38
Disposing of charcoal filters	38
Installation	39
Before installation.....	39
Appliance dimensions	40
Safety distance between hob and cooker hood (S)	42
Installation recommendations	43
Installation materials.....	43
Uneven installation surfaces	44
Connection for air extraction	45
Non-return flap	46
Condensation	46
Silencer.....	47
Electrical connection	48
Service	49
Contact in the event of a fault	49
Position of the data plate	49
Warranty	49
Technical data	50
Special accessories for recirculation mode	50
Conformity declaration	51

Warning and Safety instructions

This cooker hood complies with all relevant local and national safety requirements. Inappropriate use can, however, lead to personal injury and material damage.

Read the operating and installation instructions carefully before using the cooker hood. They contain important information on its safety, installation, use and maintenance. This prevents both personal injury and damage to the cooker hood.

In accordance with standard IEC 60335-1, Miele expressly and strongly advises that you read and follow the instructions in the chapter on installing the appliance as well as the safety instructions and warnings.

Miele cannot be held liable for injury or damage caused by non-compliance with these instructions.

Keep these instructions in a safe place and pass them on to any future owner.

Correct application

▶ This cooker hood is intended for use in domestic households and similar working and residential environments.

▶ The cooker hood is not intended for outdoor use.

▶ It must only be used as a domestic appliance to extract vapours and remove odours from cooking.

Any other usage is not supported by the manufacturer and could be dangerous.

▶ Where a recirculation cooker hood is fitted above a gas hob, please ensure that there is an adequate supply of fresh air into the room in which it is installed. Please seek the advice of a qualified gas fitter (e.g. GasSafe in the UK) for more information if necessary.

Warning and Safety instructions

▶ The cooker hood can only be used by people with reduced physical, sensory or mental capabilities, or lack of experience and knowledge, if they are supervised whilst using it, or have been shown how to use it in a safe way and recognise and understand the consequences of incorrect operation.

Safety with children

- ▶ Children under 8 years of age must be kept away from the cooker hood unless they are constantly supervised.
- ▶ Children aged 8 and older may only use the cooker hood without supervision if they have been shown how to use it and are able to do so in a safe manner. Children must be able to understand and recognise the possible dangers caused by incorrect operation.
- ▶ Children must not be allowed to clean or maintain the cooker hood unsupervised.
- ▶ Please supervise children in the vicinity of the cooker hood and do not let them play with it.
- ▶ The hob lighting is very intensive.
Ensure, in particular, that babies/small children do not look at the light.
- ▶ Danger of suffocation! Whilst playing, children may become entangled in packaging material (such as plastic wrapping) or pull it over their head with the risk of suffocation. Keep packaging material away from children.

Warning and Safety instructions

Technical safety

- ▶ Unauthorised installation, maintenance and repairs can cause considerable danger for the user. Installation, maintenance and repairs must only be carried out by a Miele authorised technician.
- ▶ A damaged appliance can be dangerous. Check it for visible signs of damage. Do not use a damaged appliance.
- ▶ The electrical safety of this appliance can only be guaranteed when correctly earthed. It is essential that this standard safety requirement is met. If in any doubt please have the electrical installation tested by a qualified electrician.
- ▶ Reliable and safe operation of this cooker hood can only be assured if it has been connected to the mains electricity supply.
- ▶ The connection data (voltage and frequency) on the data plate of the cooker hood must match the mains electricity supply in order to avoid the risk of damage to the cooker hood
Compare this before connecting the appliance to the mains. Consult a qualified electrician if in any doubt.
- ▶ Do not connect the appliance to the mains electricity supply by a multi-socket unit or an extension lead. These are a fire hazard and do not guarantee the required safety of the appliance.
- ▶ EXT/EXTA model cooker hoods are connected to their external motor using a special connection cable and plug connectors. These appliances may only be combined with a Miele external motor.

Warning and Safety instructions

- ▶ For safety reasons, this appliance may only be used after it has been built in.
- ▶ The cooker hood must not be used in a non-stationary location (e.g. on a ship).
- ▶ Touching electrical components and tampering with electrical and mechanical parts is highly dangerous to the user and can cause operational faults.
Only open the housing as described in the instructions given in the installation sheet and in the Cleaning and care section of this booklet. Under no circumstances should any other parts of the housing be opened.
- ▶ The manufacturer's warranty will be invalidated if the appliance is not repaired by a Miele authorised technician.
- ▶ Miele can only guarantee the safety of the appliance when genuine original Miele replacement parts are used. Faulty components must only be replaced by Miele spare parts.
- ▶ If the electrical connection cable is faulty it must only be replaced by a Miele authorised technician to protect the user from danger.
- ▶ During installation, maintenance and repair work, the appliance must be disconnected from the mains electricity supply.

Warning and Safety instructions

Using at the same time as another heating appliance that depends on the air from the room

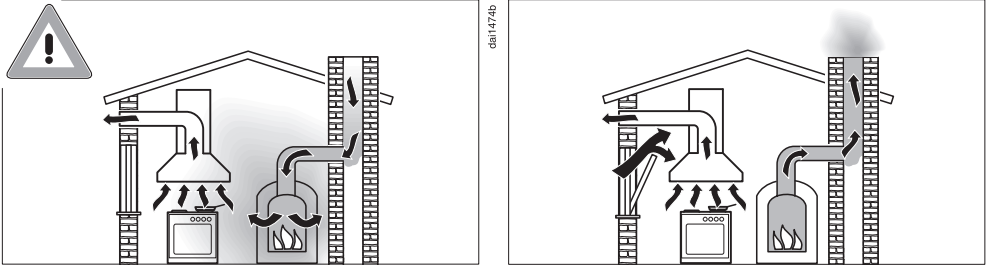

Danger of toxic fumes!

Great care should be taken when using the cooker hood in the same room or the same area of the house at the same time as another heating appliance that depends on the air from the room. Such heating appliances draw in air from the room and duct exhaust gases out through a chimney or extraction ducting. They include gas, oil, wood and coal-fired boilers and heaters, continuous flow or other water heaters, gas hobs and ovens.

The cooker hood draws in air from the kitchen and from neighbouring rooms. This applies to the following modes of operation:

- extraction mode
- extraction mode with an external motor
- recirculation mode with a recirculation box installed outside the room

If there is insufficient air, negative pressure will occur. The heating appliance may be starved of oxygen. This impairs combustion. Harmful gases could be drawn from the chimney or extraction ducting back into the room.

Risk of death!

Warning and Safety instructions

In order to ensure safe operation and to prevent gases given off by the heating appliance from being drawn back into the room when the cooker hood and the heater are both operated simultaneously, an underpressure in the room of 0.04 mbar (4 Pa) is the maximum permissible.

Sufficient ventilation can be maintained by air inlets which cannot be blocked, e.g. in windows, doors and outside wall vents. The cross-section of the inlet openings must enable sufficient ventilation. A ventilation brick alone is not generally sufficient to ensure safe ventilation.

The overall ventilation condition of the dwelling must be taken into account. If in any doubt, seek the advice of a competent building regulations inspector or qualified gas fitter (GasSafe in the UK).

If the cooker hood is being operated in recirculation mode, whereby the air is redirected into the room in which it is installed, the above restrictions do not apply.

Warning and Safety instructions

Correct use

▶ Open flames are a fire hazard.

The use of an open flame under the cooker hood is not permitted. To avoid the danger of fire, do not flambé or grill over an open flame.

When switched on, the cooker hood could draw flames into the filter. Fat deposits could ignite, presenting a fire hazard.

▶ The cooker hood can become damaged when exposed to excessive heat.

- When using the cooker hood over a gas hob, ensure that any burners in use are always covered by a pan. Switch the cooking zone off when a pan is removed, even for a short time.
- Select a pan which is suitable for the size of the burner.
- Regulate the flame so that it does not burn up the sides of the pan.
- Avoid overheating the pan (e.g. when cooking with a wok).

▶ Always switch the cooker hood on when a cooking zone is in use, otherwise condensation may collect in the hood, which could cause corrosion.

▶ Overheated oil and fat can ignite, causing fire damage to the cooker hood.

When cooking with oil or fat, chip pans and deep fat fryers, etc, do not leave the pans unattended. Similarly, never leave an open grill unattended when grilling.

Warning and Safety instructions

▶ Do not use the cooker hood without the filters in place. This way you will avoid the risk of grease and dirt getting into the appliance and hindering its smooth operation.

▶ The cooker hood can get very hot during cooking due to heat rising from the hob.

Do not touch the housing or the grease filters until the cooker hood has cooled down.

Proper installation

▶ Refer to the cooker or hob manufacturer's instructions as to whether a cooker hood may be operated above the cooker/hob.

▶ Safety regulations prohibit the fitting of a cooker hood over solid fuel stoves.

▶ An insufficient safety distance between the hob and the cooker hood can result in damage to the cooker hood.

The minimum safety distances between the top of the hob and the bottom of the cooker hood given in the “Installation” section of this manual must be observed, unless the hob manufacturer states that a greater safety distance is required.

If more than one cooking appliance is fitted beneath the cooker hood, and they have different minimum safety distances to the cooker hood, select the greater distance.

▶ The information provided in “Installation” must be observed when fixing the ventilation hood.

▶ Components can have sharp edges which may cause injury. Wear gloves to protect your hands from being cut.

▶ Exhaust ducting must be of non-flammable material. Suitable material is available from Miele specialist dealers or the Miele Spares Dept.

▶ The appliance must not be connected to a chimney or flue which is in use. Neither should it be connected to ducting which ventilates rooms with fireplaces.

Warning and Safety instructions

▶ If exhaust air is to be extracted into a chimney or ventilation duct no longer used for other purposes, seek professional advice.

Cleaning and care

▶ There is a risk of fire if the cooker hood is not cleaned as described in these operating instructions.

▶ Do not use a steam cleaning appliance to clean this appliance. The steam could reach electrical components and cause a short circuit.

Accessories

▶ Only use genuine original Miele accessories and spare parts with this appliance. Using accessories or spare parts from other manufacturers will invalidate the warranty and Miele cannot accept liability.

Disposal of the packing material

The packaging is designed to protect the appliance from damage during transportation. The packaging materials used are selected from materials which are environmentally friendly for disposal and should be recycled.

Recycling the packaging reduces the use of raw materials in the manufacturing process and also reduces the amount of waste in landfill sites.

Disposing of your old appliance

Electrical and electronic appliances often contain valuable materials. They also contain specific materials, compounds and components, which were essential for their correct function and safety. These could be hazardous to human health and to the environment if disposed of with your domestic waste or if handled incorrectly. Please do not, therefore, dispose of your old appliance with your household waste.



Please dispose of it at your local community waste collection / recycling centre for electrical and electronic appliances, or contact your dealer or Miele for advice. You are also responsible for deleting any personal data that may be stored on the appliance being disposed of. Please ensure that your old appliance poses no risk to children while being stored prior to disposal.

Guide to the cooker hood

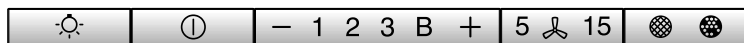
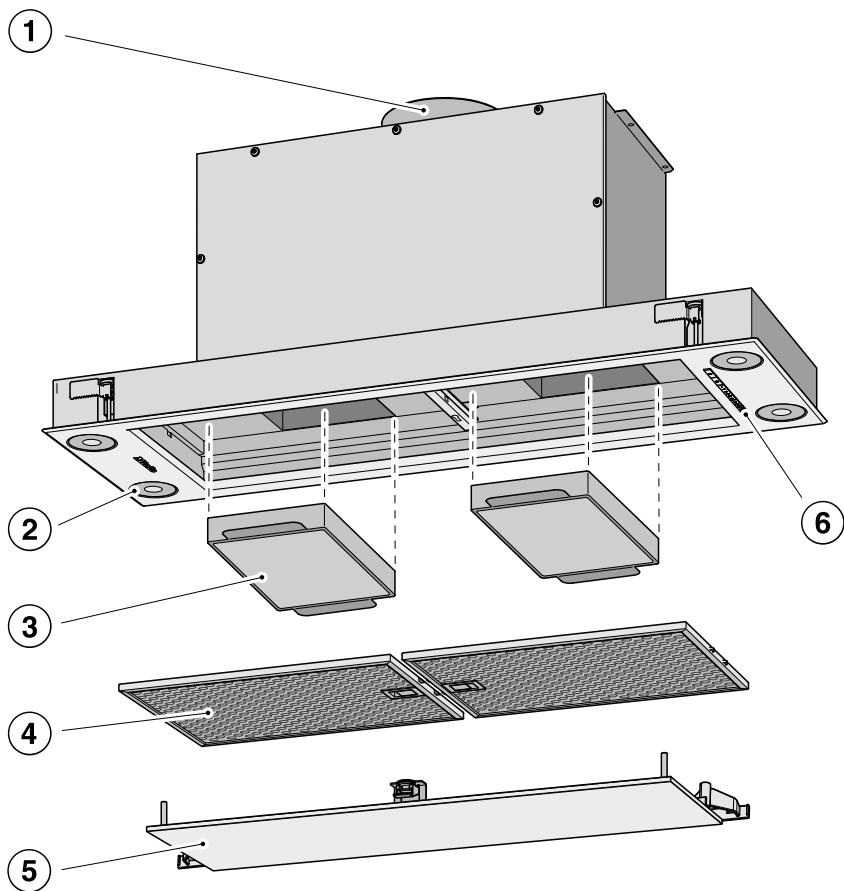

7

8

9

10

11

- ① Exhaust duct
Exhaust air can be directed through the back of the cooker hood or upwards to the ceiling.
- ② Hob lighting
- ③ Charcoal filter
Optional accessories for recirculation mode
DA 2668, DA 2698 only
- ④ Grease filter
DA 2668, DA 2698: x 1,
DA 2628: x 2
- ⑤ Edge extraction panel
DA 2668, DA 2698: x 1,
DA 2628: x 2
- ⑥ Control elements
- ⑦ Control for switching the lighting on and off and for dimming the lighting
- ⑧ Control for switching the fan on and off
- ⑨ Controls for setting the fan power level
- ⑩ Control for the run-on function
- ⑪ Control for the operating hours counter

Modes of operation

Depending on the model of the cooker hood, the following options are available:

Extraction mode



The cooking vapours are drawn in by the cooker hood. The air is then passed via the edge extraction panel through the grease filters, cleaned and then directed outside.

Recirculation mode



The air is drawn in and passed via the edge extraction panel through the grease filters and then through 2 charcoal filters. The cleaned air is then recirculated back into the kitchen.

DA 2628 cannot be used as a recirculation mode cooker hood.

Operation with an external motor

(EXT/EXTA model cooker hoods)

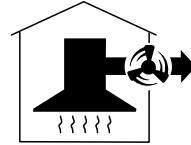

Cooker hoods designed for use with an external motor have to be connected to a Miele external motor located in a position of your choice outside the room. The external motor is connected to the cooker hood by means of a control cable and is operated via Con@ctivity or by the control elements on the cooker hood.

da10494a



da10494b

da10494c



Selecting extraction mode or recirculation mode

The cooker hood is suitable for both extraction mode and recirculation mode. The power of the fan is adapted to suit the selected operating mode. The cooker hood is delivered set up for recirculation mode. It has to be reset for extraction mode.

To reset it for extraction mode, the operating hours counter for the charcoal filter(s) has to be deactivated.

- Switch off the fan and the lighting.
- Press the + control and the operating hours control   at the same time.

The charcoal filter symbol  and one of the fan power levels will flash.

- Press and hold the + control until the **B** indicator starts to flash.
- Confirm your choice with the operating hours control  .

All the indicator lights will go out.

Extraction mode has now been set.

If you do not confirm your selection within 4 minutes, the cooker hood will automatically revert to the original setting.

Setting up Miele@home

Requirements:

- A WiFi network
- The Miele app
- A Miele user account. The user account can be created via the Miele app.

Your cooker hood is equipped with an integrated WiFi module. Connect the cooker hood to your household WiFi network. You will then be able to operate the cooker hood via the Miele app.

If your Miele hob is connected to a home WiFi network, you can control the cooker hood automatically via the Con@ctivity function.

Before installing the cooker hood in its final location, ensure that the signal of your WiFi network is strong enough.

You can connect to the household WiFi network via the Miele app or via WPS.

Before using for the first time

Miele@home availability

The ability to use the Miele app depends on the availability of the Miele@home service in your country.

The Miele@home service is not available in every country.

For information about availability, please visit www.miele.com.

Miele App

The Miele App is available to download free of charge from the Apple App Store® or from the Google Play Store™.



Connecting via the app

The Miele app can be used to connect to your network.

- Install the Miele app on your mobile device.

For the registration, you will need:

1. Your WiFi network password
2. Your cooker hood password



The password for your cooker hood consists of the last 9 digits of the serial number. This can be found on the appliance's data plate.

The data plate is visible after removing the grease filter(s).



- Start signing the appliance on in the app. Follow the signing-on instructions.

If requested to activate WiFi on the cooker hood, proceed as follows:

Before using for the first time

- Switch the cooker hood off.



- Press and hold the + control.



- Press the lighting control at the same time .

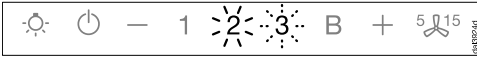

2 will light up constantly, **3** will flash on and off.

The cooker hood will be ready for connection in the next 2 minutes.



- Follow the instructions in the app.

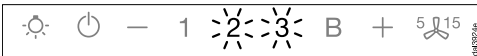

When successfully connected, **2** and **3** will light up constantly.



- Quit connection mode on the cooker hood by pressing the run-on control .

The cooker hood can now be operated via the app.

Connecting via WPS

Your WiFi router must support WPS (WiFi Protected Setup).

- Switch the cooker hood off.



- Press and hold the + control.



- Press the lighting control at the same time .

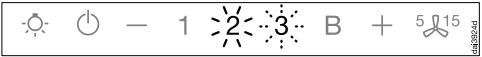

2 will light up constantly, **3** will flash on and off.

The WiFi connection must be started on the cooker hood at the same time as on the WiFi router.

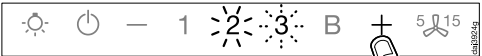

- Press the + control on the cooker hood after a few seconds.

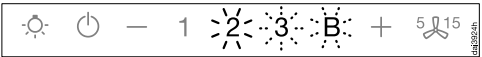

After a short while the **2** will light up constantly, and the **3** and the **B** will flash on and off.

The cooker hood is ready for connection in the next two minutes.

Before using for the first time



- Start the WiFi connection on your WiFi router.



When successfully connected the **2** and **3** will light up constantly.



- Quit connection mode on the cooker hood by pressing the Run-on control **5** and **15**.

The cooker hood can now be operated via the app.

If the connection fails, you have probably not connected WPS on your router quickly enough. Repeat the steps above.

Tip: If your WiFi router does not support WPS, please connect via the Miele app.

Sign out of WiFi (reset to factory settings)

To set up a new WiFi connection, the existing WiFi connection must be disconnected.

- Switch the cooker hood off.



- Press and hold the **–** control.



- Touch the lighting control at the same time .



With an existing WiFi connection, **2** and **3** will light up constantly.

The cooker hood will be ready for disconnection in the next 2 minutes.

Before using for the first time



- Touch the — control.

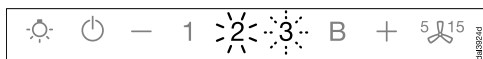

2 will light up constantly, **3** will flash on and off.

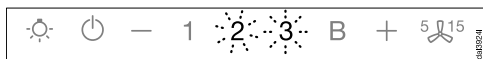

After a few seconds, **2** and **3** will flash on and off. The connection has now been disconnected.



- Quit signing-off mode on the cooker hood by pressing the run-on control ⁵ ¹⁵.

The WiFi connection has now been disconnected. A new connection can now be set up.

Setting up Con@ctivity

Con@ctivity is the direct communication system between an electric Miele hob and a Miele cooker hood. It enables the cooker hood to operate automatically depending on the operational state of a Miele hob with onset controls.

- When the hob is switched on, the cooker hood lighting comes on automatically and then after a short time the fan also comes on.
- The cooker hood selects the power level automatically during cooking. The power level selected by the cooker hood depends on the number of cooking zones being used and their power levels.
- After switching the hob off the fan and the hob lighting will switch off automatically after a specified period of time.

See “Operation” for detailed information about this function.

Before using for the first time

Con@ctivity via the home WiFi network (Con@ctivity 3.0)

Prerequisite:

- Home WiFi network
- WiFi-enabled Miele hob

■ Connect the cooker hood and hob to your home WiFi network (see “Setting up Miele@home”).

The Con@ctivity function will be activated automatically.

Con@ctivity via a direct WiFi connection (Con@ctivity 3.0)

Prerequisite:

- WiFi enabled Miele hob

If you do not have a home network, you can establish a direct connection between the hob and the cooker hood.

See the Hob instruction manual for details on how to connect them.

Instructions on how to connect the cooker hood are repeated in detail below.

■ Switch the cooker hood off.



■ Press and hold the + control.



■ Press the – control at the same time.

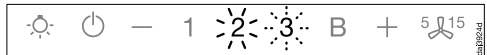

2 will light up constantly, **3** will flash on and off.

The cooker hood will be ready for connection in the next 2 minutes.

Before using for the first time

- Start WiFi connection on the hob. For further details, see the hob operating instructions.

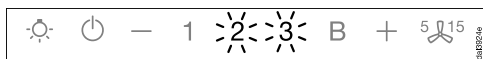

When successfully connected, **2** and **3** will light up constantly.



- Quit connection mode on the cooker hood by pressing the run-on control ⁵15.

Con@ctivity has now been activated.

With a direct WiFi connection, it is not possible to connect the hob and the cooker hood to a home network. Should this be required at a later date, the WiFi connection between the hob and the cooker hood must be disconnected (see “Sign out of WiFi”).

Operation (Automatic mode)

When Con@ctivity is active, the cooker hood always operates in automatic mode (see “Before using for the first time” – “Setting up Con@ctivity”).

If you wish to manually operate the cooker hood, see “Operation (Manual mode)” – “Cooking without Con@ctivity”.

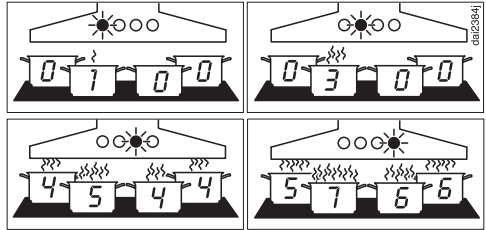

Examples for power levels **1 to B**

Cooking with Con@ctivity (Automatic mode)

- Switch a cooking zone on at the desired power level.

The hob lighting will come on.

After a few seconds the fan will come on, first at power level **2**, then it will switch immediately to power level **1**.

The cooker hood selects the fan power level automatically during cooking.

This is determined by the total output of the hob, i.e. the number of cooking zones in operation and the power levels selected.

If you select a higher power level or are using several cooking zones, the cooker hood will switch to a higher fan power level.

When you reduce the power level or the number of cooking zones on the hob, the fan power level is also reduced.

Reaction time

The cooker hood reacts with a slight delay because altering the power level on the hob does not immediately result in a reduction or increase in cooking vapours.

Because the hob transmits the information to the cooker hood at intervals, this can also cause delays.

The reaction can vary from a few seconds to a couple of minutes.

Cooking process

- For example, you switch on a cooking zone at the highest power level to heat a pan for frying. You reduce the power level after approx. 10 seconds to 4 minutes (60 seconds to 5 minutes for a HiLight hob).

The cooker hood recognises a cooking process.

The cooker hood switches itself on and when the hob power level has been reduced, the hood switches to fan power level 3 and remains at that level for approx. 5 minutes.

After that, the cooker hood power level is determined automatically by the Con@ctivity function.

You can select another power level manually before then.

Switching off

- Switch off all cooking zones.

The cooker hood fan will reduce its power level in stages over the next few minutes and will then switch itself off.

This helps to neutralise any lingering vapours and odours in the air.

- From the Booster setting, the fan switches immediately to Level 3.
- From Level 3, it will switch to Level 2 after approx. 1 minute.
- From Level 2, it will switch to Level 1 after 2 minutes.
- After 2 minutes at Level 1 the fan switches itself off.
- After another 30 seconds, the hob lighting switches off.

The cooking process is then finished.

Operation (Automatic mode)

Leaving automatic mode temporarily

To leave automatic mode temporarily during cooking:

- Manually select a different fan power level, or
- Manually switch the cooker hood off, or
- Activate the run-on function  on the cooker hood. The fan will switch itself off after the selected run-on time, and the lighting will remain on.

The cooker hood functions are now operated manually (see “Operation (Manual mode)”).

Returning to automatic mode

The cooker hood will resume automatic mode:

- If the cooker hood has not been used for approx. 5 minutes after selecting a fan power level manually, or
- If the manually selected fan power level corresponds to the automatic one again, or
- The cooker hood fan and the hob have been switched off for at least 30 seconds.
Automatic mode will resume next time the hob is switched on.

You can also operate the cooker hood manually for a complete cooking process.

- Switch the cooker hood fan on **before** the hob.

If the cooker hood fan and the hob have been switched off for at least 30 seconds after cooking, automatic mode will resume next time the hob is switched on.

Cooking without Con@ctivity (Manual mode)

The cooker hood can be operated manually if:

- The Con@ctivity function is not activated.
- You have temporarily deactivated the Con@ctivity function (see “Operation (Manual operation)” – “Leaving automatic mode temporarily”).

Switching the fan on

Switch the fan on as soon as you start cooking. This is to ensure that vapours are captured right from the start.

- Press the On/Off control .

The fan will switch on at setting **2** and the  symbol and **2** will light up in the power setting display.

Selecting the power level

For light to heavy cooking vapours and odours, select from power levels **1** to **3**.

For short periods of cooking food with intensive vapours and a strong aroma, e.g. when searing meat, select Booster setting **B**.

- Select the power level you want by pressing the – or + control.

Reducing power down from the Booster setting



If power management is activated (default setting), the fan automatically switches back to level **3** after 5 minutes.

Selecting the run-on time

It is advisable to run the fan for a few minutes after cooking has finished. This helps to remove any lingering vapours and odours from the air.

It also reduces the risk of residues accumulating in the cooker hood and any resultant odours.

The run-on function enables the fan to continue running for a pre-determined time before switching itself off automatically.

- After you have finished cooking, press the run-on control  while the fan is still running:
 - Once: the fan will switch itself off after 5 minutes (**5** lights up).
 - Twice: The fan will switch itself off after 15 minutes (**15** lights up).
 - If you touch the run-on option control  again, the fan will remain on ( will go out).

Switching the fan off

- Press the On/Off control  to switch the fan off.

The  symbol will go out.



Operation (Manual mode)

Dimming/switching the hob lighting on/off

The hob lighting can be switched on and off and dimmed independently of the fan.

- Press the lighting sensor  briefly to switch it on or off.

The lighting will switch on at maximum brightness.

- With the lighting switched on, press and hold the hob lighting control . The brightness will gradually dim until you release the control.
- Press and hold the lighting  control again to increase the brightness to the level required and then release it.

Power management



The cooker hood is fitted with a power management system. Power management helps to save energy. It ensures that the fan power level is reduced automatically and that the lighting is switched off.

- If the Booster setting has been selected, the fan will automatically switch to level 3 after 5 minutes.
- From fan power levels 3, 2 or 1, the power will be reduced by one level after 2 hours and then in 30-minute stages until the fan finally switches off.
- The hob lighting will switch off automatically after 12 hours.

You can deactivate power management.

Keep in mind that deactivating this function may increase energy consumption.

Activating/deactivating Power Management

- Switch off the fan and the lighting.
- Press the fan run-on control  for approx. 10 seconds until the indicator for fan power level **1** lights up.
- Then press in turn:
 - the lighting control ,
 - the **—** control, and then
 - the lighting control .

If Power Management is activated, the **1** and **B** indicators light up constantly. When it is deactivated, the **1** and **B** indicators flash.

- Press the — control to deactivate Power Management.

The **1** and **B** indicators will flash.

- Press the + control to activate Power Management.

The **1** and **B** indicators will light up constantly.



- Confirm the setting with the run-on option control ⁵¹⁵.

All the indicator lights will go out.

If you do not confirm your choice of setting within 4 minutes, the cooker hood will revert to the old setting.

Safety switch-off



If Power management has been deactivated, the cooker hood will switch itself off automatically after 12 hours if it has been left on (fan and hob lighting).

- To switch it on again press the On/Off  control or the lighting control .

Operation (Automatic and Manual modes)

Operating hours counter

The cooker hood registers the length of time it has been operated.



When the grease filter symbol  or the charcoal filter symbol  lights up, the operating hours counters are signalling that the filters need to be cleaned or changed. Further information about cleaning and replacing the filters and resetting the operating hours counter can be found under “Cleaning and care”.

Altering the operating hours counter for the grease filter(s)

You can set the operating hours counter to suit the type of cooking you do.

The factory default setting is a cleaning interval of 30 hours.

- Select a shorter time of 20 hours if you fry a lot.
- If you only cook occasionally, we recommend that you still select a short time. This is to prevent grease hardening on the filter(s) and making cleaning more difficult.
- Select a longer time of 40 or 50 hours if you use very little fat for cooking.

- Switch off the fan and the lighting.
- Press the run-on  control and the operating hours control  at the same time.

The Grease filter symbol  and one of the fan power level indicators will flash.

Fan power level indicators **1** to **B** show the time set:

1	20 hours
2	30 hours
3	40 hours
B	50 hours

- Press the **—** control for a shorter duration, or **+** for a longer duration.
- Confirm your choice with the operating hours control .

All the indicator lights will go out.

If you don't confirm your selection within 4 minutes, the cooker hood will automatically revert to the original setting.

Operation (Automatic and Manual modes)



Altering or deactivating the charcoal filter operating hours counter

Charcoal filters are needed for recirculation mode.

You can set the operating hours counter to suit the type of cooking you do.

It has to be deactivated for extraction mode.



It is set at the factory for 180 hours of use before the filters need replacing.

- Switch off the fan and the lighting.
- Press the + control and the operating hours control   at the same time.

The charcoal filter symbol  and one of the fan power levels will flash.

Fan power level indicators **1** to **B** show the time set:

Indicator 1	120 hours
Indicator 2	180 hours
Indicator 3	240 hours
Indicator B	deactivated





- Select the duration you want with the + or – control.
- Confirm your choice with the operating hours control  .

All the indicator lights will go out.

If you do not confirm your selection within 4 minutes, the cooker hood will automatically revert to the original setting.

Reading the filter operating hours counter

You can check the percentage of time set already used before the filter needs replacing.

- Switch the fan on with the On/Off control .
- Press and hold the operating hours control  :
 - Once, to read the grease filter operating hours. The grease filter symbol  lights up.
 - Twice, to read the charcoal filter operating hours. The charcoal filter symbol  lights up.

One or more of the fan power level indicators will flash.

The number of fan power level indicators flashing shows the percentage of the operating time which has already been used up.

Indicator 1	25 %
Indicators 1 and 2	50 %
Indicators 1 to 3	75 %
Indicators 1 to B	100 %

The number of operating hours used remains in the memory, even when the cooker hood is switched off or there is a power cut.

Energy saving tips

This cooker hood operates very efficiently and economically. The following will help you to save even more energy when using it:

- Ensure that there is sufficient ventilation in the kitchen when cooking. In extraction mode, if there is insufficient air flow the cooker hood cannot operate efficiently and this causes increased operating noise levels.
- Always cook with the lowest possible setting. This produces fewer cooking vapours, so you can use a lower cooker hood power level and therefore benefit from reduced energy consumption.
- Clean or change the filters at regular intervals. Heavily soiled filters reduce performance, increase the risk of fire and are unhygienic.
- Use the Con@ctivity function. The cooker hood will switch on and off automatically at the optimum power level for the cooking you are doing, which ensures low energy consumption.
- If you are operating the cooker hood manually, please note the following:
 - Check the power level selected on the cooker hood. A low power level is usually sufficient. Only use the Booster setting when necessary.
 - When a large volume of cooking vapours are being produced, switch to a high power level in good time. This is more efficient than operating the cooker hood for longer to try to capture cooking vapours which have already been distributed throughout the kitchen.
 - Make sure that you switch the cooker hood off after use. If cooking vapours and odours still need to be removed from the kitchen air after cooking, use the run-on function. The fan will switch off automatically after the selected run-on time.

 Before proceeding with any maintenance or cleaning task, the cooker hood must be disconnected from the power supply (see “Warning and Safety instructions”).

Housing

General information

Unsuitable cleaning agents can damage the surfaces and control elements.

Do not use any cleaning agents containing soda, acid, chloride or solvent.

Do not use any abrasive cleaning agents, e.g. powder cleaners or cream cleaners and abrasive sponges, as well as pot scourers or sponges which have been used previously with abrasive cleaning agents.

 Moisture in the cooker hood can cause damage.
Make sure that water does not get into the cooker hood.

- All external surfaces and control elements can be cleaned using hot water with a small amount of washing-up liquid applied with a well wrung-out soft sponge or cloth.
- After cleaning, wipe the surfaces dry using a soft cloth.

Important information for appliances with stainless steel surfaces

This information does not apply to the control buttons.

Stainless steel surfaces can be cleaned with a non-abrasive cleaning agent designed specifically for use on stainless steel.

To prevent the surfaces from quickly becoming dirty again, we recommend treating them with a stainless steel care product (available from Miele).

Important information for the control elements

If soiling is not removed promptly, it could cause the control elements to alter or discolour.

Remove any soiling immediately.

The surface of the control elements can become damaged if they are cleaned using stainless steel cleaning agents.

Do not use stainless steel cleaning agents on the control elements.

Cleaning and care

Grease filters and panel for edge extraction



Fire hazard

Oversaturated grease filters are a fire hazard.

Clean the grease filters at regular intervals.

The edge extraction panel and the re-usable metal grease filters in the appliance remove solid particles (grease, dust, etc.) from the kitchen vapours, preventing soiling of the cooker hood.

The grease filters and the panel must be cleaned at regular intervals.

Heavily soiled grease filters hinder air extraction and will lead to increased levels of soiling in the cooker hood and in the kitchen.

Cleaning interval

The edge extraction panel should be cleaned regularly (at least every 3 - 4 weeks) to avoid a build-up of grease.

The operating hours counter will remind you to clean the edge extraction panel and the grease filters regularly via the grease filter symbol  which will light up.

You can set the operating hours counter interval to suit the type of cooking you do (see “Operation (Automatic and Manual modes)”).

Removing the panel and grease filters



The panel and grease filter can fall out when you are handling them. This can result in damage. Make sure you hold the panel and the grease filter securely at all times when handling them.

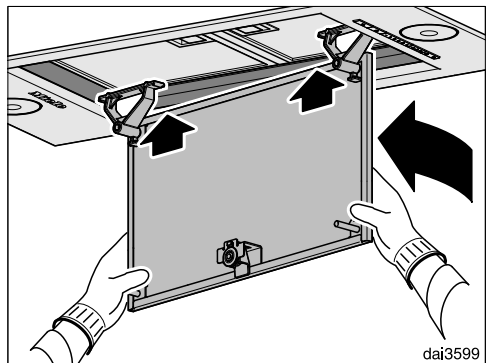
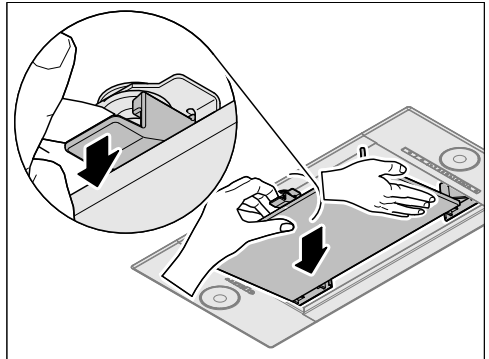

- Hold the panel with one hand and release the catch with the other hand. Lower the panel.
- Lift the panel slightly upwards, and then lift it forwards to remove it.

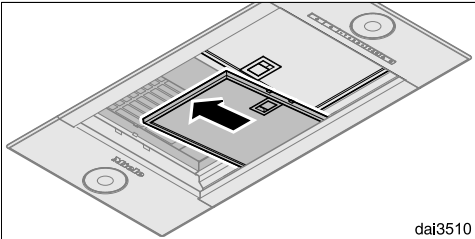
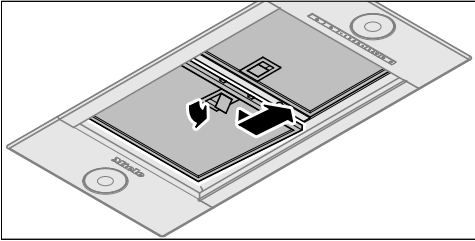

- Open the grease filter retainer catch and remove the filter.

Cleaning the panel by hand

- For cleaning purposes, follow the instructions provided under "Housing".

Cleaning the grease filters by hand

- Clean the filters with a soft nylon brush in a mild solution of hot water and a small amount of washing-up liquid. Do not use "neat" washing up liquid.

Unsuitable cleaning agents

Unsuitable cleaning agents can cause damage to the surface of the filters if used regularly.

Do not use:

- cleaning agents containing descaling agents
- powder cleaners, cream cleaners
- aggressive multi-purpose cleaning agents or spray cleaners for grease
- oven sprays

Cleaning the panel and the grease filters in the dishwasher

- Place the panel and the grease filters upright or slightly inclined in the lower basket. Ensure the spray arm is not obstructed.
- Use a commercially available household dishwasher detergent.
- Select a dishwasher programme with a wash temperature between 50 °C and 65 °C.

Depending on the detergent used, cleaning the filters in a dishwasher may cause the inside filter surfaces to become discoloured. This will not affect the functioning of the grease filters in any way.

Cleaning and care

After cleaning

- After cleaning, leave the filters to dry on an absorbent surface before replacing them.
- When removing the panel and filters for cleaning, also clean off any residues of oil or fat from the now accessible parts of the casing to prevent the risk of these catching fire.
- Replace the grease filters, making sure that the locking clips are facing down towards the hob.

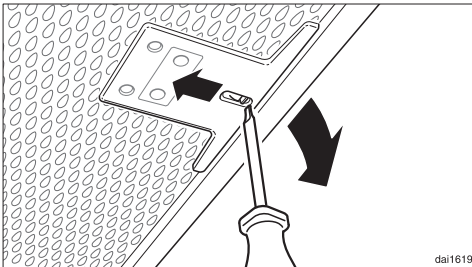

- If a grease filter is inadvertently replaced upside down, insert a small screwdriver blade into the slit to disengage the clip.

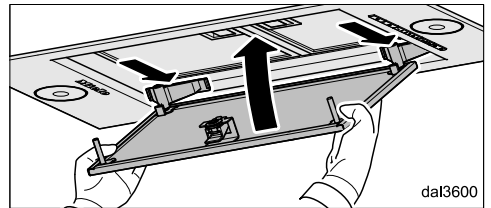
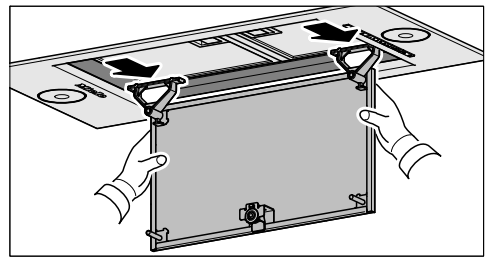
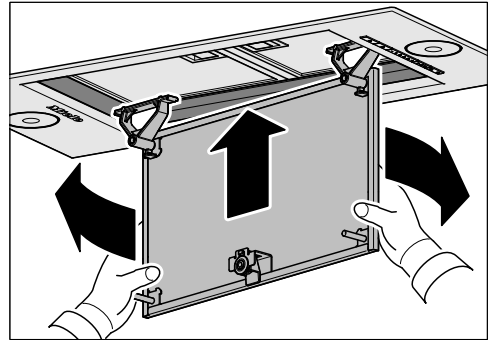



- Lift the panel into the deflector plate and hook it in at the back.
- Lift the panel upwards at the front and press it into the locking clip.

The panel can also be turned 180° and fitted. Depending on where the cooker hood is installed, this can make it easier to remove and refit the panel.

Resetting the grease filter operating hours counter

After cleaning, the operating hours counter needs to be reset.

- Whilst the fan is switched on, press the operating hours control  for approx. 3 seconds, until only **1** is flashing.

The grease filter symbol  goes out.

If you want to clean the grease filters before the operating hours counter has reached its maximum:

- Press the operating hours control  for approx. 6 seconds, until only **1** is flashing.

Charcoal filters

With recirculation mode, two charcoal filters must be fitted in addition to the grease filters. These are designed to absorb cooking odours.

The charcoal filters are fitted in the canopy above the grease filters.

Charcoal filters are available to order via the Miele Webshop, the Miele Spare Parts Department (see end of this booklet for contact details) or from your Miele dealer. The type of charcoal filter required is listed under “Technical data” at the back of this booklet.

Fitting/replacing charcoal filters

- Before fitting or replacing a charcoal filter, the panel and the grease filters must first be taken out (see previous section for instructions on how to do this).
- Take the charcoal filters out of their packaging.

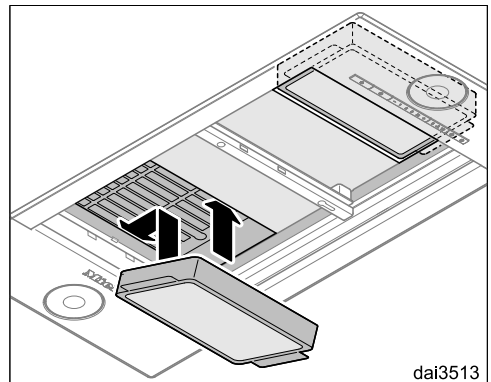

- Press the charcoal filters into the frame.
- Replace the grease filters.

Cleaning and care



When to change the charcoal filters

Replace the charcoal filters when they no longer absorb kitchen odours effectively, and at least every 6 months.

The operating hours counter will remind you to replace the charcoal filters by lighting up the charcoal filter symbol .



Resetting the charcoal filter operating hours counter

After changing the charcoal filters, the operating hours counter needs to be reset.

- To do this, with the fan switched on, press the operating hours control   twice, then hold it for approx. 3 seconds until only the **1** is flashing.

The Charcoal filter symbol  will go out.

If you want to replace the charcoal filters **before** the operating hours counter has reached its maximum:

- Press the operating hours control   twice and hold it for approx. 6 seconds until only the **1** is flashing.

Disposing of charcoal filters

- Used charcoal filters can be disposed of with normal household waste.

Before installation

 Before installation, it is important to read the information given on the following pages as well as the “Warning and Safety instructions” at the beginning of this booklet.

The cooker hood is intended for installation in a wall unit, chimney unit or above breakfast bars or island areas.

- Check prior to installation that the top of the appliance will be accessible after installation.

If this is not the case, install the exhaust ducting and prepare the mains connection **before** installation.

Installation

- ① Alternative vent connection at the back.
- ② Alternative vent connection with 222 x 89 mm flat ducting for ducting to the rear or to the side.
- ③ The cooker hood is fastened in the cut-out using clamps. A solid installation surface, e.g. made of wood, is required. Make sure that the structure can support the load. Around the clamps, components such as supports and ducting must be at least 25 mm from the cut-out.
- ④ Alternatively, the cooker hood can be secured to four fixing points on an interim shelf.
- ⑤ Additional fixing points on the installation surface.

Safety distance between hob and cooker hood (S)

When planning the installation height of your cooker hood, the minimum safety distance between the top of a cooker or hob and the bottom of the cooker hood is as follows, unless a greater distance is specified by the manufacturer of your cooking appliance.

See “Warning and Safety” instructions for further information.

Cooking appliance	Minimum distance S
Electric hob	450 mm
Electric grill, deep fat fryer (electric)	650 mm
Multi-burner gas hob, total output ≤ 12.6 kW, no burner > 4.5 kW	650 mm
Multi-burner gas hob, total output > 12.6 kW and ≤ 21.6 kW, no burner > 4.8 kW.	760 mm
Multi-burner gas hob, total output > 21.6 kW, or multi-burner gas hob where one burner > 4.8 kW.	Not possible
Single burner gas hob, output ≤ 6 kW.	650 mm
Single burner gas hob, output > 6 kW and ≤ 8.1 kW.	760 mm
Single burner gas hob, output > 8.1 kW	Not possible

Installation recommendations

- When deciding on the safety distance between the hob and cooker hood, please note that a distance of 650 mm above electric cookers/hobs may be preferable to give more working space under the hood.
- Account should also be taken of the height of the person who will be using the hood most often. They should have sufficient space to work comfortably at the hob, and be able to reach the cooker hood controls with ease.
- Please be aware that if positioned too high, extraction will be inefficient.
- To achieve optimum vapour extraction, the cooker hood must be centred over the hob, not to the side or behind it.
- The hob should be no wider than the cooker hood, and if possible, it should be narrower.
- The installation area must be easily accessible. The cooker hood should be easily accessible and easy to dismantle in the event that service is required. This should be taken into consideration when planning the position of cupboards, shelves, ceilings or features in the vicinity of the cooker hood.

Installation materials

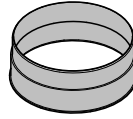

1 vent connection
for exhaust ducting \varnothing 150 mm.

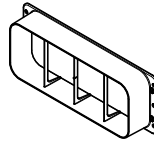

1 connector for flat ducting to the rear or the side (only for EXTA models)

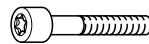

4 M5 x 40 mm screws, 4 washers, 4 M5 nuts for securing the cooker hood to an interim shelf.



10 M4 x 8 mm screws for securing the cooker hood.



4 M4 x 12 mm screws for additional securing of the cooker hood to uneven surfaces.

08055780

Stutzen Flach

07761730

00010889

8165620

08055672

07270730

Installation

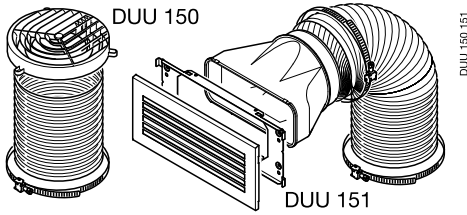

Conversion kit for recirculation mode

including directional unit, aluminium hose and hose clips (the conversion kit is not supplied and must be purchased separately. See “Technical data”).

Keep the following in a safe place:

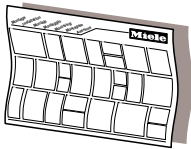

Installation plan

See the installation plan for details on the individual steps involved in the installation of this appliance.

Uneven installation surfaces

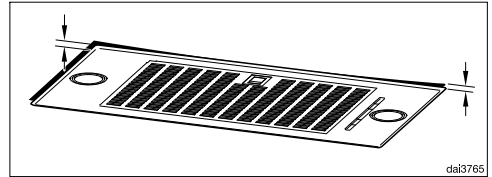

If the installation surface is uneven making flush installation difficult, the frame can be realigned.

- Fit the cooker hood as described on the installation sheet.
- Disconnect the cooker hood from the mains electrical supply before replacing the lamps (see “Warning and Safety instructions”).

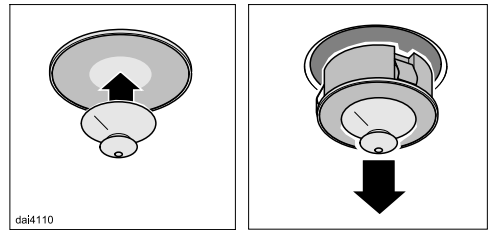

- Using the suction cup supplied, pull the lamp out of its holder.
- Remove all other lamps in the same way.

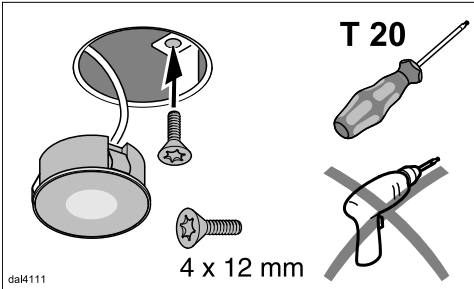

- Fit one of the screws supplied into each lamp opening.
- Tighten the screws with a screwdriver until the frame sits flush with the installation surface.

Do not overtighten the screws.

- Replace the lamps.

Connection for air extraction

⚠ If the cooker hood is used at the same time as a heating appliance that relies on oxygen from the same room, there is a risk in certain circumstances of toxic fumes building up.

It is essential that the “Warning and Safety” instructions are observed. The cooker hood should be installed according to local and national building regulations. Seek approval from the building inspector where necessary.

Only use smooth pipes or flexible exhaust ducting made from approved non-flammable materials for exhaust ducting.

Use rigid exhaust ducting for ... EXT/EXTA model cooker hoods. The external motor can cause an underpressure which can result in the exhaust ducting distorting.

To achieve the most efficient air throughput with the lowest noise levels, please note the following:

- The diameter of the exhaust ducting must not be smaller than the cross-section of the exhaust duct (see “Appliance dimensions”). This applies in particular when using flat ducting.
- The exhaust ducting should be as short and straight as possible.
- Only use wide radius bends.
- The exhaust ducting must not be kinked or compressed.

Installation

- All connections must be strong and airtight.
- If the exhaust ducting has flaps, these must be opened whenever the cooker hood is switched on.

Any constriction of the air throughput will reduce extraction performance and increase operating noise.

Flue

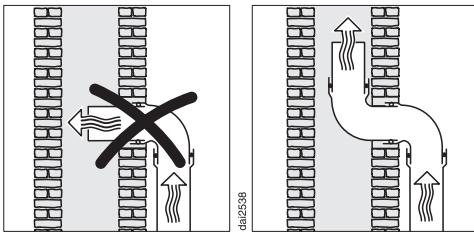

If the exhaust air is to be ducted into a flue, the ducting must be directed in the flow direction of the flue.

If the flue is used by several ventilation units, the cross-section of the flue must be large enough.

Non-return flap

- Use a non-return flap in the exhaust system.

A non-return flap ensures that when the cooker hood is not in operation, the duct is closed to prevent unwanted exchange of room air and outside air.

If the exhaust is ducted through an outside wall, a Miele wall vent or roof vent (available as an optional accessory) is recommended. Both of these have a built-in non-return flap.

If the on-site ventilation system does not have a non-return flap, you can purchase one as an optional accessory.

Condensation

If the exhaust ducting is to run through cool rooms or ceiling space, for example, the significant variations in temperature between the different areas can cause condensation to form.

Insulate the exhaust ducting to reduce temperature variations.

If the exhaust ducting is to be laid horizontally, it must be laid with a downwards sloping gradient of at least 1 cm per meter. This is to ensure that condensation cannot drain back into the cooker hood.

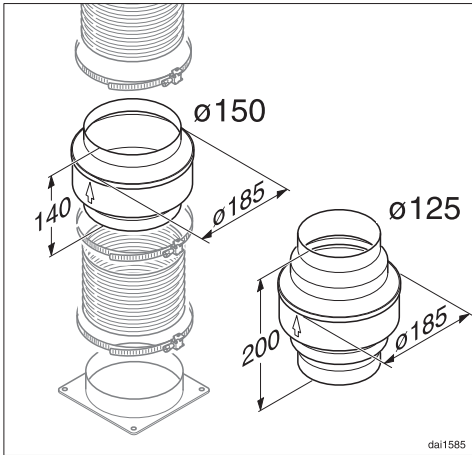

In addition to insulating the exhaust ducting, it is advisable to also install a condensate trap for collecting and evaporating any potential condensation.

Condensate traps for 125 mm or 150 mm diameter exhaust ducting are available as optional accessories.

When installing a condensate trap, ensure that it is positioned vertically and as closely as possible to the cooker hood above the exhaust connection. The arrow on the casing indicates the direction of airflow.

The condensate trap will be integrated in cooker hoods which are designed to be connected to an external motor (EXT/EXTA models).

Miele shall not accept warranty claims for any functional defects or damage caused by inadequate exhaust ducting.

Silencer

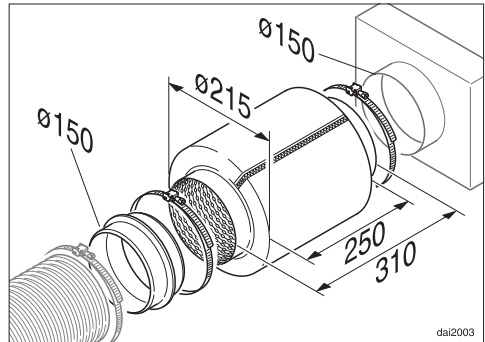

To reduce noise levels even further, a silencer (optional accessory) can be installed in the exhaust ducting.

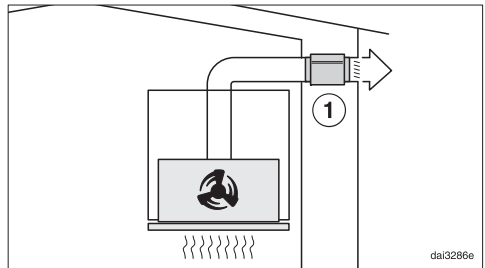

In extraction mode, the silencer not only reduces noise from the fan outside the house, but also sounds originating outside reaching the kitchen through the exhaust ducting (e.g. traffic noise). For this reason, the silencer must be positioned as close as possible to the ducting exit ①.

Installation

In recirculation mode, the silencer needs to be positioned between the exhaust vent and the exhaust grille ②. Check that there is sufficient space.

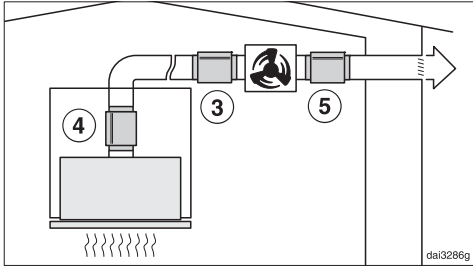

For operation with an external motor, noise from the motor outside the house and inside the kitchen can be minimised.

Positioning the silencer in front of the external motor ③ reduces noise inside the kitchen. If the exhaust ducting is long, the silencer needs to be positioned at the exhaust duct in the ducting above the cooker hood itself ④. For an external motor installed inside the house, noise from the motor outside the house can be reduced by positioning the silencer behind the external motor ⑤.

Electrical connection

Refer to the notes in “Electrical connection” and “Warnings and safety notes” before connecting to the power supply.

The connection data (voltage, frequency) on the data plate must match the data of the mains power supply. The position of the data plate is explained in the “Service” chapter.

The cooker hood is equipped with a power cable and a safety plug.

The connection must be made via a socket which remains accessible after the cooker hood has been installed. If the socket is no longer accessible after installation or if you are using a hard-wired connection, there must be a suitable means of disconnection for all poles in the household electrical system which meets the requirements of overvoltage category III.

Safety can be increased by fitting the appliance with a residual current device.

Only qualified electricians are permitted to carry out work on the household electrical system.

This appliance must be earthed.

Contact in the event of a fault

In the event of any faults which you cannot remedy yourself, please contact your Miele dealer or the Miele Customer Service Department.

You can book a Miele Customer Service Department call-out online at www.miele.com/service.

Contact information for the Miele Customer Service Department can be found at the end of this document.

Please quote the model identifier and serial number of your appliance (Fabr./SN/Nr.) when contacting the Miele Customer Service Department. This information can be found on the data plate.

Please note that telephone calls may be monitored and recorded for training purposes and that a call-out charge will be applied to service visits where the problem could have been resolved as described in this booklet.

Position of the data plate

The data plate is visible after removing the grease filters.

Warranty

For information on the appliance warranty specific to your country please contact Miele. See back cover for address.

In the UK, your appliance warranty is valid for 2 years from the date of purchase. However, you must activate your cover by calling 0330 160 6640 or registering online at www.miele.co.uk.

Technical data

Fan motor*	80 W
Hob lighting	
DA 2668	2 x 4.5 W
DA 2698	4 x 3 W
DA 2628	3 x 4.5 W
Total rated load*	
DA 2668	89 W
DA 2698	92 W
DA 2628	93.5 W
Mains voltage, frequency	AC 230 V, 50 Hz
Fuse rating	3 A
Mains connection cable length	1.5 m
Weight	
DA 2668	12 kg
DA 2698	14 kg
DA 2628	15 kg
DA 2698 EXTA	11 kg

* For EXTA models, the rated load and extraction power will depend on the type of external motor fitted.

Length of connection cable to external motor: 1.9 m

WiFi module

Frequency band	2.400–2.4835 GHz
Maximum transmission power	< 100 mW

Special accessories for recirculation mode

DUU 150 or DUU 151 conversion kit and DKF 19-P charcoal filter set. The set contains two active charcoal filters.

Conformity declaration

Miele hereby declares that this cooker hood complies with Directive 2014/53/EU.

The complete text of the EU declaration of conformity is available from one of the following internet addresses:

- Products, Download from www.miele.co.uk
- For service, information, operating instructions etc: go to www.miele.co.uk/domestic/customer-information-385.htm and enter the name of the product or the serial number

Note for test institutes

Energy efficiency must be calculated using extraction mode. The cooker hood is set up ex-works for recirculation mode. To re-set it for extraction mode the operating hours counter for the charcoal filter(s) has to be deactivated (see “Before using for the first time”).

Technical data

Data sheet for household cooker hoods

In acc. with delegated regulation (EU) No. 65/2014 and regulation (EU) No. 66/2014

MIELE	
Model name/identifier	DA 2668
Annual Energy Consumption (AEC _{hood})	28,4 kWh/year
Energy efficiency class	A+
Energy efficiency index (EEI _{hood})	42,3
Fluid Dynamic Efficiency (FDE _{hood})	36,0
Fluid Dynamic Efficiency class	
A (most efficient) to G (least efficient)	A
Lighting Efficiency (LE _{hood})	77,8 lx/W
Lighting Efficiency class	
A (most efficient) to G (least efficient)	A
Grease Filtering Efficiency	95,8%
Grease Filtering Efficiency class	
A (most efficient) to G (least efficient)	A
Airflow at best efficiency point	310,9 m ³ /h
Air flow (min. speed)	175 m ³ /h
Air flow (max. speed)	365 m ³ /h
Air flow (intensive or boost setting)	585 m ³ /h
Max. air flow (Q _{max})	585 m ³ /h
Air pressure at best efficiency point	355 Pa
Airborne acoustical A-weighted sound power emissions (min. speed)	35 dB
Airborne acoustical A-weighted sound power emissions (max. speed)	51 dB
Airborne acoustical A-weighted sound power emissions (intensive or boost setting)	64 dB
Electrical power input at best efficiency point	85,0 W
Power consumption in off mode (P _o)	W
Power consumption in standby mode (P _s)	0,35 W
Nominal power of lighting system	9,0 W
Average illumination of the lighting system on the cooking surface	700 lx
Time increase factor	0,7

Data sheet for household cooker hoods

In acc. with delegated regulation (EU) No. 65/2014 and regulation (EU) No. 66/2014

MIELE	
Model name/identifier	DA 2698
Annual Energy Consumption (AEC_{hood})	28,6 kWh/year
Energy efficiency class	A+
Energy efficiency index (EEL_{hood})	37,7
Fluid Dynamic Efficiency (FDE_{hood})	40,1
Fluid Dynamic Efficiency class	
A (most efficient) to G (least efficient)	A
Lighting Efficiency (LE_{hood})	54,2 lx/W
Lighting Efficiency class	
A (most efficient) to G (least efficient)	A
Grease Filtering Efficiency	95,3%
Grease Filtering Efficiency class	
A (most efficient) to G (least efficient)	A
Airflow at best efficiency point	386,2 m ³ /h
Air flow (min. speed)	200 m ³ /h
Air flow (max. speed)	400 m ³ /h
Air flow (intensive or boost setting)	640 m ³ /h
Max. air flow (Q_{max})	640 m ³ /h
Air pressure at best efficiency point	367 Pa
Airborne acoustical A-weighted sound power emissions (min. speed)	36 dB
Airborne acoustical A-weighted sound power emissions (max. speed)	51 dB
Airborne acoustical A-weighted sound power emissions (intensive or boost setting)	62 dB
Electrical power input at best efficiency point	98,0 W
Power consumption in off mode (P_o)	W
Power consumption in standby mode (P_s)	0,35 W
Nominal power of lighting system	12,0 W
Average illumination of the lighting system on the cooking surface	650 lx
Time increase factor	0,6

Technical data

Data sheet for household cooker hoods

In acc. with delegated regulation (EU) No. 65/2014 and regulation (EU) No. 66/2014

MIELE	
Model name/identifier	DA 2628
Annual Energy Consumption (AEC_{hood})	26,8 kWh/year
Energy efficiency class	A+
Energy efficiency index (EEl_{hood})	37,7
Fluid Dynamic Efficiency (FDE_{hood})	40,9
Fluid Dynamic Efficiency class	
A (most efficient) to G (least efficient)	A
Lighting Efficiency (LE_{hood})	51,9 lx/W
Lighting Efficiency class	
A (most efficient) to G (least efficient)	A
Grease Filtering Efficiency	95,2%
Grease Filtering Efficiency class	
A (most efficient) to G (least efficient)	A
Airflow at best efficiency point	340,4 m ³ /h
Air flow (min. speed)	200 m ³ /h
Air flow (max. speed)	400 m ³ /h
Air flow (intensive or boost setting)	640 m ³ /h
Max. air flow (Q_{max})	640 m ³ /h
Air pressure at best efficiency point	380 Pa
Airborne acoustical A-weighted sound power emissions (min. speed)	36 dB
Airborne acoustical A-weighted sound power emissions (max. speed)	51 dB
Airborne acoustical A-weighted sound power emissions (intensive or boost setting)	62 dB
Electrical power input at best efficiency point	88,0 W
Power consumption in off mode (P_o)	W
Power consumption in standby mode (P_s)	0,35 W
Nominal power of lighting system	13,5 W
Average illumination of the lighting system on the cooking surface	700 lx
Time increase factor	0,5

Data sheet for household cooker hoods

In acc. with delegated regulation (EU) No. 65/2014 and regulation (EU) No. 66/2014

MIELE	
Model name/identifier	DA 2698 EXTA
Annual Energy Consumption (AEC _{hood})	112,6 kWh/year
Energy efficiency class	C
Energy efficiency index (EEI _{hood})	78,0
Fluid Dynamic Efficiency (FDE _{hood})	20,1
Fluid Dynamic Efficiency class	
A (most efficient) to G (least efficient)	C
Lighting Efficiency (LE _{hood})	54,2 lx/W
Lighting Efficiency class	
A (most efficient) to G (least efficient)	A
Grease Filtering Efficiency	95,3%
Grease Filtering Efficiency class	
A (most efficient) to G (least efficient)	A
Airflow at best efficiency point	431,8 m ³ /h
Air flow (min. speed)	325 m ³ /h
Air flow (max. speed)	590 m ³ /h
Air flow (intensive or boost setting)	735 m ³ /h
Max. air flow (Q _{max})	735 m ³ /h
Air pressure at best efficiency point	376 Pa
Airborne acoustical A-weighted sound power emissions (min. speed)	47 dB
Airborne acoustical A-weighted sound power emissions (max. speed)	61 dB
Airborne acoustical A-weighted sound power emissions (intensive or boost setting)	67 dB
Electrical power input at best efficiency point	222,6 W
Power consumption in off mode (P _o)	W
Power consumption in standby mode (P _s)	0,35 W
Nominal power of lighting system	12,0 W
Average illumination of the lighting system on the cooking surface	650 lx
Time increase factor	1,3

The above values were determined in combination with the Miele ABLG 202 external motor.

United Kingdom

Miele Co. Ltd., Fairacres, Marcham Road, Abingdon, Oxon, OX14 1TW

Tel: 0330 160 6600, Internet: www.miele.co.uk/service, E-mail: info@miele.co.uk

Australia

Miele Australia Pty. Ltd.

ACN 005 635 398

ABN 96 005 635 398

1 Gilbert Park Drive

Knoxfield, VIC 3180

Tel: 1300 464 353

Internet: www.miele.com.au

China Mainland

Miele Electrical Appliances Co., Ltd.

1-3 Floor, No. 82 Shi Men Yi Road
Jing' an District

200040 Shanghai, PRC

Tel: +86 21 6157 3500

Fax: +86 21 6157 3511

E-mail: info@miele.cn,

Internet: www.miele.cn

Hong Kong, China

Miele (Hong Kong) Ltd.

41/F - 4101, Manhattan Place

23 Wang Tai Road

Kowloon Bay, Hong Kong

Tel: (852) 2610 1025

Fax: (852) 3579 1404

Email:

customerservices@miele.com.hk

Website: www.miele.hk

India

Miele India Pvt. Ltd.

1st Floor, Copia Corporate Suites,
Commercial Plot 9,

Mathura Road, Jasola,

New Delhi - 110025

E-mail: customercare@miele.in

Website: www.miele.in

Ireland

Miele Ireland Ltd.

2024 Bianconi Avenue

Citywest Business Campus

Dublin 24

Tel: (01) 461 07 10

Fax: (01) 461 07 97

E-Mail: info@miele.ie

Internet: www.miele.ie

Malaysia

Miele Sdn Bhd

Suite 12-2, Level 12

Menara Sapura Kencana

Petroleum

Solaris Dutamas No. 1

Jalan Dutamas 1

50480 Kuala Lumpur, Malaysia

Phone: +603-6209-0288

Fax: +603-6205-3768

New Zealand

Miele New Zealand Limited

IRD 98 463 631

8 College Hill

Freemans Bay, Auckland 1011

New Zealand

Tel: 0800 464 353

Internet: www.miele.co.nz

Singapore

Miele Pte. Ltd.

29 Media Circle

#11-04 ALICE@Mediapolis

Singapore 138565

sTel: +65 6735 1191

Fax: +65 6735 1161

E-Mail: info@miele.com.sg

Internet: www.miele.sg

South Africa

Miele (Pty) Ltd.

63 Peter Place

Bryanston 2194

P.O. Box 69434

Bryanston 2021

Tel: (011) 875 9000

Fax: (011) 875 9035

E-mail: info@miele.co.za

Internet: www.miele.co.za

Thailand

Miele Appliances Ltd.

BHIRAJ TOWER at EmQuartier

43rd Floor Unit 4301-4303

689 Sukhumvit Road

North Klongton Sub-District

Vadhana District

Bangkok 10110, Thailand

United Arab Emirates

Miele Appliances Ltd.

Showroom 1

Eiffel 1 Building

Sheikh Zayed Road, Umm Al Sheif

P.O. Box 114782 - Dubai

Tel. +971 4 3044 999

Fax. +971 4 3418 852

800-MIELE (64353)

E-Mail: info@miele.ae

Website: www.miele.ae

Manufacturer: Miele & Cie. KG, Carl-Miele-Straße 29, 33332 Gütersloh, Germany

DA 2668, DA 2698, DA 2628, DA 2698 EXTA

en-GB

M.-Nr. 11 742 670 / 01