

PT650D

WEIGHING INDICATOR

INSTRUCTION MANUAL

www.toannanggroup.com.vn

VER 2002

CONTENTS

1. DESCRPTION.....	1
1-1 Introduction.....	1
1-2 Definition.....	1
1-3 Features.....	2
2. SPECIFICATON.....	3
2-1 General.....	3
2-2 Digital section.....	3
2-3 Analog section.....	3
2-4 RS232/RS485 output (option).....	4
2-5 Hi/LO setpoint output (option).....	6
2-6 BCD output interface(option).....	6
2-7 Analog output interface(option).....	6
2-8 Input interface	6
3. OPERATION.....	7
3-1 General rules.....	7
3-2 Input sensitivity of load cell.....	7
3-3 Connecting the load cell to the indicator.....	8
4. DISPLAYS AND KEYS.....	9
4-1 Display.....	9
4-2 Front panel description.....	9
4-3 Rear panel description.....	10
5. FUNCTION SETTING.....	11
5-1 Data setting.....	11
5-2 Function setting by using RS232/RS485.....	17

6. CALIBRATION.....	21
6-1 During span setting.....	21
6-2 Setting steps.....	21
6-3 Error code during calibration.....	25
6-4 Calibration by using RS232/RS485.....	26
7. DISPLAYED AND OUTPUT VALUES.....	29
8. SETTING THE SETPOINT.....	30
8-1 Setting steps.....	30
8-2 Setting setpoint by using RS232/RS485.....	35
9. OUTPUT/INPUT.....	37
9-1 Comparator output (option).....	37
9-2 Input.....	40
9-3 RS232/RS485 output (option).....	41
9-4 BCD data output interface (option).....	45
9-5 Analog output interface (option).....	47
10. DIMENSION.....	49
11. APPENDIX.....	50
11-1 Single material batching control software (option).....	50
11-2 PT650D 110V and 220V setting.....	57
11-3 Standard ASCII code table.....	58
11-4 PT650D function list.....	59

Note: All product improvement is authorized by **Chi Mei Electronics Co., Ltd.** , so no prior notice for technical improvement.

www.toannanggroup.com.vn

1. DESCRIPTION

1-1 INTRODUCTION

PT650D is a kind of general weighing indicator, employing the latest technology for the reliable and best performance quality assurance, cost effective design which includes many functions. PT650D is suitable for all kinds of application such as hopper and weigh platform.

1-2 DEFINITION

Multiplier:

The multiplier determine the position of the decimal point or the number of tailing zero added to the internal reading.

For example:

If the internal reading is 234,

<u>Multiplier</u>	<u>Display on indicator</u>
10	2340
1	234
.1	23.4
.01	2.34
.001	.234
.0001	.0234

Division:

The ratio of step width to multiplier. The value of division can only be one of the followings: 1, 2, 5.

Step width:

The difference between two consecutive reading of the scale.

Excitation voltage:

The voltage that supplied by the indicator to the load cell.

Load cell:

Load cell is a device that converts force to electronic voltage. A load cell consists of two parts. The first part is a sensor that can be linear distorted according to the force applied to it. The second part is the strain gauge element which changes its resistance according to the distortion of the sensor.

Load cell rated output:

The output voltage from the load cell divided by the excitation voltage.

Maximum capacity:

The maximum figure ignoring decimal point that designed to be used by the indicator.

Resolution:

The ratio of the maximum capacity and division.

Dead weight:

The output voltage of the load cell in response to the weight of the platform.

Span:

The change of reading from the indicator in response to the change of standard weight applied.

1-3 FEATURES

- Apply for all strain gauge load cell;
- Clear and stable 13mm 6 digitals LED display;
- gross weight and net weight can be selected;
- Display step width is selectable of 1, 2, 5, 10, 20 or 50;
- Numeric display "O.L." when overload;
- Display decimal point is selectable of 4 decimal places;
- Automatic zero tracking;
- Automatically set tare by push button;
- Delta-sigma conversion method;
- Internal resolution is 16,000,000 counts;
- Scale display resolution from 300 to 10,000;
- Conversion rate up to 200 times/sec;
- Software function setting method;
- External on/off switch for function and calibration setting protection;
- Option:
 - RS232/RS485 input and output port;
 - Hi/Lo comparator output (opto-couple, dielectric strength 80VDC, 300mA);
 - Parallel BCD output;
 - or Analog output;
- Optional software: single material batching control software.

2. SPECIFICATION

2-1 GENERAL

- | | |
|--------------------------|-------------------------------------|
| 1. Mains supply | : 110VAC, 220VAC \pm 10%, 50/60Hz |
| 2. Power consumption | : 9 VA |
| 3. Operating temperature | : -5°C to 50°C (23°F to 122°F) |
| 4. Relative Humidity | : 90%(non-condensing) |
| 5. Weight | : Approx 0.45 kg |

2-2 DIGITAL SECTION

- | | |
|-----------------------------|---|
| 1. Weight display | : 6 digits LED display |
| 2. Display height | : 13mm |
| 3. Annunciators | : Gross, Net, Zero, Motion and unit(kg/t) |
| 4. Negative sign indication | : “-” on the left most digit |
| 5. Over-range indication | : Display “O.L” |
| 6. Maximum capacity | : 500 to 100,000 |
| 7. Step width | : 1, 2, 5, 10, 20 or 50 |
| 8. Decimal point | : Displays to four different decimal places |

2-3 ANALOG SECTION

- | | |
|--------------------------------|---|
| 1. Load cell type | : All strain gauge load cell |
| 2. Load cell supply | : 10VDC \pm 5%, 150mA |
| 3. Output sensitivity | : 0.5 μ V/D to 200 μ V/D |
| 4. Input resistance | : More than 100M Ω at 500VDC between each terminal |
| 5. Zero point adjustment | : 0.05mV to 15mV |
| 6. Span stability | : \pm ppm/ K of F.S |
| 7. Zero stability | : \pm 0.4 μ V \pm 0.006% initial zero offset voltage)/K |
| 8. Non-linearity | : Within 0.005% of F.S |
| 9. Conversion method | : Delta-sigma |
| 10. Conversion rate | : Up to 200 times/sec |
| 11. Internal resolution | : 16,000,000 |
| 12. Maximum display resolution | : 10,000 divisions |
| 13. Comparison cycle | : Approx 200 times/sec |

14. Dielectric strength : Between input terminal(common/earth/each opto-coupler output/analog output/BCD output), for 1 min, at 500VDC.
Between power supply terminal and input terminal(common/earth/each opto-coupler output/analog output/BCD output), for 1 min, at 1500VAC.

OPTION:

15. Analog or BCD output : 0~5V, 0~20mA/4~20mA(selectable), parallel BCD
16. Serial output : RS232 or RS485 option
17. Control output : Four opto-coupler option

2-4 RS232/RS485 SERIAL OUTPUT (OPTION)

- 1) STANDARD : EIA-RS232/RS485 output

- 2) STREAM FROMAT

Data bit = 7
Parity bit = 1 (even)
Stop bit = 1
Code = ASCII code
Baud rate = 2400, 4800, 9600, 19200
Delimiter = CR/LF

- 3) RS232/RS485 MODE

- a) Command mode: After receiving the command word from RS232/RS485 port, the indicator will carry out the appropriate action, those command valid only for RS232/RS485 port

Command: READ<CR><LF> : request measured data
TARE<CR><LF> : request TARE weight setting
KEY<CR><LF> : key protection ON or OFF
ZERO<CR><LF> : request ZERO value

Example: Read command (READ<CR><LF>) is "52H, 45H, 41H, 44H, 0DH, 0AH" in ASCII code.

- b) Continuous mode: The data will be transferred constantly without any input command to the RS232/RS485 port.

4) DATA FORMAT:

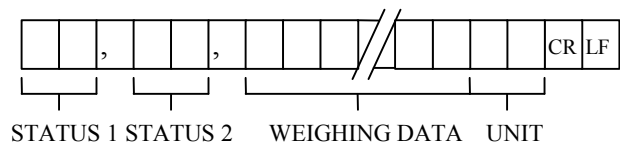

STATUS 1:

- OL = overload
- ST = stable
- US = unstable

STATUS 2:

- NT = net weight
- GS = gross weight

WEIGHING DATA:

An eight bits stream consists of "0" to "9", negative sign "-", positive sign "+", space " " and decimal point.

UNIT:

- kg = kilogram
- t = ton

5) SCHEMATIC DIGRAM FOR THE OUTPUT PORT

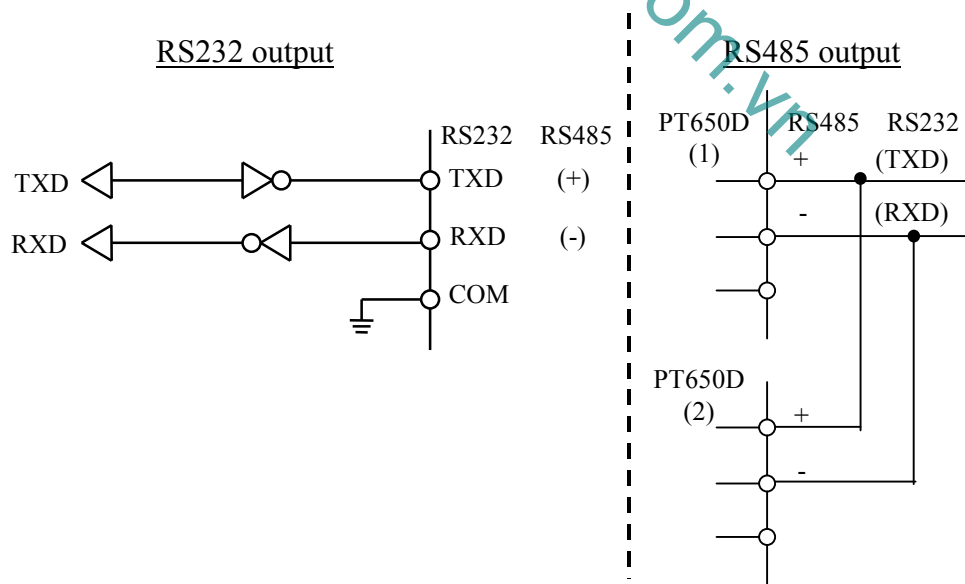

6) RS485 COMMUNICATION

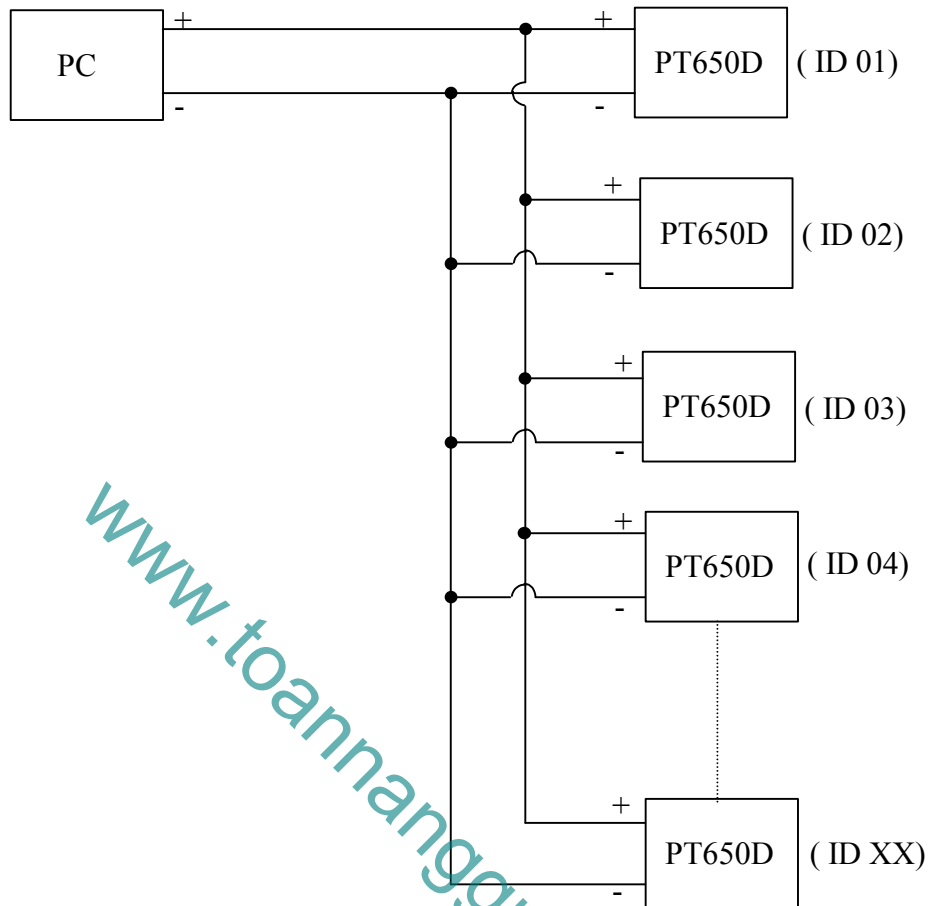

Note: ID = XX, ST62(TERMINATER) on the mainboard should be set to “ON”, a 200Ω impedance matching resistor is virtually added to communication terminal.

2-5 Hi/Lo COMPARATOR OUTPUT(OPTION)

- 1) Hi/Lo output : HH, Hi, Lo or LL
- 2) Max. capacity : 80VDC, 300mA

2-6 BCD OUTPUT(OPTION)

- 1) BCD output : Parallel BCD output
- 2) BCD output level : TTL or open collector

2-7 ANALOG OUTPUT(OPTION)

- 1) Analog output mode : 0~5V/0~20mA/4~20mA
- 2) The excitation current will be reduced to 120mA if the 0~20mA/4~20mA output board is used.

2-8 INPUT(BUILT-IN)

- 1) Input : IN1, IN2 or IN3
- 2) Input mode : Passive switch
- 3) Input contact time : 30 ms

3. OPERATION

3-1 GENERAL RULES

Do not install the PT650D in direct sunshine, and avoid sudden temperature changes, vibration or wind.

Best performance is achieved when temperature is about 20°C or 68°F and the relative humidity is about 50%.

Ground the PT650D via the power cable to the rear terminal and ensure a good ground connection. Do not ground directly to other equipment.

Analog input/output signals are sensitive to electrical noise. Do not bind these cables together as it could result in cross-talk interference. Please also keep them well away from AC power cable, and keep all cable as short as possible.

If the local AC electrical supply fluctuates by more than $\pm 10\%$ an AC regulator must be used in order to stabilize the power and reduce power spikes.

3-2 INPUT SENSITIVITY OF LOAD CELL

The input sensitivity (A) of load cell can be calculated from the following formula:

$$A = (\text{Load cell output voltage at scale capacity} - \text{load cell output voltage at dead load}) \times \text{Step width} / \text{Scale capacity}$$

PT650D requires that "A" must be greater than or equal to $0.5 \mu\text{V/D}$.

3-3 CONNECTING THE LOAD CELL TO THE INDICATOR

The analog output from the Load cell and the RS232/RS485 input/output signals are sensitive to electrical noise. Do not bind these cables together as it could result in cross-talk interference. Please also keep them well away from the AC power cables.

Load cell connections	
Pin no.	Signal
EXC+	Excitation+
EXC-	Excitation -
SIG+	Signal +
SIG-	Signal -
SHD	Shield

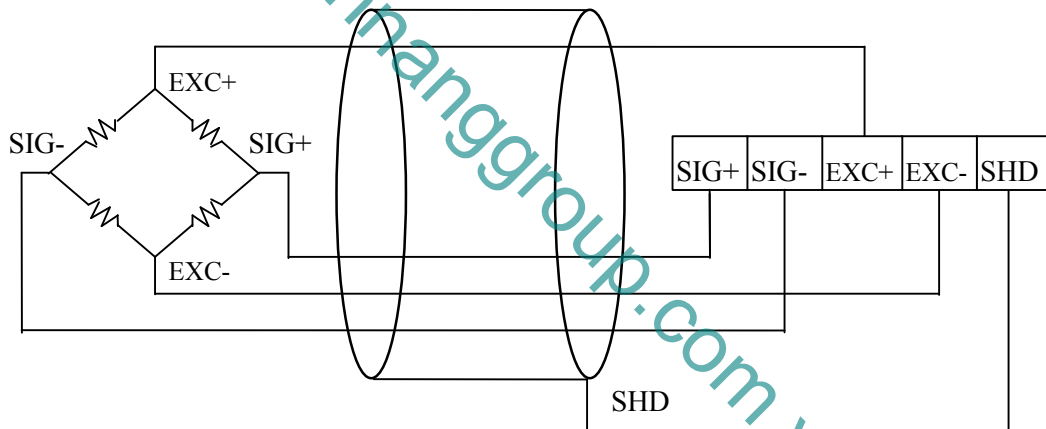

4. INDICATOR AND KEYS

4-1 INDICATOR



- Function mode : Display “FUNC” by pressing **MODE** and **G/N** keys for 2 seconds to enter the function mode
- Calibration mode : Display “CAL” by pressing **MODE** and **TARE** keys for 2 seconds to enter the calibration mode
- Hi/Lo setpoint mode: Display “SET” by pressing **MODE** and **ZERO** keys for 2 seconds to enter the Hi/Lo setpoint mode
- Indicator On/Off : Press **MODE** key for 3 seconds
- kg/lb conversion : Press **G/N** key for 2 seconds, unit is lb while “kg” annunciator is flashing, and press **G/N** key for 2 seconds, unit is kg
(Note: 1kg = 2.2046 lb)

Note: For the setting modes, press and hold **MODE** key first, otherwise, no entry is accepted. When changing the entry before its completion, press **MODE** key to input again.

4-2 FRONT PANEL DESCRIPTION

1. **MODE** key: Entry the data or skips the span at calibration.
2. **G/N** key: Selects set data items or changes the gross/net value display or skips the zero at calibration.
3. **TARE** key: Shifts the setting digit at the time of data setting or change the display mode to net mode.
4. **ZERO** key: Select the setting digit at the time of data setting or if the zero offset is within 1% to 10% of maximum capacity, press this key to return to zero.
5. **GROSS** annunciator: Indicates gross weight is displayed
6. **NET** annunciator: Indicates net weight is displayed
7. **MOTION** annunciator: Indicates motion detection
8. **ZERO** annunciator: Indicates gross value is “0”
9. **kg** annunciator: Indicates unit is “kg”
10. **t** annunciator: Indicates unit is “ton”

Note: The decimal point in the setting digit will be blink at the time of data setting. The data entry can not be a negative value.

4-3 REAR PANEL DESCRIPTION

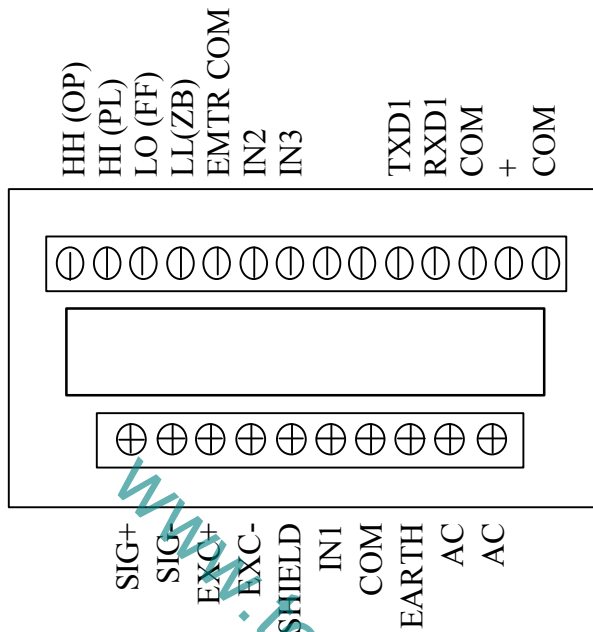

1. Mains power input terminal: AC, AC, EARTH
2. Load cell input terminal: SIG+, SIG-, EXC+, EXC-, SHIELD
3. Input terminal: IN1, IN2, IN3, COM
4. Hi/Lo comparison output terminal: HH, HI, LO, LL, EMTR COM
Single material batch output terminal: OP, PL, FF, ZB, EMTR COM
5. Serial communicate terminal: TXD1, RXD1, COM
6. Analog signal output terminal: +, COM

5. FUNCTION SETTING

Enter function setting: Press and hold **MODE** key, then press **G/N** key, 2 seconds later, displays “FUNC”, the function setting mode is selected, and set the data within “F0 0” to “F19 XX”.

If the data is changed, enter the calibration mode.

Keys description:

ZERO key : Select the function No. (from F0 to F19 to F0).

TARE key : Change the data value(from FX 0 to 1,2.....).

- Note:
- (1) Data setting by RS232/RS485 is possible.
 - (2) If an error occurs, “ERROR X” will output from RS232/RS485.
 - (3) When a “check sum” error occurs or there is the function change of “max.cap”, “mult” or “step”, PT650D is set to the “CAL” re-set mode(the message is automatically displayed). However, if the power supply is turn on/off under that state, it will enter the weighing mode.
 - (4) Percentage of zero range can be ignored.

5-1 DATA SETTING

Enter the data setting:

Press and hold **MODE** key, then press **G/N** key, 2 seconds later, displays “FUNC”.

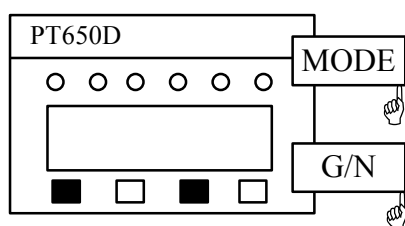

2 seconds later

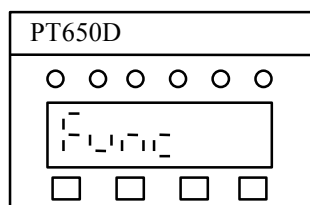

2 seconds later

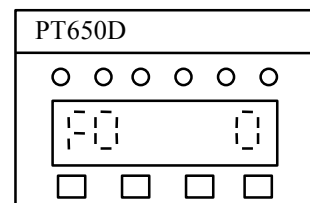

5-1-1 "F0 0" EXIT THE FUNCTION SETTING MODE

Press **MODE** key, accept the data, and enter the weighing mode, if press **ZERO** key, skip to the next setting.

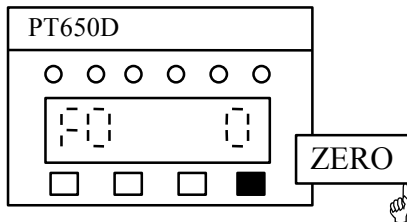

5-1-2 "F1 0" ZERO TRACK TIME

Press **TARE** key to select

0 = No track
1 = 1 sec

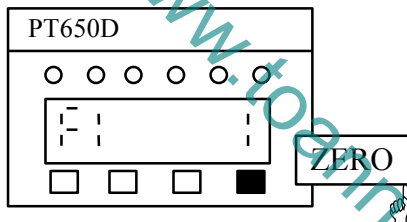

5-1-3 "F2 0" ZERO TRACK BAND

Press **TARE** key to select

0 = 1 step width
1 = 2 step width
2 = 4 step width

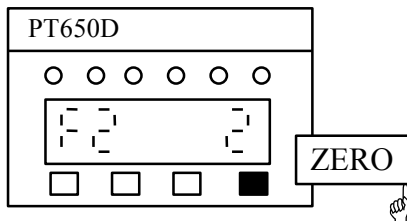

5-1-4 "F3 0" MOTION DETECTION

Press **TARE** key to select

0 = 1 step width/sec
1 = 3 step width/sec
2 = 5 step width/sec
3 = 10 step width/sec

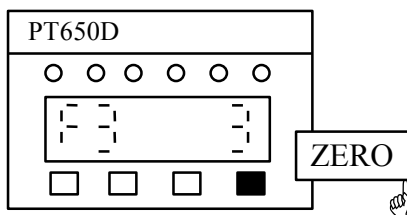

5-1-5 "F4 0" MULTIPLIER OR DECIMAL POINT

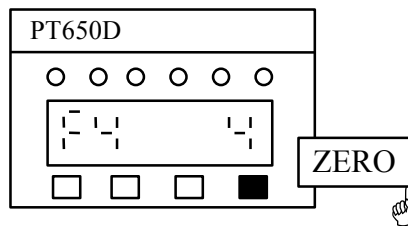
Press **TARE** key to select

- 0 = 10
- 1 = 1
- 2 = 0.1
- 3 = 0.01
- 4 = 0.001
- 5 = 0.0001

5-1-6 "F5 0" DIVISION

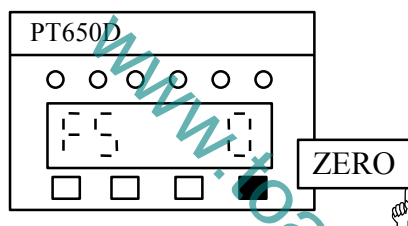
Press **TARE** key to select

- 0 = 1
- 1 = 2
- 2 = 5

5-1-7 "F6 0" MAXIMUM CAPACITY

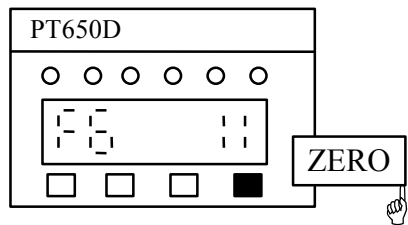
Press **TARE** key to select

- | | | |
|----------|------------|-------------|
| 0 = 500 | 8 = 5000 | 16 = 30000 |
| 1 = 1000 | 9 = 6000 | 17 = 40000 |
| 2 = 1200 | 10 = 8000 | 18 = 50000 |
| 3 = 1500 | 11 = 10000 | 19 = 60000 |
| 4 = 2000 | 12 = 12000 | 20 = 80000 |
| 5 = 2500 | 13 = 15000 | 21 = 100000 |
| 6 = 3000 | 14 = 20000 | |
| 7 = 4000 | 15 = 25000 | |

If the maximum capacity does not satisfy the following condition, it will show "ERROR 1" for 2 seconds, return to the F4 (decimal point) setting mode.

$$\text{Maximum capacity} \geq 500$$

$$\text{Maximum capacity} \leq 100,000$$

Note: "ERROR 1" is also output to RS232/RS485.

5-1-8 "F7 0" BAUD RATE

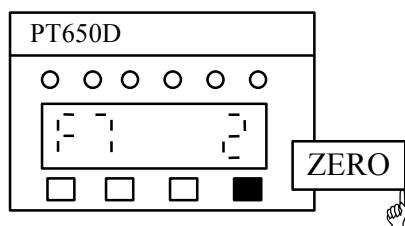
Press **TARE** key to select

- 0 = 2400 baud
- 1 = 4800 baud
- 2 = 9600 baud
- 3 = 19200 baud

5-1-9 "F8 0" RS232/RS485 OUTPUT MODE

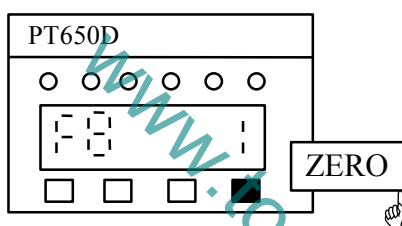
Press **TARE** key to select

- 0 = Continuous mode
- 1 = Command mode

5-1-10 "F9 0" UNIT

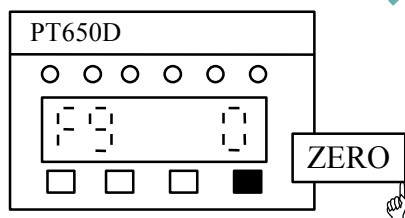
Press **TARE** key to select

- 0 = kg
- 1 = ton

5-1-11 "F10 0" ZERO RETURN RANGE

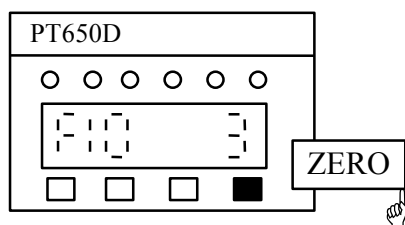
Press **TARE** key to select

- | | |
|--------|---------|
| 0 = 1% | 5 = 6% |
| 1 = 2% | 6 = 7% |
| 2 = 3% | 7 = 8% |
| 3 = 4% | 8 = 9% |
| 4 = 5% | 9 = 10% |

Note: At the normal weighing mode, the zero return range is within 1% to 10% of maximum capacity by pressing **ZERO** key.

5-1-12 "F11 0" DIGITAL FILTER

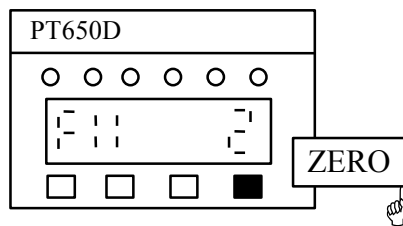
Press **TARE** key to select

0 = 0	5 = 32
1 = 2	6 = 64
2 = 4	7 = 128
3 = 8	8 = 256
4 = 16	9 = 512

0	More sensible
▲	◇
▼	▽
512	Less sensible

5-1-13 "F12 0" DISPLAY UPDATE RATE

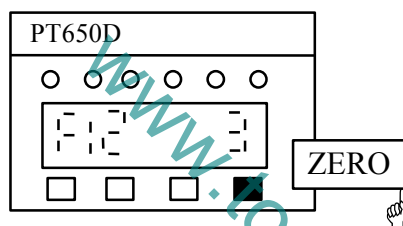
Press **TARE** key to select

0 = 1 time/sec
1 = 4 times/sec
2 = 8 times/sec
3 = 16 times/sec
4 = 20 times/sec

5-1-14 "F13 0" BCD OUTPUT RATE

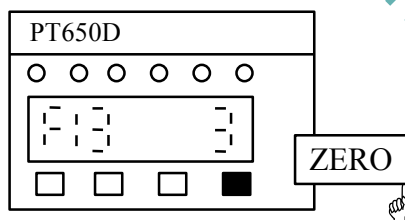
Press **TARE** key to select

0 = 4 times/sec
1 = 8 times/sec
2 = 16 times/sec
3 = 20 times/sec
4 = 60 times/sec
5 = 80 times/sec
6 = 100 times/sec
7 = 200 times/sec

Note: No need to set without BCD board.

5-1-15 "F14 0" RS485 ID CODE

Press **TARE** key to select

00 ~ 99

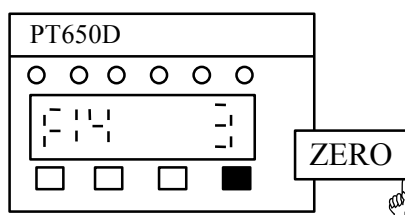

Note: This parameter will be activated only for RS485 option.

The ID code must not be the same as the other PT650D which connected to the same master device.

ID = 00, only single device communication.

5-1-16 "F15 0" PEAK HOLD

Press **TARE** key to select

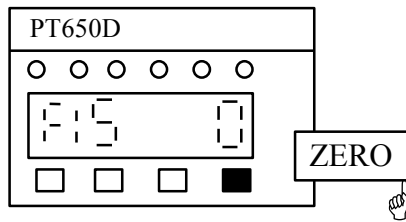

- 0 = Peak hold is not valid
- 1 = Peak hold(automatically)
- 2 = Valley hold(automatically)
- 3 = Peak – valley hold(automatically)
- 4 = Peak hold(external)
- 5 = Valley hold(external)
- 6 = Peak – valley hold(external)

Note: 4, 5 or 6 must be matched to “8 = Peak hold” of F16, F17 or F18.

5-1-17 "F16 0" INPUT 1

Press **TARE** key to select

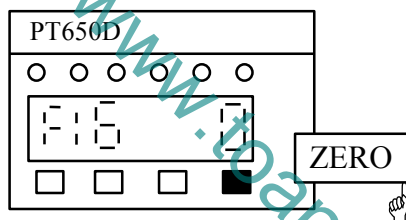

- 0 = Function
- 1 = Zero
- 2 = Tare
- 3 = Gross/Net
- 4 = Print
- 5 = kg/lb
- 6 = On/Off
- 7 = Hold
- 8 = Peak hold

5-1-18 "F17 0" INPUT 2

Press **TARE** key to select

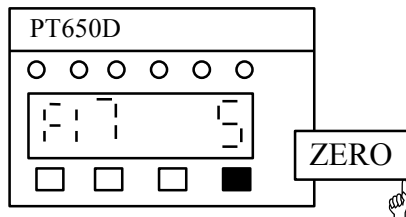

- 0 = Function
- 1 = Zero
- 2 = Tare
- 3 = Gross/Net
- 4 = Print
- 5 = kg/lb
- 6 = On/Off
- 7 = Hold
- 8 = Peak hold

5-1-19 "F18 0" INPUT 3

Press **TARE** key to select

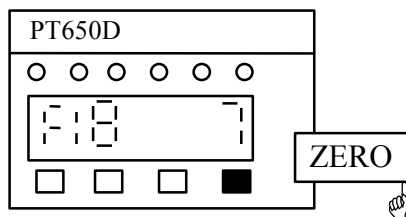

- 0 = Function
- 1 = Zero
- 2 = Tare
- 3 = Gross/Net
- 4 = Print
- 5 = kg/lb
- 6 = On/Off
- 7 = Hold
- 8 = Peak hold

5-1-20 "F19 0" COMPARISON CONDITION

Press **TARE** key to select

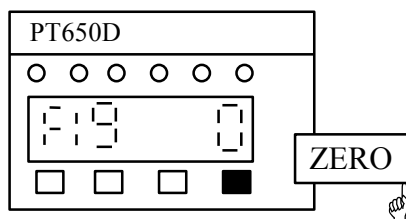

0 = Gross weight

1 = Net weight

2 = Display weight

Note: Comparison output according to F19 setting.

5-2 FUNCTION SETTING BY RS232/RS485 (only for RS232 or RS485 option is installed)

Function setting can be activated by using RS232/RS485. At normal weighing mode, from RS232 port, input a command "FUNC<CR><LF>", the gross display will show "FUNC".

From RS485 port, input a command "<ENQ>IDXX<CR><LF>", indicator responds "<ACK>XX<CR><LF>", then input a command "FUNC<CR><LF>", the gross display will show "FUNC".



Command input

<ENQ>IDXX<CR><LF> (RS485)
FUNC<CR><LF>

PT650D responds

<ACK>XX<CR><LF> (RS485)

5-2-1 ZERO TRACK TIME

Input 0 or 1, 0 = no zero track, 1 = 1 sec
1<CR><LF>

Input N for next setting
N<CR><LF>

Z.TRACK T=0<CR><LF>

Z.TRACK T=1<CR><LF>

5-2-2 ZERO TRACK BAND

Input 1, 2 or 4 step width
2<CR><LF>

Input N for next setting
N<CR><LF>

Z.TRACK D=1<CR><LF>

Z.TRACK D=2<CR><LF>

5-2-3 MOTION DETECTION

Input 1, 3, 5 or 10 step width
 3<CR><LF> MOTION 1D/S<CR><LF>
 Input N for next setting
 N<CR><LF> MOTION 3D/S<CR><LF>

5-2-4 DECIMAL POINT

Input 0, 1, 2, 3 or 4
 0 = no decimal
 1 = XXXX.X
 2 = XXX.XX
 3 = XX.XXX
 4 = X.XXXX D.P 4<CR><LF>
 Input N for next setting
 N<CR><LF> D.P 0<CR><LF>

5-2-5 MULTIPLIER (It is possible to modify the multiplier only when no decimal point is set)

Input 1 or 10
 10<CR><LF> MULT 1<CR><LF>
 Input N for next setting
 N<CR><LF> MULT 10<CR><LF>

5-2-6 DIVISION

Input 1, 2 or 5
 5<CR><LF> d 1<CR><LF>
 Input N for next setting
 N<CR><LF> d 5<CR><LF>

5-2-7 MAXIMUM CAPACITY

Input one of the 22 selection of maximum capacity between 500 to 100,000
 3500<CR><LF> MAX.CAP 500<CR><LF>
 100000<CR><LF> NO ? <CR><LF>
 Input N for next setting
 N<CR><LF> MAX.CAP 100000<CR><LF>

If there is any error in the maximum capacity, step width and multiplier, error message "ERROR 1" will be sent out, PT650D will return to 5-2-4.

5-2-8 RS232/RS485 BAUD RATE

Input 2400, 4800, 9600 or 19200	BAUD 2400<CR><LF>
9600<CR><LF>	BAUD 9600<CR><LF>
Input N for next setting	
N<CR><LF>	

5-2-9 UNIT

Input kg or t, kg = kg, t = ton	UNIT kg<CR><LF>
t<CR><LF>	UNIT t<CR><LF>
kg<CR><LF>	UNIT kg<CR><LF>
Input N for next setting	
N<CR><LF>	

5-2-10 ZERO RETURN RANGE

Input 1 to 10	Z.RANGE 1<CR><LF>
3<CR><LF>	Z.RANGE 3<CR><LF>
Input N for next setting	
N<CR><LF>	

5-2-11 DIGITAL FILTER

Input one of the 10 selection of digital filtering between 0 to 512	D.FILTER 0<CR><LF>
4<CR><LF>	D.FILTER 4<CR><LF>
Input N for next setting	
N<CR><LF>	

5-2-12 DISPLAY UPDATE RATE

Input 1, 4, 8, 16 and 20 times/sec	DSP RATE 1<CR><LF>
4<CR><LF>	DSP RATE 4<CR><LF>
Input N for next setting	
N<CR><LF>	

5-2-13 BCD OUTPUT RATE

Input 4, 8, 16, 20, 60, 80, 100 and 200 times/sec	BCD RATE 4<CR><LF>
8<CR><LF>	BCD RATE 8<CR><LF>
Input N for next setting	
N<CR><LF>	

5-2-14 ID CODE

Input 00 to 99	ID. NO. 00<CR><LF>
01<CR><LF>	ID. NO. 01<CR><LF>
Input N for next setting	
N<CR><LF>	

5-2-15 PEAK HOLD

PEAK HOLD OFF<CR><LF>
 Input OFF, PEAK AUTO, VALLEY AUTO,
 PEAK VALLEY AUTO, PEAK EXT,
 VALLEY EXT and PEAK VALLEY EXT
 PEAK AUTO<CR><LF> PEAK AUTO<CR><LF>
 Input N for next setting
 N<CR><LF>

5-2-16 INPUT 1

INPUT1 FUNC<CR><LF>
 Input FUNC, ZERO, TARE, G/N, PRINT, kg/lb,
 ON/OFF, HOLD and PEAK HOLD
 FUNC<CR><LF> INPUT1 FUNC<CR><LF>
 Input N for next setting
 N<CR><LF>

5-2-17 INPUT 2

INPUT2 PEAK HOLD<CR><LF>
 Input FUNC, ZERO, TARE, G/N, PRINT, kg/lb,
 ON/OFF, HOLD and PEAK HOLD
 kg/lb<CR><LF> INPUT2 kg/lb<CR><LF>
 Input N for next setting
 N<CR><LF>

5-2-18 INPUT 3

INPUT3 PRINT<CR><LF>
 Input FUNC, ZERO, TARE, G/N, PRINT, kg/lb,
 ON/OFF, HOLD and PEAK HOLD
 HOLD<CR><LF> INPUT3 HOLD<CR><LF>
 Input N for next setting
 N<CR><LF>

5-2-19 COMPARISON CONDITION

COMPARISON GROSS<CR><LF>
 Input GROSS, NET and DISPLAY
 DISPLAY<CR><LF> COMPARISON DISPLAY<CR><LF>
 Input R to return to normal weighing mode
 R<CR><LF> YES<CR><LF>

Note: When maximum capacity, division or multiplier is changed, system must be calibrated again and reset the Hi/Lo setpoint, the display of PT650D will show "CAL1".

6. CALIBRATION

- * Zero tracking can not be performed at calibration.
- * The weighing data can be accepted only when motion is not detected in calibration.
- * When an error occurs, error message will output from RS232/RS485.

6-1 DURING SPAN SETTING

1. Span setting when step width and multiplier are set.

STEP WIDTH

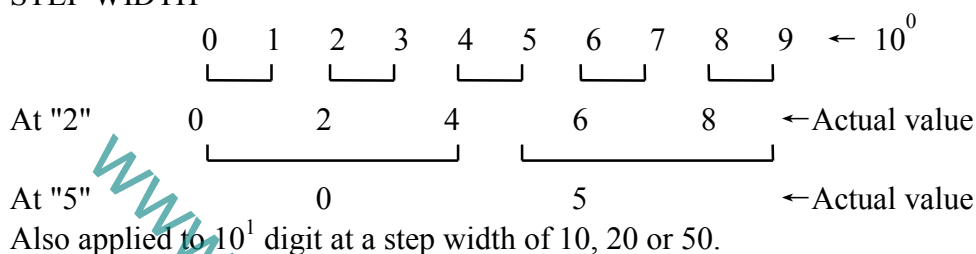

2. When multiplier is set to × 10, no 10⁰ digit can be set.
3. When multiplier, maximum capacity or step width is changed or check sum error occurs, the setting can not quit by pressing the MODE key (data must be reset).

6-2 SETTING STEPS

6-2-1 CALIBRATION 1 (by using standard weight)

Press and hold MODE key, then press TARE key, 2 seconds later, display "CAL 1", and enter the calibration 1.

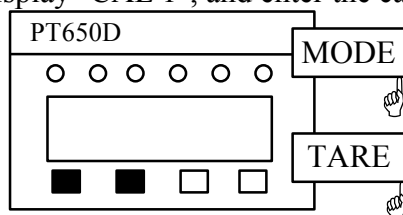

2 seconds later, enter the calibration 1

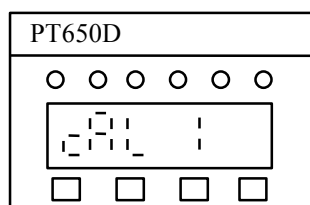

Press ZERO key, display as follows, and enter the zero calibration.

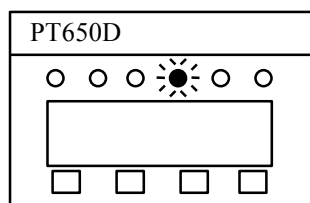

1. ZERO CALIBRATION

Zero calibration 1 (according to the last zero)

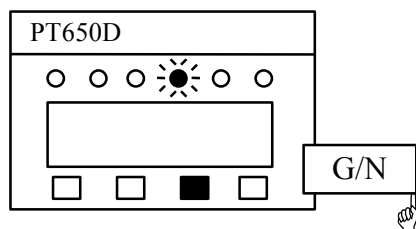

If there is not necessary to calibrate the zero offset, press **ZERO** key and **G/N** key to skip the zero calibration procedure, and enter the next setting.

Zero calibration 2 (calibrate the new zero)

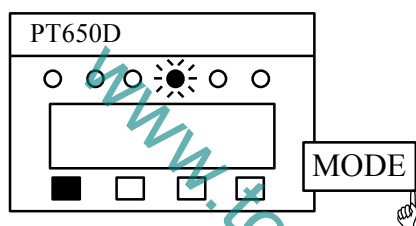

Calibrate zero offset, press the **ZERO** key and **MODE** key to accept the tare value equals to 0.

2. SPAN CALIBRATION

Span calibration 1 (according to the last span)

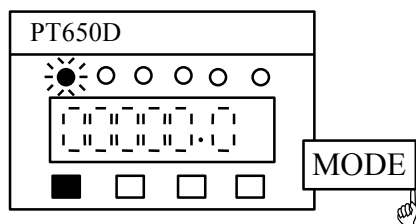

After performing the zero calibration without error, the indicator will display “**MODE**”. Press **MODE** key to return to normal weighing condition if only zero adjustment is required.

Span calibration 2 (calibrate the new span)

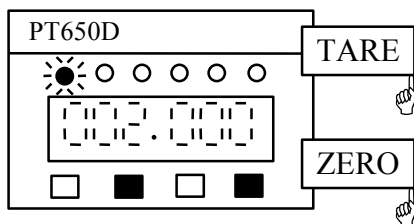

Put the standard weight which equals to the scale capacity to the weighing platform, use the **ZERO** key and the **TARE** key to set the reading of the indicator exactly the same as the value of the standard weight, press **MODE** key to perform the calibration.

Note: The minimum weight required is 100 division.

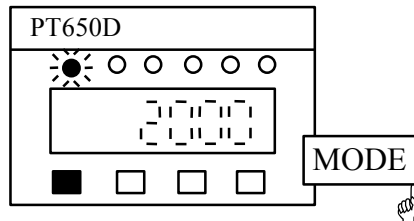

6-2-2 CALIBRATION 2 (data input)

Press and hold **MODE** key, then press **TARE** key, 2 seconds later, display "CAL 1", then press **TARE** key, display "CAL 2", and enter the calibration 2.

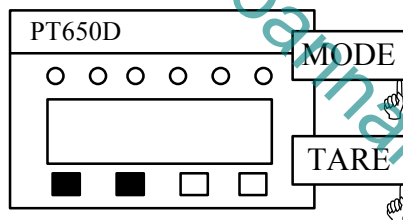

2 seconds later,

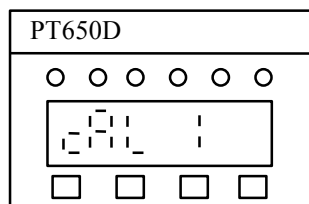

Press **TARE** key, displays "CAL 2", and enter the calibration 2.

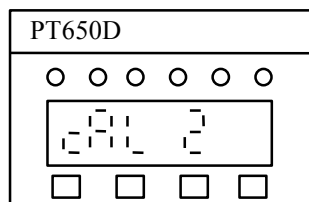

Press **ZERO** key, and enter the zero calibration.

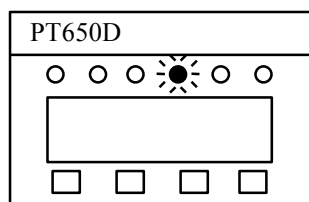

1. ZERO CALIBRATION

Zero calibration 1(according to the last zero)

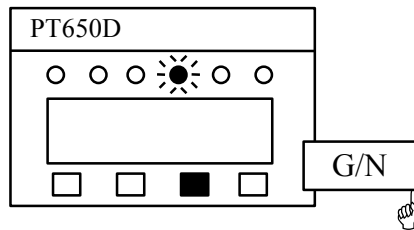

If there is not necessary to calibrate the zero offset, press **ZERO** and **G/N** keys to skip the zero calibration procedure, enter the next setting.

Zero calibration 2(calibrate the new zero)

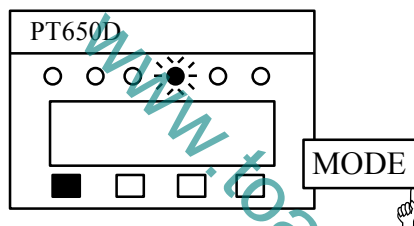

Calibrate zero offset, press the **ZERO** and **MODE** keys to accept the tare value equals to 0.

2. SPAN CALIBRATION

Voltage setting

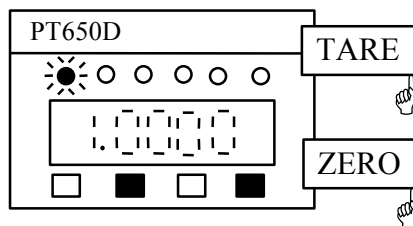

After performing the zero calibration without error, the indicator will display "1.1.1.1.1.1.1.1.1.1", input the value(unit: mV/V)of (max. capacity – voltage value at zero)by **ZERO** and **TARE** keys when “gross” annunciator is flashing.

Example: Zero = 0.1001mV/V

Max. capacity = 1.9998 mV/V

Input = 1.8997 mV/V.

Span calibration

Press **[G/N]** key to enter span calibration, or press **[MODE]** key to return to normal weighing mode.

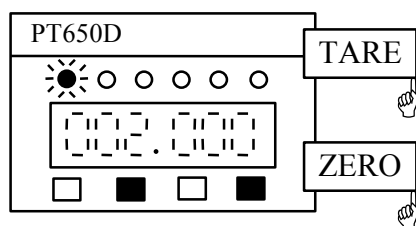

Press **[ZERO]** and **[TARE]** keys to enter span value when “gross” annunciator is lit steady, and press **[MODE]** key to perform span calibration.
Note: The minimum weight required is 100 division.

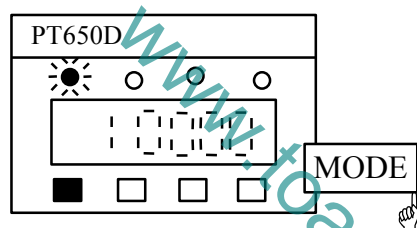

6-3 ERROR CODE DURING CALIBRATION

- ERROR 1 : Incorrect setting for multiplier, division, or maximum capacity.
- ERROR 2 : Incorrect wiring between load cell and indicator, voltage for zero value is greater than the voltage for span value.
- ERROR 3 : Input voltage too low.
The dead weight of the weighing platform may be too light.
Add a 1% metal film resistor of $50\text{K}\Omega$ to $500\text{K}\Omega$ between EX+ and SG+.
- ERROR 4 : Input voltage too high
The dead weight of the weighing platform may be too heavy.
Add a 1% metal film resistor of $50\text{K}\Omega$ to $500\text{K}\Omega$ between EX + and SG-.
- ERROR 5 : Input sensitivity of load cell is out of range.
- ERROR 6 : Load cell output voltage at scale capacity is too high.
- ERROR 7 : Zero offset is greater than zero return range.

6-4 CALIBRATION BY USING RS232/RS485(only for RS232 or RS485 option is installed)

6-4-1 Calibration function can be activated by using RS232/RS485

At normal weighing mode, from RS232 port, input a command “CAL 1<CR><LF>”, the gross display will show “CAL1”.

From RS485 port, input a command “<ENQ>IDXX<CR><LF>”, indicator respond “<ACK>XX<CR><LF>”, then input a command “CAL 1<CR><LF>”, the gross display will show “CAL1”.

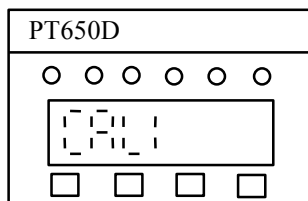

Command input

<ENQ>IDXX<CR><LF> (RS485)
CAL 1<CR><LF>

PT650D response

<ACK>XX<CR><LF> (RS485)

1. ZERO CALIBRATION

CAL ZERO<CR><LF>

Input N,R or J

N = Perform a zero offset calibration

R = Return to normal weighing condition without any adjustment.

J = Skip the zero offset calibration.

Note: If maximum capacity, division or multiplier was changed and no calibration is performed after the modification, then the R command will be invalid.

Input N to perform zero offset calibration when there is no motion detected and no load on the weighing platform.

N<CR><LF>

Error 3<CR><LF>

N<CR><LF>

Error 4<CR><LF>

Error 3 : Input voltage too low.

The dead weight of the weighing platform may be too light.

Add a 1% metal film resistor of 50K Ω to 500K Ω between EX+ and SG+.

Error 4 : Input voltage too high.

The dead weight of the weighing platform may be too heavy.

Add a 1% metal film resistor of 50K Ω to 500K Ω between EX+ and SG-.

N<CR><LF>

YES<CR><LF>

YES = Zero offset calibration is performed.

2. SPAN CALIBRATION

After performing the zero calibration without error, the message “YES” and “CAL SPAN” will be sent out.

Input R to return to normal weighing condition, and system was only performed a zero offset calibration.

Note: If maximum capacity, division or multiplier was changed and no calibration is performed after the modification, the “R” command will be invalid.

```
10000<CR><LF>           Error  2<CR><LF>
5000<CR><LF>             Error  6<CR><LF>
20000<CR><LF>           Error  1<CR><LF>
```

Error 1 : Incorrect setting for multiplier, division or maximum capacity.

Error 2 : Incorrect wiring between load cell and indicator.

Voltage for zero value is greater than the voltage for span value.

Error 5 : Input sensitivity of load cell is out of range.

Error 6 : Load cell output voltage at scale capacity is too high.

```
100000<CR><LF>          CAL SPAN 100000<CR><LF>
                          YES<CR><LF>
```

YES = Calibration completed

Input “R” command to return to normal weighing condition.

6-4-2 Calibration function can be performed by entering the sensitivity via RS232/RS485

At normal weighing mode, from RS232 port, input a command “CAL2<CR><LF>”, the gross display will show “CAL2”.

From RS485 port, input a command “<ENQ>IDXX<CR><LF>”, indicator respond “<ACK>XX<CR><LF>”, then input a command “CAL2<CR><LF>”, the gross display will show “CAL2”.

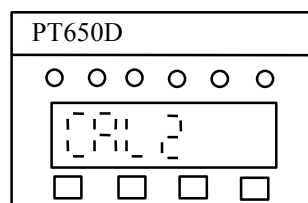

Command
<ENQ>IDXX<CR><LF> (RS485)
CAL2<CR><LF>

PT650D response
<ACK>XX<CR><LF> (RS485)

1. ZERO CALIBRATION

CAL ZERO<CR><LF>

Input N, R or J

N = Perform a zero offset calibration

R = Return to normal weighing condition without any adjustment.

J = Skip the zero offset calibration.

Note: If maximum capacity, division or multiplier was changed and no calibration is performed after the modification, then the R command will be invalid.

Input N to perform zero offset calibration when there is no motion detected and no load on the weighing platform.

N<CR><LF>

Error 3<CR><LF>

N<CR><LF>

Error 4<CR><LF>

Error 3: Input voltage too low.

The dead weight of the weighing platform may be too light.
Add a 1% metal film resistor of $50K\Omega$ to $500K\Omega$ between EX+ and SG+.

Error 4 : Input voltage too high.

The dead weight of the weighing platform may be too heavy.
Add a 1% metal film resistor of $50K\Omega$ to $500K\Omega$ between EX+ and SG-.

N<CR><LF>

YES<CR><LF>

SPIN 1.5000 mV/V<CR><LF>

2. Span voltage setting

After performing the zero calibration without error, the message “YES” and “SPIN 1.5000mV/V” will be sent out.

Input “R” command to return to normal weighing condition.

10000<CR><LF>

SPIN 1.0000mV/V<CR><LF>

Note: input value = (span voltage – zero voltage) / excitation voltage

3. SPAN CALIBRATION

After setting completion, input “N” to enter span setting

N<CR><LF>

SPAN 1000<CR><LF>

1500<CR><LF>

SPAN 1500<CR><LF>

Input “R” command to return to the normal weighing condition.

R<CR><LF>

YES<CR><LF>

7. DISPLAYED VALUES AND OUTPUT VALUES

The relationship between gross, net and maximum display values are as follows. Those values are applied to BCD and RS232/RS485 output.

- (1) Gross display value = Gross value \times (step width \times multiplier)
 TARE function will be accepted when motion is not detected.
- (2) Net display value = Gross value – tare value
 TARE function will not be accepted when gross display value is less than zero.
- (3) Maximum display value = Maximum capacity + (9 \times step width \times multiplier)

When the gross value exceeds the maximum displayed value (even when the net displayed value is being displayed), the indicator displays “O.L”, and displays the gross value when the loading is within weighing range.

8. SETTING THE SETPOINT

- (1) All data are gross display value.
- (2) Shifts to the higher digit every time from 10^0 digit to 10^4 digit by pressing the **ZERO** key.
Shifts to a greater value every time from 0 to 9 by pressing the **TARE** key.
- (3) Set the 10^0 or 10^1 digit, independently of step width or multiplier.
- (4) Display the data from HH to LL one by one through the indicator.

	▼	▼	▼	▼
Display:	GROSS	NET	MOTION	ZERO
Comparison setpoint:	HH	HI	LO	LL

8-1 SETTING SETPOINT

Enter the comparison setpoint setting: Press and hold **MODE** key, then press **ZERO** key, 2 seconds later, displays "SET".

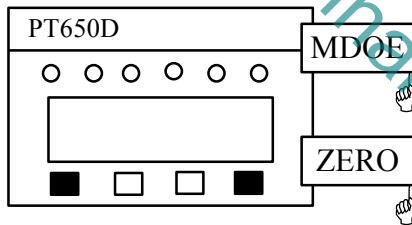

2 seconds later

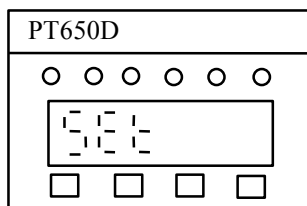

2 seconds later

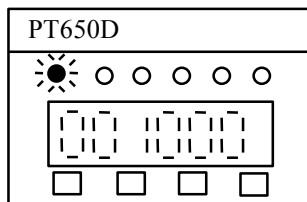

Step 1: HIGH HIGH setpoint setting (HH)

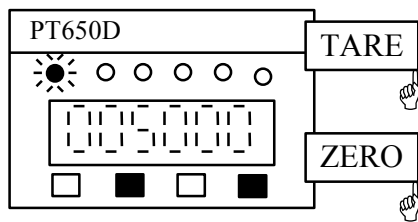

The display value is HH setpoint when the annunciator of GROSS is lit, select digit by pressing **ZERO** key and set the data by pressing **TARE** key.

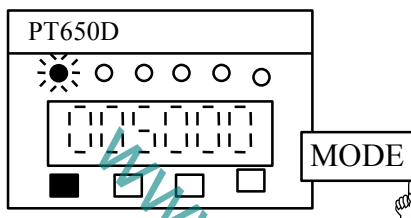

Accept the data by pressing **MODE** key, and enter the step 2.

Step 2: HIGH setpoint setting (HI)

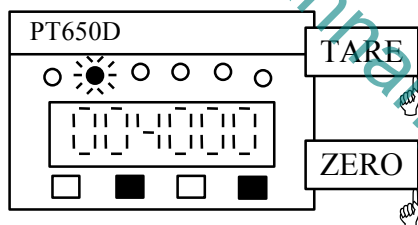

The display value is HI setpoint when the annunciator of NET is lit, select digit by pressing **ZERO** key and set the data by pressing **TARE** key.

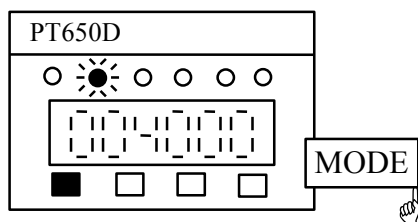

Accept the data by pressing **MODE** key, and enter the step 3.

Step 3: LOW setpoint setting (LO)

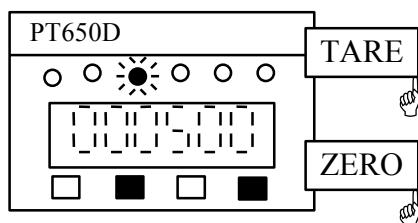

The display value is LOW setpoint when the annunciator of MOTION is lit, select digit by pressing **ZERO** key and set the data by pressing **TARE** key.

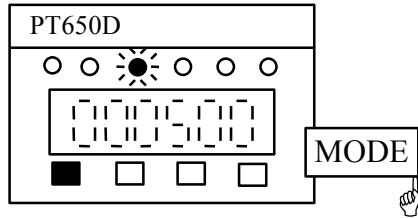

Accept the data by pressing **MODE** key, and enter the step 4.

Step 4: LOW LOW setpoint setting (LL)

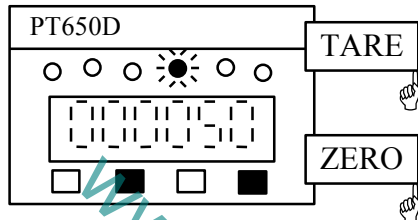

The display value is LL setpoint when the annunciator of ZERO is lit, select digit by pressing **ZERO** key and set the data by pressing **TARE** key.

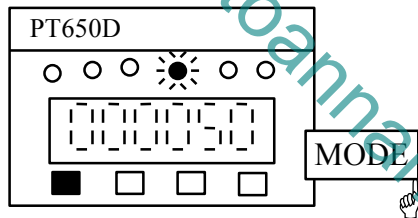

Accept the data by pressing **MODE** key.

Step 5: HIGH HIGH hysteresis setpoint setting (HH-S)

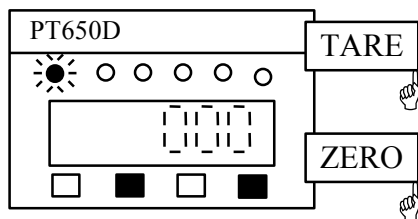

The display value is HH-S setpoint when the annunciator of GROSS is flashing, select digit by pressing **ZERO** key and set the data by pressing **TARE** key.

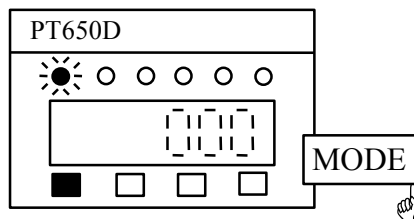

Accept the data by pressing **MODE** key, and enter the step 6.

Step 6: HIGH hysteresis setpoint setting (HI-S)

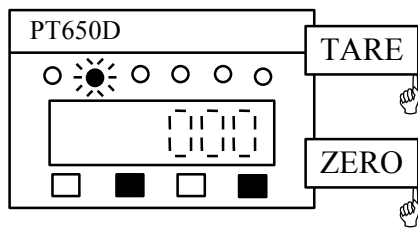

The display value is HH-S setpoint when the annunciator of NET is flashing, select digit by pressing **ZERO** key and set the data by pressing **TARE** key.

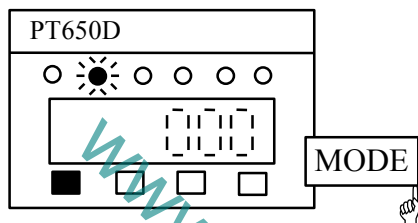

Accept the data by pressing **MODE** key, and enter the step 7.

Step 7: LOW hysteresis setpoint setting (LO-S)

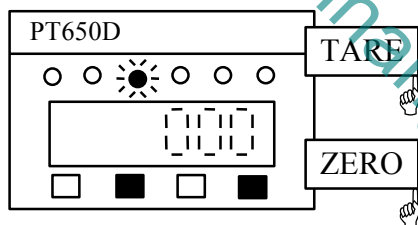

The display value is LO-S setpoint when the annunciator of MOTION is flashing, select digit by pressing **ZERO** key and set the data by pressing **TARE** key.

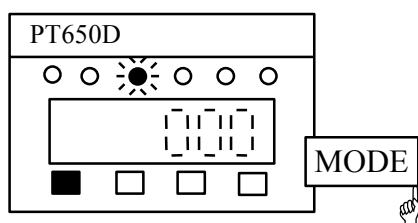

Accept the data by pressing **MODE** key, and enter the step 8.

Step 8: LOW LOW hysteresis setpoint setting (LL-S)

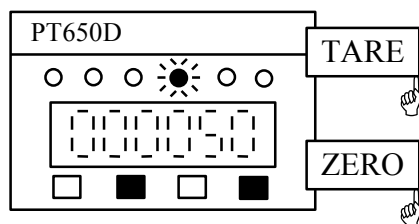

The display value is LL-S setpoint when the annunciator of ZERO is flashing, select digit by pressing **ZERO** key and set the data by pressing **TARE** key.

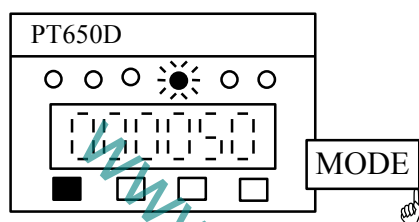

Accept the data by pressing **MODE** key.

Step 9: Exit the comparison setting

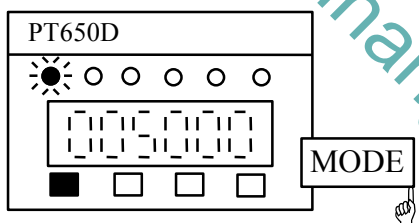

Press **MODE** key to return to normal weighing mode.

An error will occur if the setting condition is not satisfied:

$HH \geq HI \geq LO \geq LL$, press **MODE** key to restart from step 1 to step 4.

Note: If one of the setpoint value is zero then the value will not be used for comparison. For example: $HH = 00$, then "HH" is invalid.

8-2 SETTING SETPOINT BY USING RS232/RS485 (only for RS232 or RS485 option is installed)

Comparison setpoint can be activated by using RS232/RS485.

At normal weighing mode,

From RS232 port, input a command "SET <CR><LF>", the gross display will show "SET".

From RS485 port, input a command "<ENQ>IDXX<CR><LF>", indicator responds "<ACK>XX<CR><LF>", then input a command "SET <CR><LF>", the gross display will show "SET".

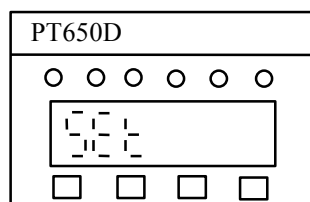

Command input	PT650D response
<ENQ>IDXX<CR><LF> (RS485)	<ACK>XX<CR><LF> (RS485)
SET<CR><LF>	S-HH 0<CR><LF>
Step 1: HIGH HIGH setpoint setting (HH)	
4000<CR><LF>	S-HH 4000<CR><LF>
Input N for next step	
N<CR><LF>	S-HI 0<CR><LF>
Step 2: HIGH setpoint setting (HI)	
3000<CR><LF>	S-HI 3000<CR><LF>
Input N for next step	
N<CR><LF>	S-LO 0<CR><LF>
Step 3: LOW setpoint setting (LO)	
100<CR><LF>	S-LO 100<CR><LF>
Input N for next step	
N<CR><LF>	S-LL 0<CR><LF>
Step 4: LOW LOW setpoint setting (LL)	
40<CR><LF>	S-LL 40<CR><LF>
Input N for next step	
N<CR><LF>	HH-S 400<CR><LF>
Step 5: HIGH HIGH hysteresis setpoint setting (HH-S)	
50<CR><LF>	HH-S 50<CR><LF>
Input N for next step	
N<CR><LF>	HI-S 40<CR><LF>

Step 6: HIGH hysteresis setpoint setting (HI-S)

50<CR><LF>

HI-S 50<CR><LF>

Input N for next step

N<CR><LF>

LO-S 30<CR><LF>

Step 7: LOW hysteresis setpoint setting (LO-S)

20<CR><LF>

LO-S 20<CR><LF>

Input N for next step

N<CR><LF>

LL-S 30<CR><LF>

Step 8: LOW LOW hysteresis setpoint setting (LL-S)

20<CR><LF>

LL-S 20<CR><LF>

Input N for next step

N<CR><LF>

S-HH 4000<CR><LF>

An error will occur if the setting condition is not satisfied:

$HH \geq HI \geq LO \geq LL$, press N<CR><LF> to restart from step 1 to step 8.

If one of the setpoint value is zero then the value will not be used for comparison.

Step 9: Return to normal weighing mode

Press R to return to the normal weighing mode

R<CR><LF>

YES<CR><LF>

www.toamanggroup.com.vn

9. OUTPUT/INPUT

9-1 COMPARISON OUTPUT(OPTION)

9-1-1 COMPARISON CONDITION

- 1) If comparison condition F19 = 0,
 - HH output on = gross weight value > HH setpoint
 - HI output on = gross weight value > HI setpoint
 - LO output on = gross weight value < LO setpoint
 - LL output on = gross weight value < LL setpoint

- 2) If comparison condition F19 = 1,
 - HH output on = net weight value > HH setpoint
 - HI output on = net weight value > HI setpoint
 - LO output on = net weight value < LO setpoint
 - LL output on = net weight value < LL setpoint

- 3) If comparison condition F19 = 2,
 - When displays gross weight value,
 - HH output on = gross weight value > HH setpoint
 - HI output on = gross weight value > HI setpoint
 - LO output on = gross weight value < LO setpoint
 - LL output on = gross weight value < LL setpoint
 - When displays net weight value,
 - HH output on = net weight value > HH setpoint
 - HI output on = net weight value > HI setpoint
 - LO output on = net weight value < LO setpoint
 - LL output on = net weight value < LL setpoint

9-1-2 COMPARISON RATE

200 times/sec

9-1-3 COMPARATOR OUTPUT DESCRIPTION

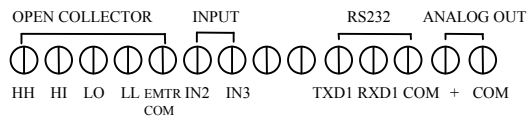

HH	High high setpoint
HI	High setpoint
LO	Low setpoint
LL	Low low setpoint
EMTR COM	Common of HH, HI, LO, LL

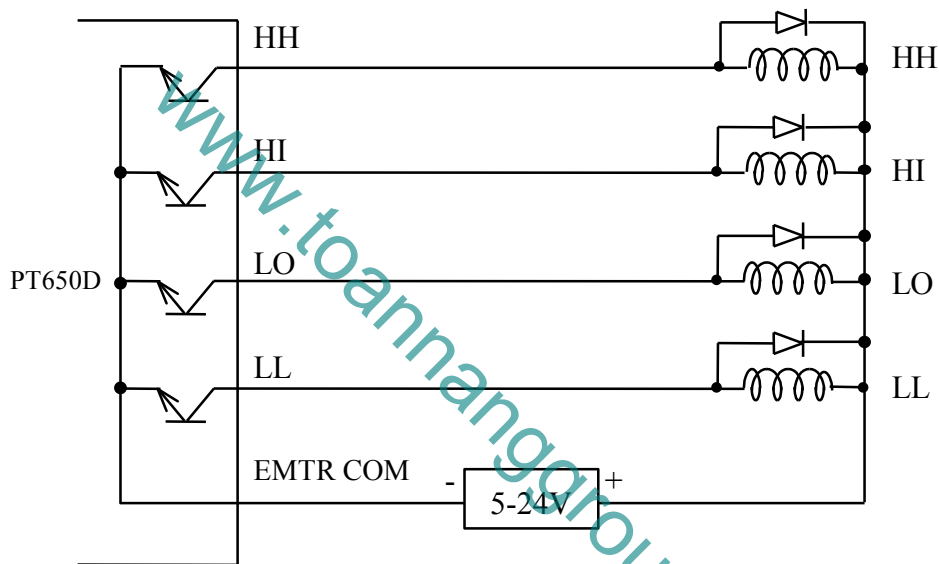

The output capacity is 5VDC to 24VDC and the max. current is 0.3A. Isolate PT650D from external controlled devices in order to reduce interference. Diode should be connected in parallel with the DC operated buffer relay to suppress any spark noise caused by contact switching.

9-1-4 COMPARISON OPTION

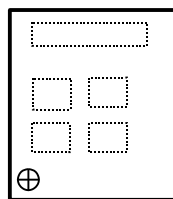

9-1-5 THE INSTALLATION OF COMPARISON OPTION

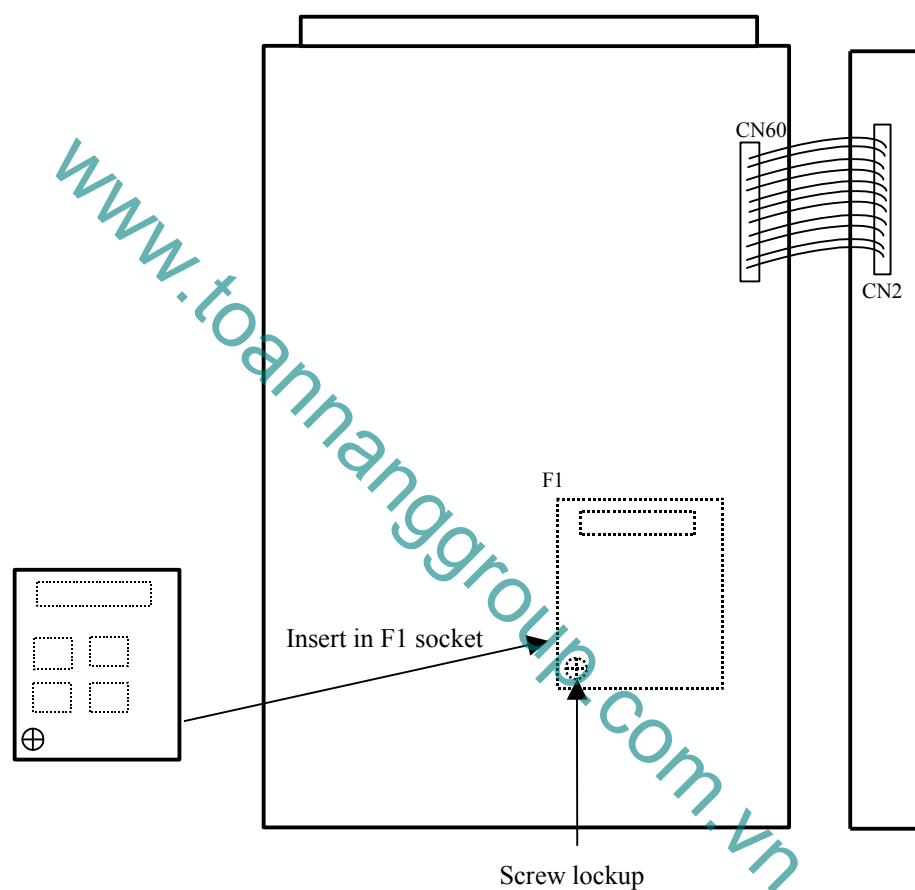

9-2 INPUT

9-2-1 INPUT CODE DESCRIPTION

0 = Function	When input terminal is open, the function setting and calibration procedure is invalid, When input terminal is short, the function setting and calibration procedure is valid. If other value is selected, the lock function is invalid.
1 = Zero	When the opto-coupler input is activated, this is the same function as pressing the ZERO key at the keyboard.
2 = Tare	When the opto-coupler input is activated, this is the same function as pressing the TARE key at the keyboard.
3 = Gross/Net	When the opto-coupler input is activated, this is the same function as pressing the G/N key at the keyboard.

4 = Print	When the opto-coupler input is activated, the displayed value will be sent via the RS232/RS485 serial port.
5 = kg/lb	When the opto-coupler input is activated, the displayed value will be changed in between the kg or lb.
6 = On/Off	When the opto-coupler input is activated, the display will be turned on or off.
7 = Hold	When the opto-coupler input is activated, the current measured value will be hold until the input is invalid.
8 = Peak hold	When the opto-coupler input is activated, and the corresponding peak, valley or peak – valley function, the weighing figure will be held until the peak hold input is invalid.

9-2-2 INPUT DESCRIPTION

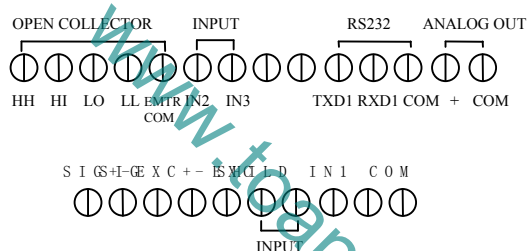

IN1 : Input 1
 IN2 : Input 2
 IN3 : Input 3
 COM : common of IN1, IN2, IN3

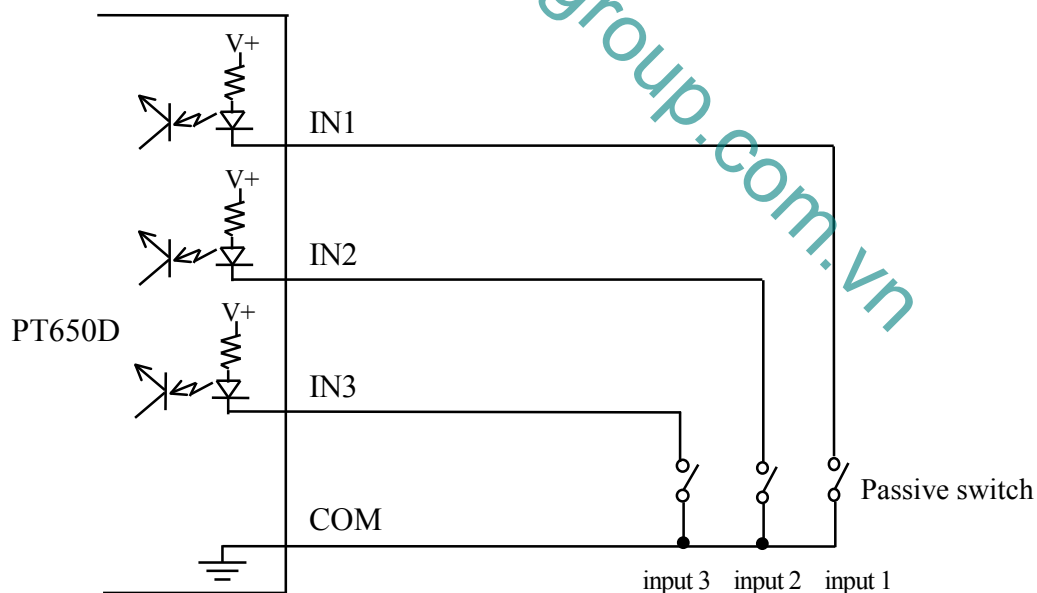

Note: The input contact is passive switch and short time is 30ms.

9-3 RS232/RS485 OUTPUT(OPTION)

9-3-1 RS232/RS485 DATA

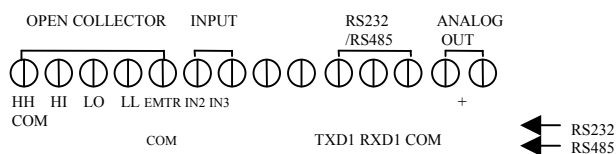

Baud rate : 2400, 4800, 9600, 19200
 Data bit : 7 bits
 Stop bit : 1 bit
 Parity bit : 1 (even)
 Code : ASCII
 Delimited : CR/LF

9-3-2 COMMUNICATION MODE

Continuous mode:

- (1) Output the weighing data continuously.
- (2) The output times according to the BCD setting times.
 Select 4, 8, 16 or 20 times/sec at 19200 baud.
 Select 4, 8, 16 or 20 times/sec at 9600 baud.
 Select 4 or 8 times/sec at 4800 and 2400 baud.

Command mode:

<u>Command input</u>	<u>PT650D response</u>	<u>Description</u>
READ<CR><LF>	ST,GS,+ 1234kg<CR><LF> ST,NT,+ 200kg<CR><LF>	. Weight data output, output gross data(GS) from RS232 when display gross weight, output net data(NT) from RS485 when display net weight.
TARE<CR><LF>	TARE 12345<CR><LF>	. Responds the tare value
TARE ON<CR><LF>	YES<CR><LF> or NO ? <CR><LF>	. Set tare
TARE OFF<CR><LF>	YES<CR><LF> or NO ? <CR><LF>	. Reset tare
TARE XXXX<CR><LF>	YES<CR><LF> or NO ? <CR><LF>	. Set tare (max. cap. \geq tare value)
ZERO<CR><LF>	ZERO 1234<CR><LF>	. Responds the zero Value

ZERO ON<CR><LF>	YES<CR><LF> or NO ? <CR><LF>	. Zero return range is 1 to 10 percentage of max. capacity, same as press “ZERO” key.
ZERO OFF<CR><LF>	YES<CR><LF> or NO ? <CR><LF>	. Reset the zero offset
KEY<CR><LF>	KEY ON<CR><LF> or KEY OFF<CR><LF>	. Key on or off
KEY ON<CR><LF>	YES<CR><LF> or NO ? <CR><LF>	. Key protection on (key function inhibit)
KEY OFF<CR><LF>	YES<CR><LF> or NO ? <CR><LF>	. Key protection off (key function enable)
PROG<CR><LF>	Command	. Set RS232 operation mode as command mode
CONT<CR><LF>	Command	. Set RS232 operation mode as continuous mode
FUNC<CR><LF>	Command	. Activate the function setting
CAL 1<CR><LF>	Command	. Activate the calibration setting
CAL2<CR><LF>	Command	. Activate the calibration setting
J<CR><LF>	Command	. Jump from zero calibration
SET<CR><LF>	Command	. Activate the setpoint setting
N<CR><LF>	Command	. Jump to next step, used with “FUNC”, “CAL”, and “SET”.
R<CR><LF>	Command	. Return to normal weighing condition, used with “FUNC”, “CAL” and “SET”.
<ENQ>IDXX<CR><LF>	Command	. Select the ID code for PT650D

9-3-3 WEIGHING DATA OUTPUT

Input "READ<CR><LF>" command after receiving the command from RS232/RS485, the output data is same as the data in continuous mode.

NO. 1 2 3 4 5 6 7 8 9 10 11 12 13 14 15 16 17 18

0 L , N T , - 1 2 3 4 . 5 7 k g CR LF

- NO. 1,2 : Status 1
: OL overload
: ST stable
: US unstable
- NO. 3 : "," 2C (HEX)
- NO. 4,5 : Status 2
: NT net weight
: GS gross weight
- NO. 6 : "." 2C (HEX)
- NO. 7 : Polarity
: "+" positive
: "-" negative
- NO. 8 - 14 : Weighing data
If there is no decimal point, position No.8 will replaced by a space.
- NO.15, 16 : Unit
kg, t
- NO.17, 18 : Control code
CR, LF

9-3-4 RS232 AND RS485 OPTION

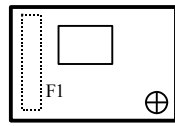

RS232

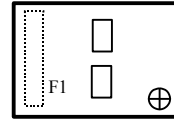

RS485

9-3-5 THE INSTALLATION OF RS232/RS485 OPTION

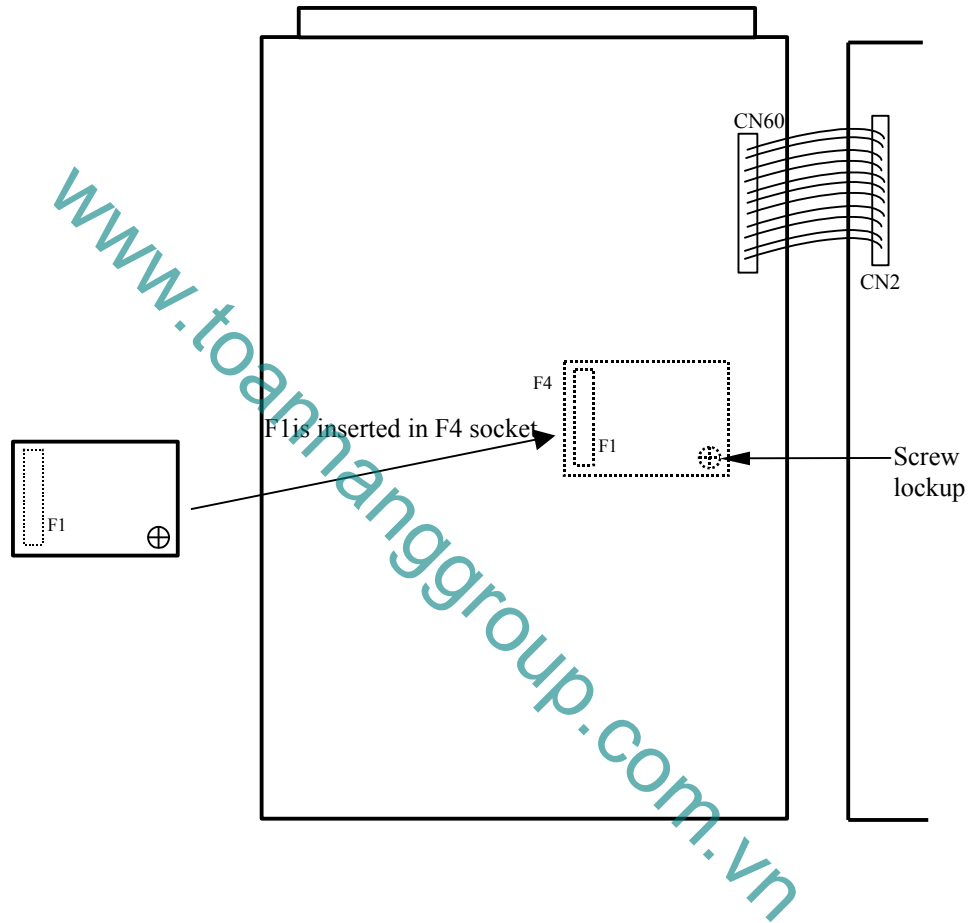

9-4 BCD DATA OUTPUT INTERFACE(OPTION)

9-4-1 PIN DESCRIPTION

Pin No.	Signal	Pin No.	Signal
1	BCD1	18	BCD20000
2	BCD2	19	BCD40000
3	BCD4	20	BCD80000
4	BCD8	21	BCD100000
5	BCD10	22	LO= Negative polarity
6	BCD20	23	LO= Overload
7	BCD40	24	Print
8	BCD80	25	LO= Gross
9	BCD100	26	LO= Motion detected
10	BCD200	27	LO= kg
11	BCD400	28	N.C.
12	BCD800	29	LO= Decimal point 1/10
13	BCD1000	30	LO= Decimal point 1/100
14	BCD2000	31	LO= Decimal point 1/1000
15	BCD4000	32	LO= Decimal point 1/10000
16	BCD8000	33	Ground
17	BCD10000	34	Ground

Numeric data(6 digits)	21 bits	(positive logic)
Polarity	1 bit	(LO = negative)
Overload	1 bit	(LO = overload)
Decimal point	4 bits	(LO = select digit)
GROSS/NET	1 bit	(LO = GROSS)
MOTION	1 bit	(LO = unstable)
PRINT COMMAND	1 bit	(positive pulse, 5ms)
UNIT	1 bits	(LO = kg)
Total 31 bits		

Note: The output period depends on function data.
Output even if data is out of the range.

9-4-2 BCD

2	8	2	8	2	8	2	8	2	8	POL	PRINT COM.	MOTION	N.C.	DP2	DP4	D.GND
2	4	6	8	10	12	14	16	18	20	22	24	26	28	30	32	34
1	3	5	7	9	11	13	15	17	19	21	23	25	27	29	31	33
$\frac{1}{10^0}$	$\frac{1}{10^1}$	$\frac{1}{10^2}$	$\frac{1}{10^3}$	$\frac{1}{10^4}$	$\frac{1}{10^5}$	OVER	GROSS/NET	UNIT	DP1	DP3	D.GND					

9-4-3 BCD OPTION

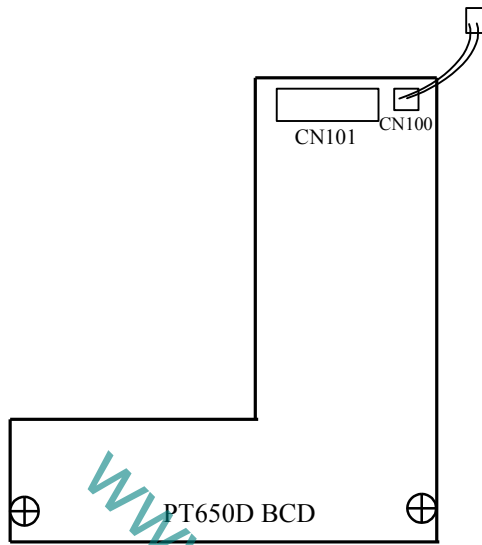

9-4-4 THE INSTALLATION OF BCD OPTION

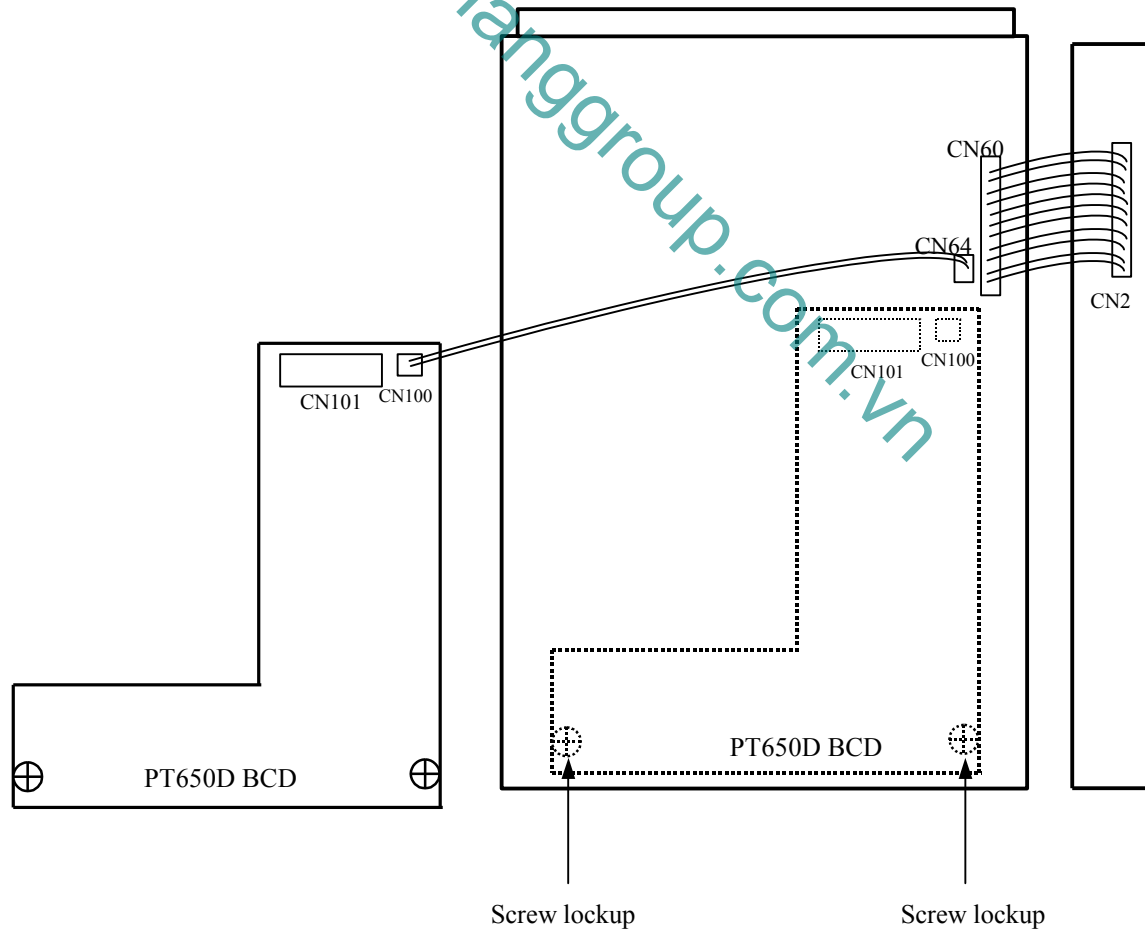

9-5 ANALOG OPTION

9-5-1 SPECIFICATION

Resolution : 1/10000
Accuracy : 0.5% F.S

Output	0~5V	0~20mA	4~20mA
load resistor	Min.10 K Ω	Max.500 Ω	Max.500 Ω
Output voltage/current when display value equals to 0	0V	0mA	4mA
Output voltage/current when display value equals to Max. capacity	5V	20mA	20mA

9-5-2 PIN No. DESCRIPTION

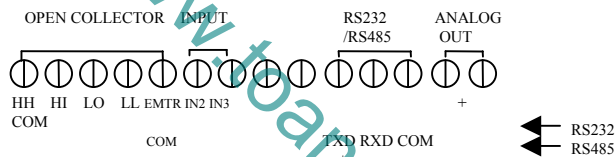

COM : Analog output -

+ : Analog output +

* The excitation current will be reduced to 120mA if the 0~20mA/4~20mA output board is used.

9-5-3 THE ANALOG OPTION

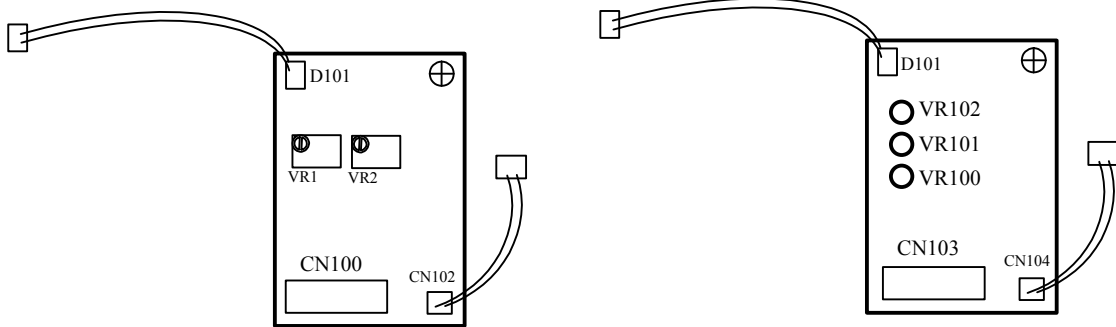

4~20mA/0~20mA analog option

Note: VR1 Zero adjust
VR2 Span adjust

0~5V analog option

Note: VR102 No need adjust
VR101 Span adjust
VR100 Zero adjust

9-5-4 THE INSTALLATION OF ANALOG OPTION

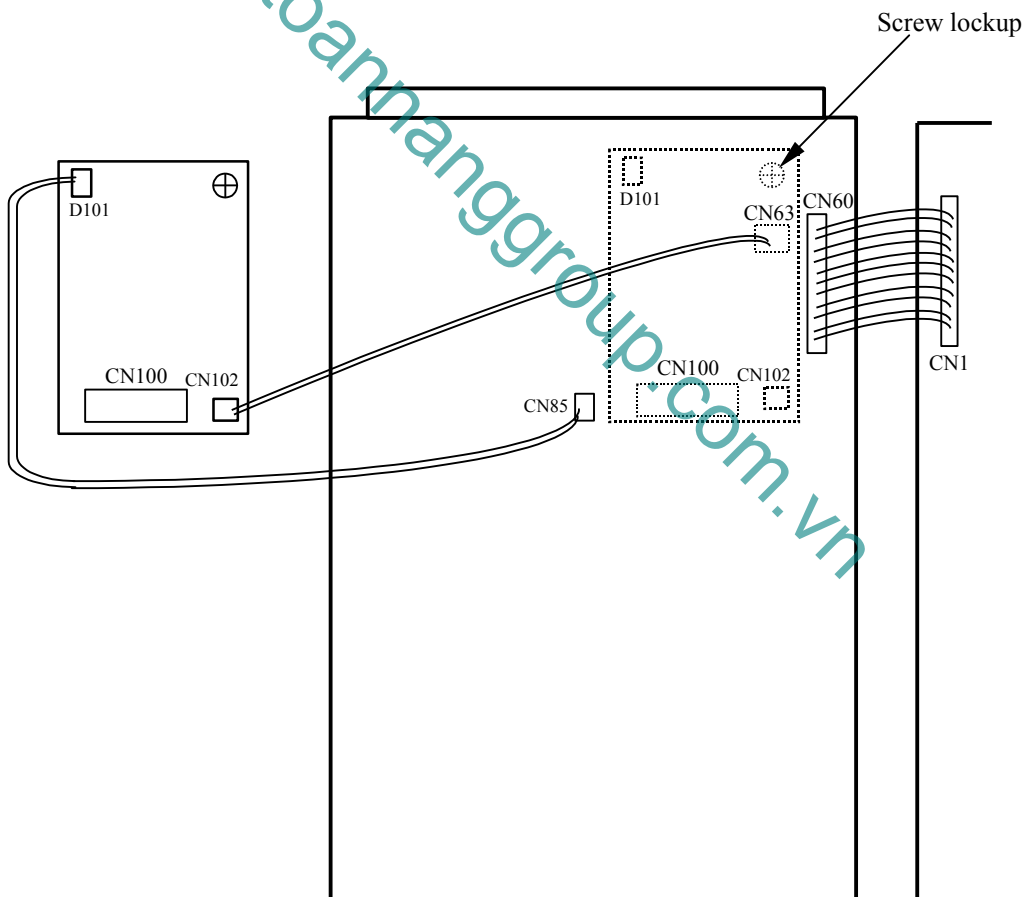

10. DIMENSION

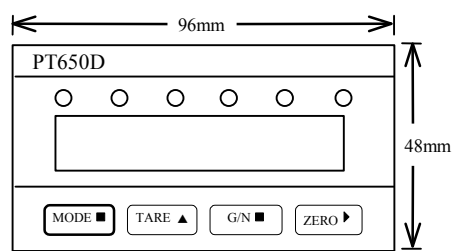

Front panel

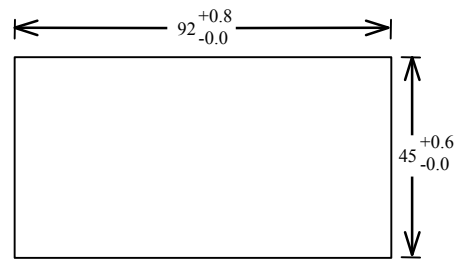

Panel cutout

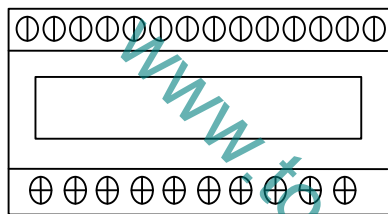

Rear panel

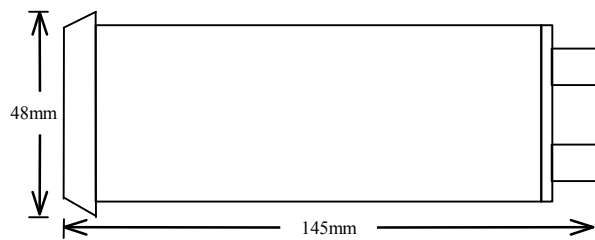

Side panel

www.tannanggroup.com.vn

11. APPENDIX

11-1 SINGLE MATERIAL BATCHING CONTROL SOFTWARE (OPTION)

This function will be deactivated if the software is not ordered.

Shifts to the higher digit every time from 10^0 digit to 10^4 digit by pressing the **ZERO** key.

Set the 10^0 or 10^1 digit, independent of step width or multiplier.

Shifts to a greater value every time from 0 to 9 by pressing the **TARE** key.

11-1-1 SETTING STEPS

Enter the single material batching setting: Press and hold **MODE**, then press **ZERO** key, 2 seconds later, displays "SET".

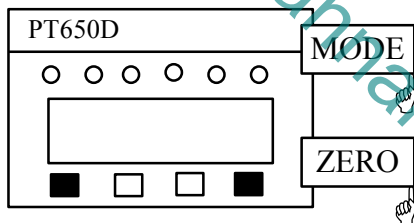

2 seconds later

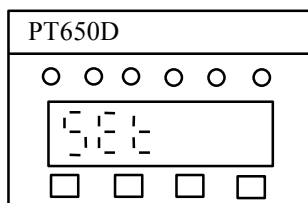

2 seconds later

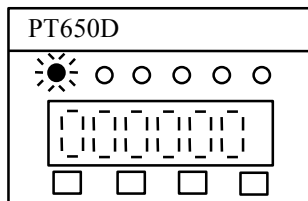

Step 1: Final setpoint setting

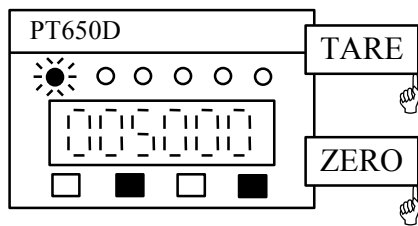

The display value is final setpoint when the annunciator of gross is flashing, select digit by pressing **ZERO** key and set the data by pressing **TARE** key.

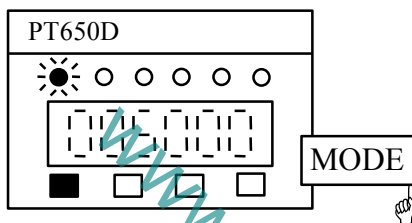

Accept the data by pressing **MODE** key.

Step 2: Optional preliminary setting(OP)

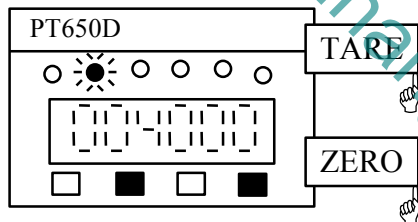

The display value is optional preliminary when the annunciator of net is flashing, select digit by pressing **ZERO** key and set the data by pressing **TARE** key.

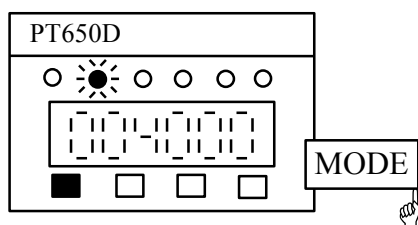

Accept the data by pressing **MODE** key.

Step 3: Preliminary setting(PL)

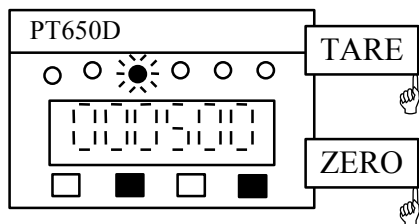

The display value is preliminary when the annunciator of motion is flashing, select digit by pressing **ZERO** key and set the data by pressing **TARE** key.

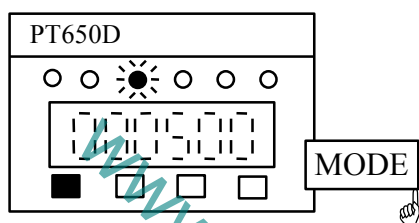

Accept the data by pressing **MODE** key.

Step 4: Free fall setting (FF)

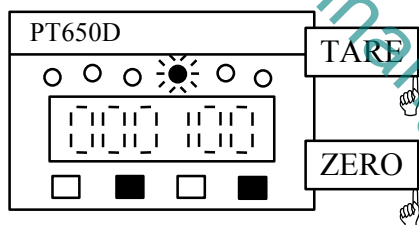

The display value is free fall when the annunciator of zero is flashing, select digit by pressing **ZERO** key and set the data by pressing **TARE** key.

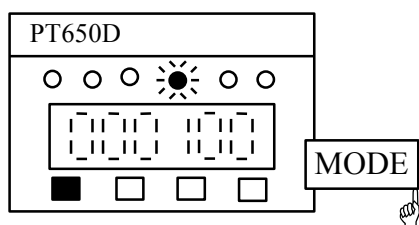

Accept the data by pressing **MODE** key.

Step 5: Zero band setting(ZB)

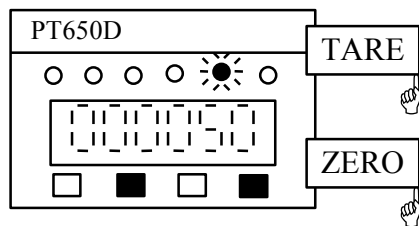

The display value is zero band when the annunciator of “kg” is flashing, select digit by pressing **ZERO** key and set the data by pressing **TARE** key.

Note: Zero band is independent of the above setting.

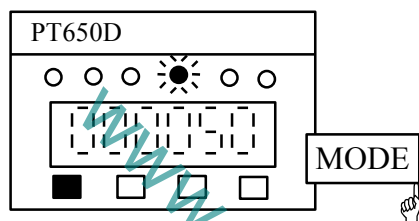

Accept the data by pressing **MODE** key.

Step 6: Exit the signal material batching setting

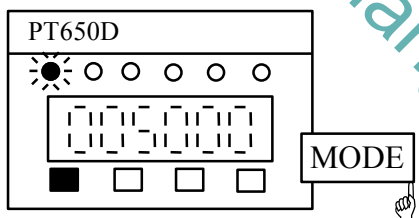

Press **MODE** key to return to the normal weighing mode.

An error will occur if the setting condition is not satisfied
 Final setpoint > Optional preliminary > Preliminary > Free fall,
 then press **MODE** key to restart from step 1 to step 5.

Net value \leq Zero band, ZB output

Zero band < Net value < Optional preliminary, no output

Optional preliminary \leq Net value < (Final – Preliminary), OP output

(Final – Preliminary) \leq Net value < (Final – Free fall), OP and PL output

(Final – Free fall) \leq Net value, OP, PL, FF output

11-1-2 SETTING BY USING RS232/RS485(only for RS232 or RS485 option is installed)

Setpoint setting can be activated by using RS232/RS485.

At normal weighing mode,

From RS232 port, input a command “SET<CR><LF>”, the gross display will show “SET”.

From RS485 port, input a command “<ENQ>IDXX<CR><LF>”, indicator responds “<ACK>XX<CR><LF>”, then input a command “SET <CR><LF>”, the gross display will show “SET”.

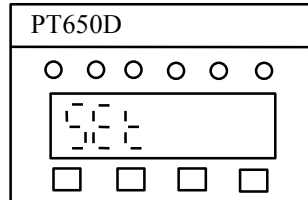

Command input	PT650D response
<ENQ>IDXX<CR><LF> (RS485) SET<CR><LF>	<ACK>XX<CR><LF> (RS485) FINAL 12340<CR><LF>
Step 1: Final setpoint setting 11200<CR><LF> Input N for next step N <CR><LF>	FINAL 11200<CR><LF> OP. PRE 200<CR><LF>
Step 2: Optional Preliminary setting (OP) 250<CR><LF> Input N for next step N<CR><LF>	OP. PRE 250<CR><LF> PRELIM 180<CR><LF>
Step 3: Preliminary setting (PL) 200<CR><LF> Press N for next step N<CR><LF>	PRELIM 200<CR><LF> FREE FALL 50<CR><LF>
Step 4: Free fall setting (FF) 30<CR><LF> Input N for next step N<CR><LF>	FREE FALL 30<CR><LF> ZERO BAND 55<CR><LF>
Step 5: Zero band setting (ZB) 35<CR><LF> Input N for next step N<CR><LF>	ZERO BAND 35<CR><LF> FINAL 11200<CR><LF>

An error will occur if the setting condition is not satisfied:

Final>Optional preliminary>Preliminary>Free fall, input "N <CR><LF>" to restart from step 1 to step 5.

Step 6: Exit the setting

Input R to return to normal weighing condition.

R<CR><LF>

YES<CR><LF>

For example:

Final setpoint = 1000

Optional prelim.(OP) = 500

Prelim.(PL) = 200

Free fall(FE) = 100

Zero band(ZB) = 50

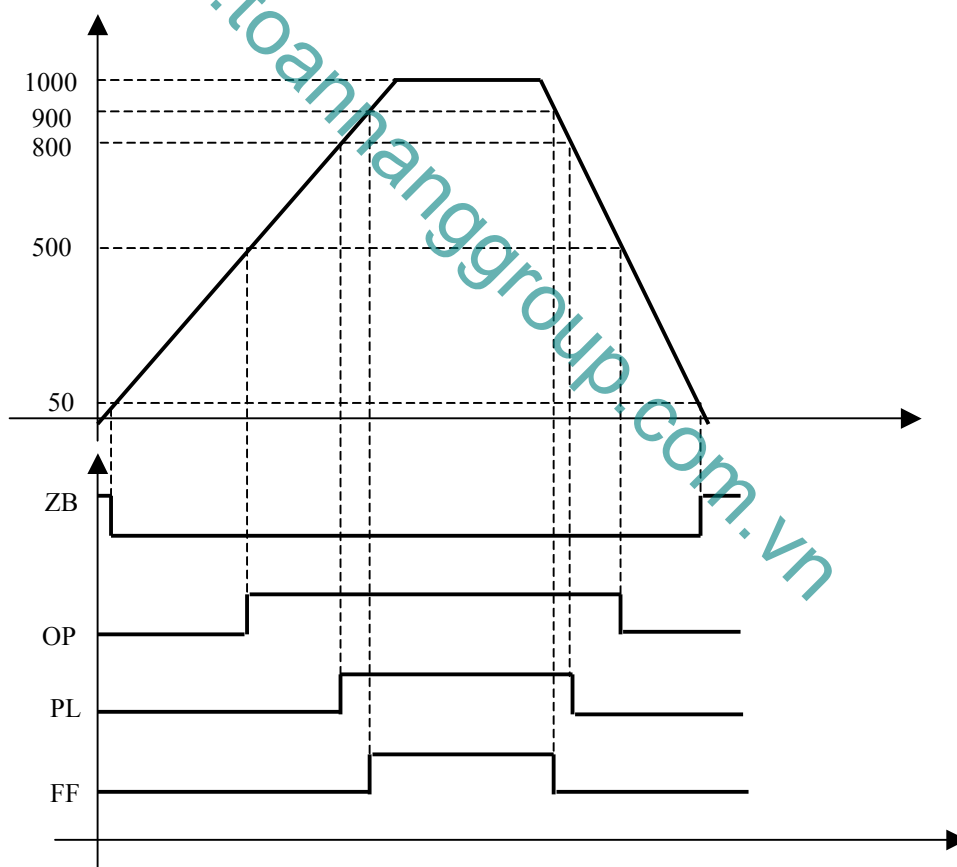

11-1-3 OUTPUT DESCRIPTION

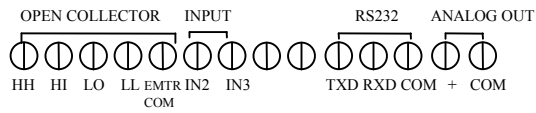

- OP(=HH) Optional preliminary
- PL(=HI) Preliminary
- FF(=LO) Free fall
- ZB(=LL) Zero band
- EMTR COM Common of OP, PL, FF, ZB

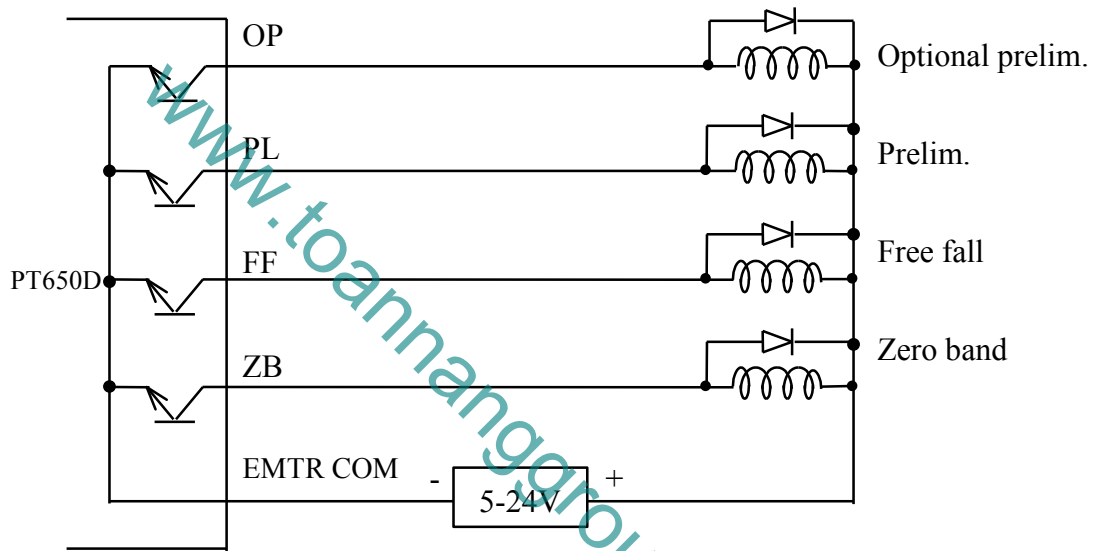

11-2 PT650D 110V AND 220V SETTING

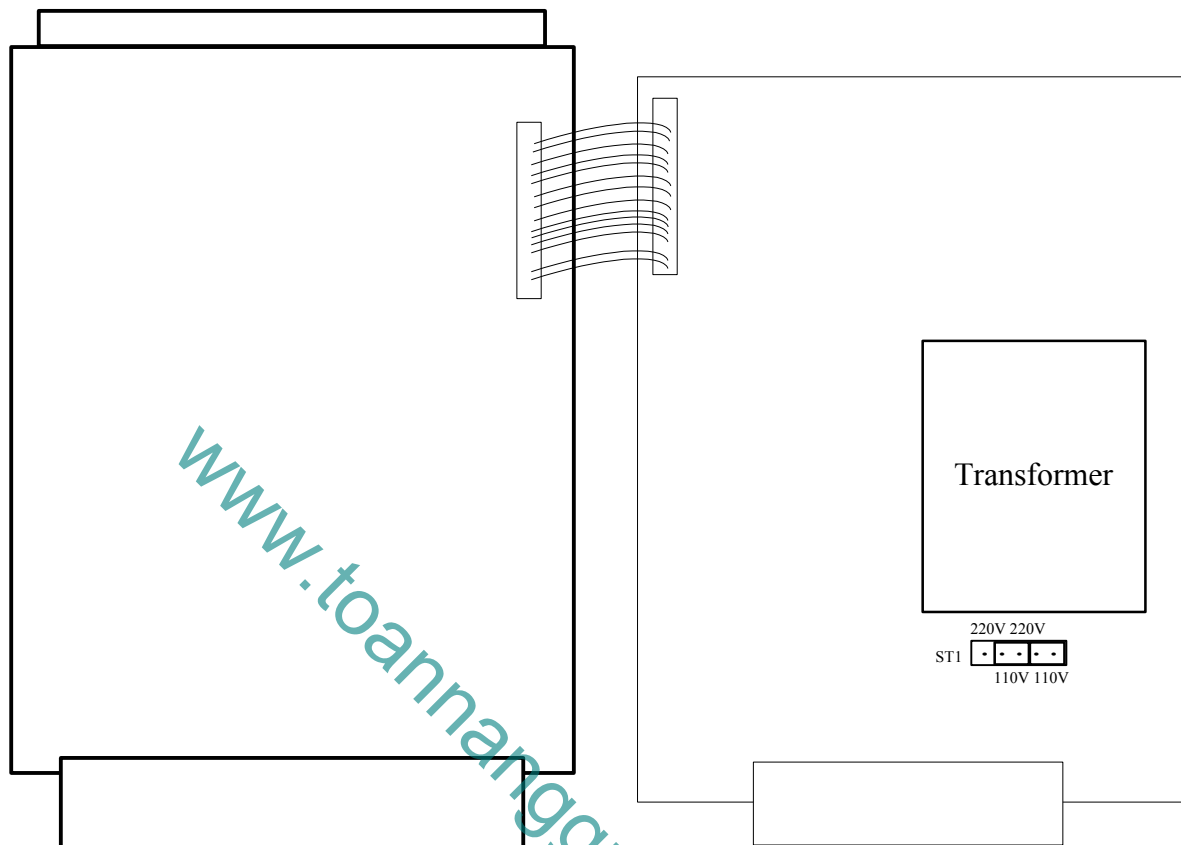

- **220V setting:**
ST1 should be in “220V” .
- **110V setting:**
ST1 should be in “110V” .

11-3 STANDARD ASCII CODE TABLE

Character	Heuristic code	Decimal code	Description	
^@	00	00	NUL	Null character
^A	01	01	SOH	Start of Header
^B	02	02	STX	Start of Text
^C	03	03	ETX	End of Text
^D	04	04	EOT	End of Transmission
^E	05	05	ENQ	Enquire
^F	06	06	ACK	Acknowledgement
^G	07	07	BEL	Bell
^H	08	08	BS	Backspace
^I	09	09	TAB	Tab characters
^J	0A	10	LF	Line Feed
^K	0B	11	VT	Vertical Tab
^L	0C	12	FF	Form Feed
^M	0D	13	CR	Carriage Return
^N	0E	14	SO	Shift Out
^O	0F	15	SI	Shift In
^P	10	16	DLE	Data Link Escape
^Q	11	17	DC1	Device Control 1 (X-ON)
^R	12	18	DC2	Device Control 2
^S	13	19	DC3	Device Control 3 (X-OFF)
^T	14	20	DC4	Device Control 4
^U	15	21	NAK	Negative Ack
^V	16	22	SYN	Synchronize
^W	17	23	ETB	End of Text Block
^X	18	24	CAN	Cancel
^Y	19	25	EM	End of Media
^Z	1A	26	SUB	Substitute
^[1B	27	ESC	Escape
^\ ^_	1C	28	FS	Form Separator
^]	1D	29	GS	Group Separator
^^	1E	30	RS	Record Separator
^_	1F	31	US	Unit Separator

11-4 PT650D FUNCTION LIST

Function			Customer's files
No.	Description	Default	
F0	(0)	Exit setting	F0 = 0
F1	(0 - 1)	Zero track time	F1 = 0 No track
F2	(0 - 2)	Zero track band	F2 = 1 2 step width
F3	(0 - 3)	Motion detection	F3 = 1 3 step width/sec
F4	(0 - 5)	Multiplier or decimal point	F4 = 1 Decimal point
F5	(0 - 2)	Division	F5 = 0 1 step width
F6	(0 - 21)	Max. capacity	F6 = 11 10000
F7	(0 - 3)	Baud rate	F7 = 2 9600 baud rate
F8	(0 - 1)	RS232/RS485 output mode	F8 = 1 Command mode
F9	(0 - 1)	Unit	F9 = 0 kg
F10	(0 - 9)	Zero return range	F10 = 3 4%
F11	(0 - 9)	Digital filter	F11 = 0 0
F12	(0 - 4)	Display update rate	F12 = 4 20 times/sec
F13	(0 - 7)	BCD output rate	F13 = 6 100 times/sec
F14	(00 - 99)	RS485 ID code	F14 = 01 01
F15	(0 - 6)	Peak hold	F15 = 0 No peak hold
F16	(0 - 8)	Input 1	F16 = 0 Function
F17	(0 - 8)	Input 2	F17 = 1 Zero return
F18	(0 - 8)	Input 3	F18 = 2 Tare
F19	(0 - 2)	Comparison condition	F19 = 0 Gross weight

www.toannanggroup.com.vn



Chi Mei Electronics Co., Ltd.

Flat D, 13/F, Por Mee Fty.Bldg.,

500 Castle Peak Road,

Lai Chi Kok, Kowloon, Hong Kong

Tel: (852)27444419

Fax: (852)27442060

E-mail: sales@chimei.com.hk

Homepage: <http://www.chimei.com.hk>