

DKX

Twin-Shaft Batch Mixer

The benchmark in mixing technology

BHS
SONTHOFEN

TRANSFORMING
MATERIALS
INTO VALUE



Headquarter of BHS-Sonthofen in Germany



TRANSFORMING MATERIALS INTO VALUE

BHS
SONTHOFEN



The company

BHS-Sonthofen is an owner-operated group of companies in the field of machinery and plant engineering based in Sonthofen, Germany. The company offers technical solutions for mechanical process technology, concentrating primarily on mixing, crushing, recycling and filtration. BHS-Sonthofen has a global presence with more than 400 employees and several subsidiaries.

Over 130 years of experience in mixing technology

BHS-Sonthofen invented the first twin-shaft batch mixer back in 1888 and has been systematically upgrading the design ever since. Today, BHS mixers are the benchmark in mixing technology. Thousands of BHS mixers are in operation throughout the world, providing reliable service day after day.

Mixing tests in the BHS test center

BHS offers customers the opportunity to run mixing tests with their own specific materials at the BHS test center in Sonthofen. Furthermore, laboratory mixers can also be operated directly at the customer's location to develop solutions to challenging problems.

Valued partner

We are a valued partner with many mixing plant manufacturers around the world.

Worldwide service

BHS offers quick and reliable service worldwide with its technical customer support and spare parts stock on three continents for all machine types, including older mixers.

www.bhs-sonthofen.com

BHS twin-shaft batch mixer

Twin-shaft mixing technology is suitable for all formulas and offers a wide range of benefits. The mixing technique has a significant effect on the quality of the mixture and the economic efficiency of the production process.

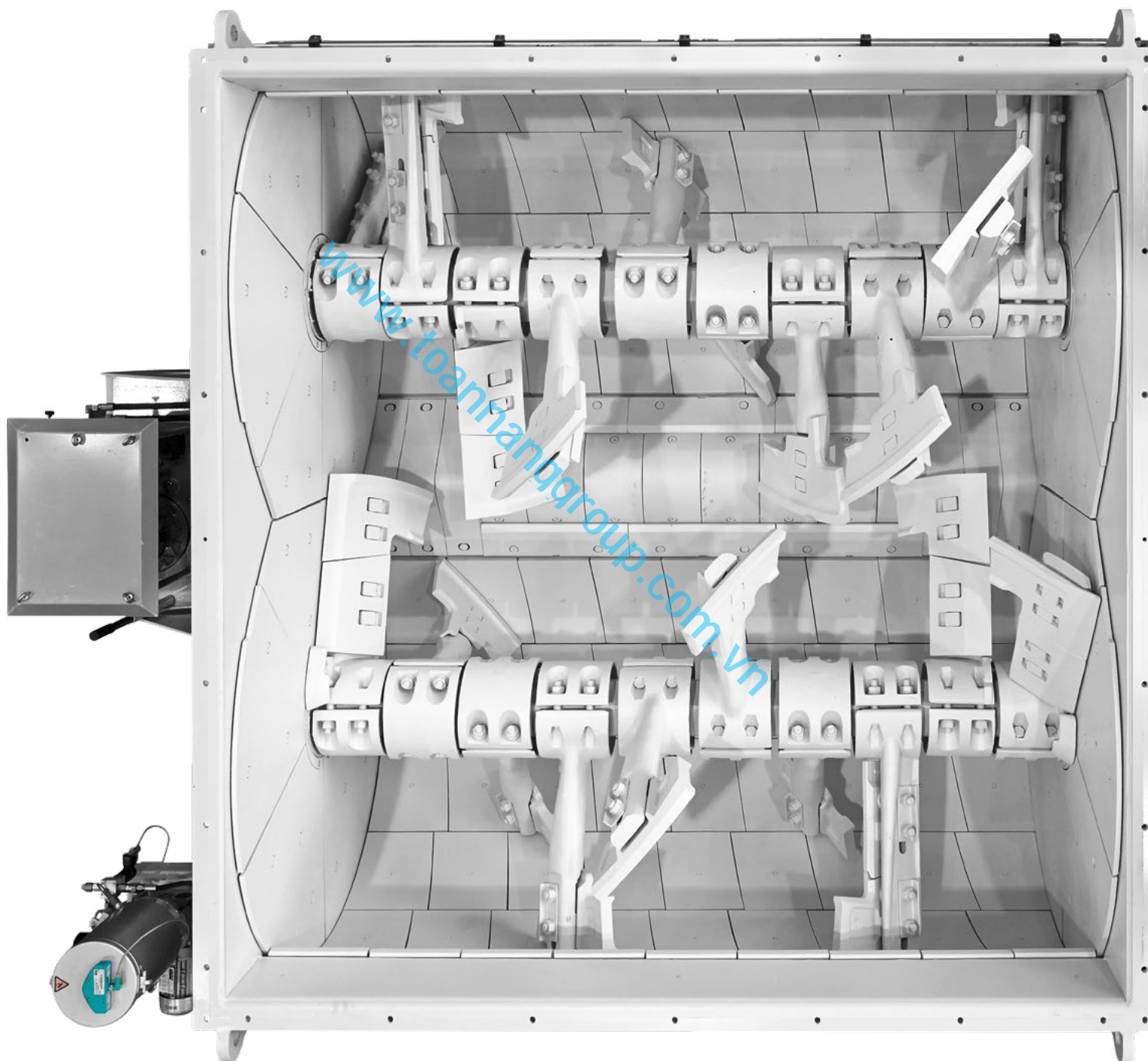

Consistent and reliable mixing results

Thanks to the proven design and arrangement of the mixing tools, you will achieve consistent homogeneous mixtures batch after batch in less time.

Maintenance-friendly and robust design

Our machines are characterized by a sturdy and durable design, providing safe and easy access for maintenance work.

Comprehensive modular system

We offer a broad spectrum of mixer sizes and accessories. The extensive modular system allows our twin-shaft batch mixer to be adapted precisely to your needs.



APPLICATION-ORIENTED MIXER CONFIGURATION

In addition to our standard configuration, we also offer numerous options for customizing your twin-shaft batch mixer to the individual application.

Drive power

Our twin-shaft batch mixer can be designed with different drive configurations to meet the maximum torque requirements.

Speed

In order to adapt the Froude number to the specific mixing task, the mixer can be operated with a different speed, a pole-changing motor or a variable-frequency drive.

Feeding sequence

The location of the inlets and the sequence of feeding the materials have an influence on the mixing results and the mixing time. We have the know-how to achieve optimal mixer charging.

Discharge

Depending on the application and plant requirements, various discharge gates are available for discharge of the mixer, including a split design and discharge door flaps.

www.toanhanggroup.com.vn

OUR BROAD RANGE OF DKX PRODUCTS

With the comprehensive range of twin-shaft batch mixers, BHS-Sonthofen can provide the best possible solution for many applications.

Basic machine configuration options

DKX: The powerhouse for maximum operational reliability

DKXS: The all-rounder

DKXN: The cost-effective solution for ready-mixed concrete

Additionally, depending on the individual requirements, mixers are available with versatile configuration options for the mixing tools, drives, discharge variants etc.

The twin-shaft batch mixers from BHS are available in sizes from 0.50 to 9.00 m³ and can be fitted with a range of options in accordance with the specific requirements. Our customers will benefit when working with our highly skilled specialists towards choosing the proper mixer for your application.

Application	DKX	DKXS	DKXN	DKXD	DKXG
Pumped concrete	✓	✓	✓		
Ready-mixed concrete	✓	✓	✓		
Ready-mixed concrete with input size up to 64 mm	✓	✓			
Shotcrete	✓	✓			✓
Wet mortar	✓	✓	✓		
Screed	✓	✓			
Precast concrete	✓	✓			✓
SCC	✓	✓			✓
Specialty concrete grades	✓				✓
Lean concrete	✓			✓	
Heavy concrete > 2.4 t/m ³	✓			✓	
Coarse-grained mixtures up to 160 mm, depending on machine size				✓	
Mixtures for concrete block production	✓				✓

ADVANTAGE OF THE THREE-DIMENSIONAL MIXING CONCEPT

Unlike the circular motion of other mixing systems, the three-dimensional mixing concept of the twin-shaft batch mixer results in a more intensive exchange of materials and thus in shorter mixing cycles with reduced energy consumption.

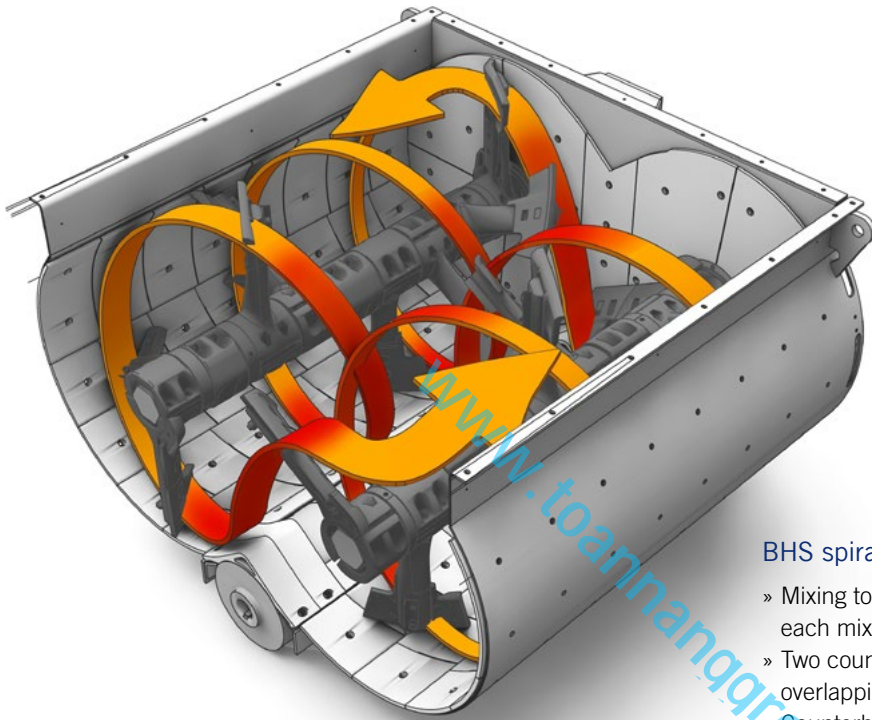

Functional principle: spiral mixing tools

BHS spiral mixing tools

- » Mixing tools arranged in the form of an interrupted spiral on each mixing shaft
- » Two counter-rotating mixing shafts with the mixing tools overlapping in the longitudinal center area of the mixer
- » Counterblades positioned at the ends of the shafts
- » Moderate circumferential speed of the mixing blades

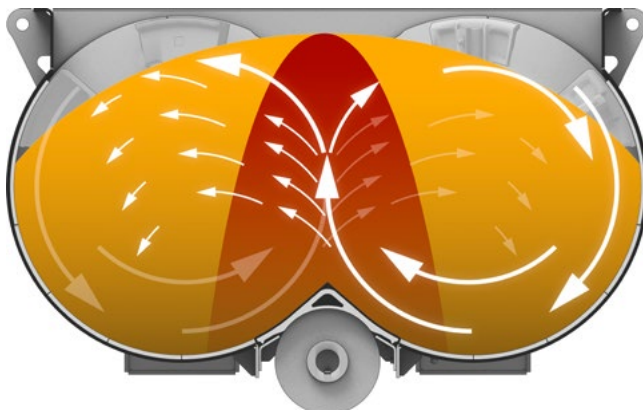

Functional principle: movement of the mixture

Mixing concept

- » Generation of a circular three-dimensional pattern for rapid mixture of batch ingredients
- » Intensive material exchange in the turbulent overlap area of the two mixing circles
- » Optimal conversion of the energy input into intensive relative movements of the mixture
- » Rapid movement of all materials throughout the mixer during the entire mixing process

RESULT

Quality and efficiency

Consistent high degree of mixture homogeneity with short mixing cycles

- » Rapid increase in uniformity of the mixture due to intensive material exchange
- » Constant consistency and homogeneity in each mixing cycle

Optimal energy efficiency

- » High mixing performance regardless of low rpm
- » Preservation of the grain structure of all batch ingredients
- » Low energy consumption due to short mixing cycles, optimized mixing tools and efficient drive system

Designed for low wear

- » Minimal wear of the mixing tools and mixing trough liner due to low rpm and compact design
- » Considerably less wear compared to pan or planetary mixers
- » Optimized design of all wear parts

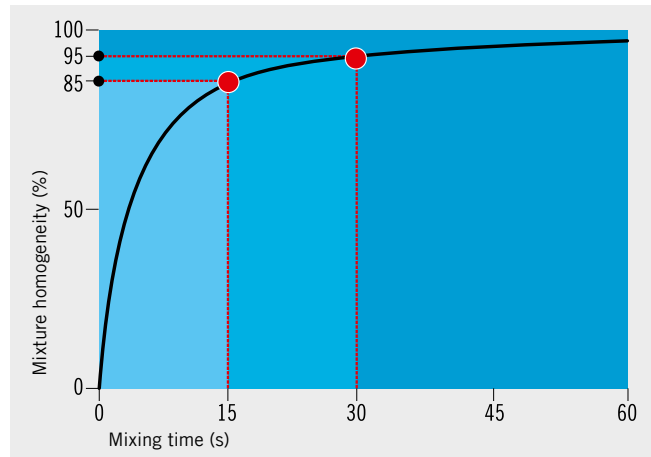

Development of mixture homogeneity over the mixing time for ready-mixed concrete

Efficient concrete production

- » Rapid, optimal suspension of cementitious materials
- » Potential for reducing the cement content
- » Uniform and fast distribution of admixtures and additives throughout the entire mixture
- » Small batches possible from 10% of nominal filling level
- » Future-proof design allowing for modern concrete formulas
- » Hybrid mixing cycles possible (slow – fast – slow)

Development of mixture homogeneity during the mixing process

The graphics use a realistic simulation to show the development of mixture homogeneity during the mixing process in a BHS twin-shaft batch mixer.

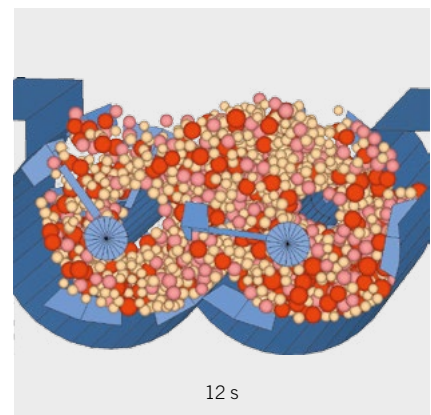
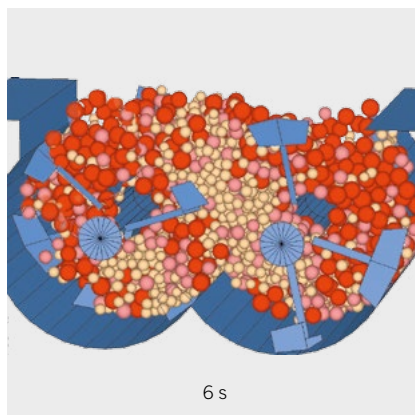
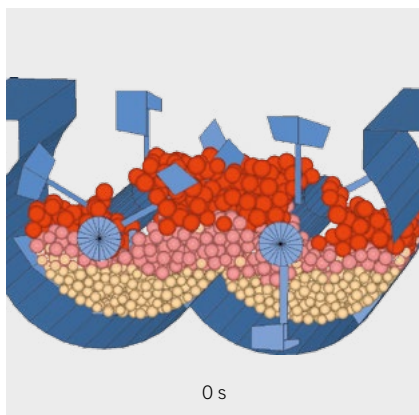

PROVEN DRIVE TECHNOLOGY

High operational reliability, energy efficiency and durability

Gearbox **1**

The BHS worm gearing offers maximum operational reliability and a long service life – even when exposed to extreme loads. The gearboxes are directly mounted on the mixing shafts without a rigid connection to the mixing trough. With the selected materials pairing, the BHS worm gearing compensates the load changes that occur every time the mixer is charged.

Electric motor **2**

We use only high-quality motors for our twin-shaft batch mixers. They are specially designed to withstand the load cycles encountered in mixing applications.

V-belt drive unit **3**

The drive power is transmitted by V-belt drives. They are located on the outer side of the drive units to ensure ready access for maintenance work.

Torque support **4**

The adjustable torque support is used for alignment of the gearboxes. It allows the gearboxes to be free from the mixing trough in order to avoid unnecessary loads on the gearing. This special feature is extremely important for achieving a long gearbox life.

Synchronous coupling **5**

A low-maintenance elastic coupling is installed between the gearboxes to synchronize the two mixing shafts.

Turbo coupling (optional) **6**

The hydrodynamic turbo coupling prevents both mechanical and electrical load peaks. It is recommended particularly in the case of unstable electricity supply conditions.

Shaft seals **7** and shaft bearings **8**

The mixing shafts are sealed with reliable axial face seals. The shaft bearings are mounted on bearing boxes and located separately from the shaft seals. This significantly increases operational reliability of the mixing shaft bearings.



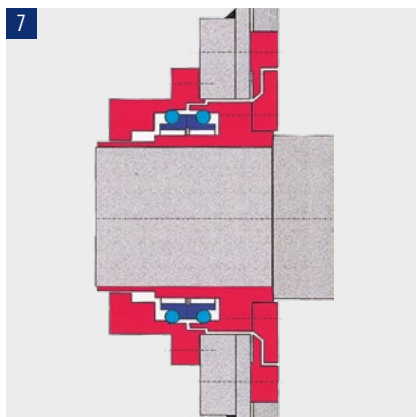
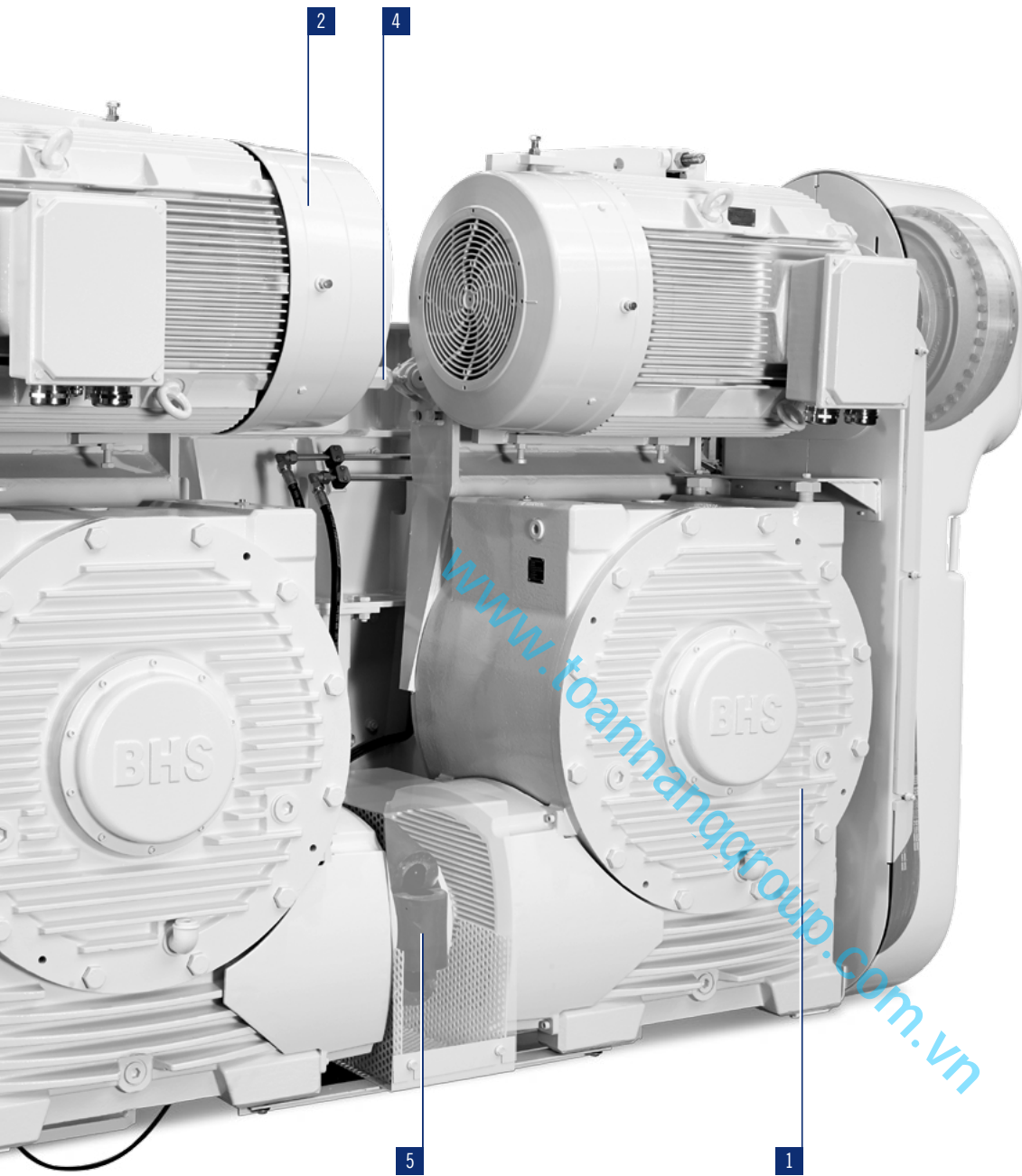

SPIRAL MIXING TOOLS

The basis for a homogeneous mixture

- » High-quality hexagonal shaft with high torsional and flexural strength
- » Streamlined mixing arms made of special cast steel
- » Spiral configuration of the mixing arms
- » Easily adjustable mixing blades

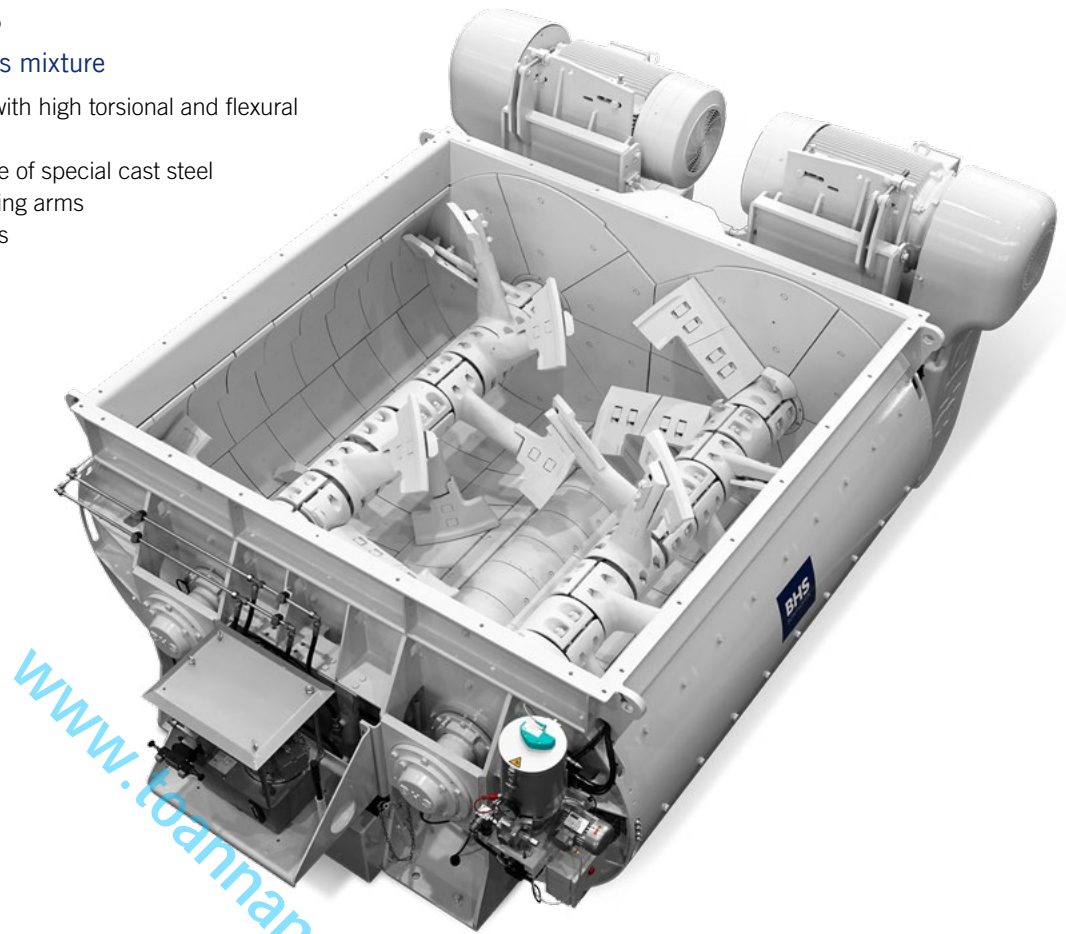

MIXING TOOLS

Suitable solutions for all mixture materials

Universal mixing tools 1

with 60° arm position for the production of ready-mixed concrete, precast concrete, specialty concrete grades and many other mixtures.

Smooth mixing tools 2

reduce adhesion to a minimum even when working with highly adhesive mixtures.

Coarse-grain mixing tools 3

for the production of concrete for hydro dam construction, suitable for aggregates up to 180 mm depending on the mixer size.

Duplex mixing tools 4

for the production of dry and moist mixtures with a high fine fraction. The duplex mixing arms significantly increase the number of relative motions in the mixture. This enables shorter mixing times.

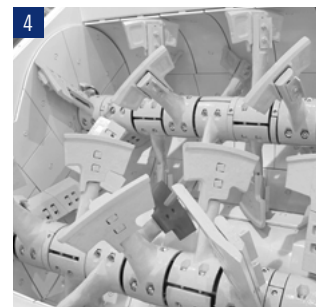

WEAR LINERS

Innovative solutions for a long service life

Rhombus tiles **1**

Rhombus-shaped tiles made of optimized cast chromium steel with a material thickness of 19 mm can be used to line the mixing trough. The service life can be increased by up to 30% compared to tiles of rectangular design.

OPTILONG tiles **2**

For applications subject to greater wear, we offer rhombus tiles with a material thickness of 28 mm. By varying the material hardness of the individual rows of tiles, uniform wear can be achieved across all the wear zones. The lifetime can be almost doubled compared to the standard rhombus tiles.

End wall liners

The end walls are lined with wear-resistant plates or optional optimized cast chromium plates.

MIXER DISCHARGE

Solutions and options tailored to requirements

Features of the discharge gate

- » Solid and robust cast iron design
- » Centrally located between the two mixing shafts
- » Effective sealing by means of adjustable gate ledges
- » Precise control of the discharge rate
- » Reliable operation using pneumatic or hydraulic cylinders

Discharge gate variants

- » Rotary gate **3** in standard size for most applications
- » Rotary gate in large-size version for accelerated discharge
- » Rotary gate **4** in split design for alternate discharge at two outlets

Discharge door flaps **5**

Discharge door flaps for residue-free discharge – typically for applications in the cement, dry mortar and waste disposal industries

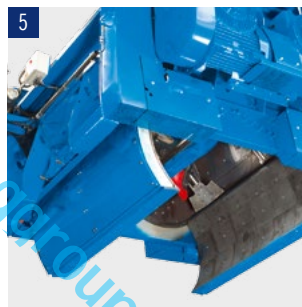
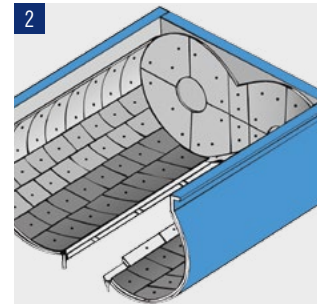

LUBRICATION SYSTEMS

For optimal and dependable lubricant supply

Central lubrication

The central lubrication system automatically supplies the inner mixing trough seals with grease during mixer operation. Manual lubrication is only required every time the mixer is cleaned.

Pulse-controlled central lubrication **1**

The pulse-controlled central lubrication system supplies the inner axial face seals with grease. After the mixer has been cleaned, or whenever required, lubrication of the seals can be triggered by pressing a button on the control unit; the lubrication time can be infinitely varied (Figure 1: Sample illustration).



Fully automatic central lubrication **2**

By PLC control, the lubrication points of the four inner mixing trough seals (optionally also the other lubrication points of the mixer) are automatically supplied with grease by means of progressive distributors. For lubrication after cleaning of the mixer, the grease pump can be operated by the PLC (Figure 2: Sample illustration).



www.toannangroup.com.vn

Moisture and temperature measurement ³

For measuring the moisture or temperature of the mixture, our twin-shaft batch mixers can be equipped with probes from any major manufacturer. Thanks to its design and also due to the intensive, three-dimensional movement of the mixture, the twin-shaft batch mixer delivers particularly reliable measurement results.

Sampling ⁴

Our twin-shaft batch mixers can be equipped with a device for taking mixture samples at the front end wall. This feature is a key advantage in the production of highly demanding concrete formulas.

Electrical terminal box ⁵

All the cabling can optionally be connected to a terminal box for easier installation.

Maintenance platform and maintenance step ⁶

Our twin-shaft batch mixers can be supplied with maintenance steps or mobile maintenance platforms to facilitate safe access for cleaning and maintenance work.

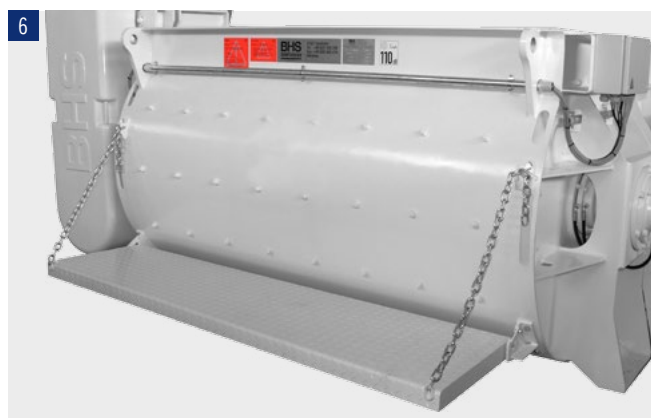

Mixing trough cover ¹

The dustproof mixing trough cover for our twin-shaft batch mixer is equipped with large maintenance hatches opened with the aid of gas springs. Optional custom connections for feeding, venting, video monitoring, or color and fiber addition are available upon request. Dust can be successfully captured by means of vent socks or an active filter (Figure 1: Sample illustration).

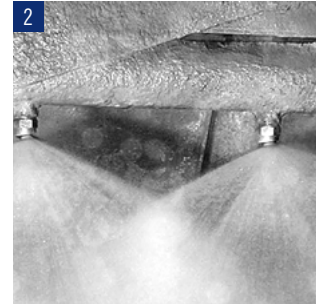

Water dosing ²

Depending on the requirements, water can be introduced via a baffle plate or spray pipe system (with or without pressure). The water nozzles of the pressurized spray pipe system are designed to handle pure or recycled water. Optional steam injection systems for the production of hot concrete are available upon request.

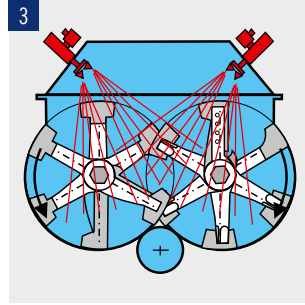

High-pressure cleaning ³

Our tried-and-tested high-pressure cleaning system with nozzle heads rotating in three dimensions is characterized by its excellent cleaning results and low water consumption. For cleaning the discharge hopper, the high-pressure cleaning system can be extended with an additional ring pipe system. In dual mixer plants, only one high-pressure system is required for cleaning the two mixers alternately.



Skip hoist ⁴

For fast and clean charging of the mixer with aggregates, we offer robust, custom-designed skip hoists. Tilting-skip or bottom-dump versions are available.

Discharge hopper ⁵

We supply both proven standard solutions and individual solutions for mixture discharge into truck mixers or open trucks. Illustration: discharge hopper in rubber basket version with hydraulically positioned drip guard, additional hopper for dumper loading, ring pipe system for cleaning, weight monitoring and inspection frame with telescopic struts.

Laboratory mixer ⁶

For your concrete laboratory, we can provide our twin-shaft batch mixer with a compacted concrete output of approximately 60 liters per batch. The complete mixer has been scaled down to enable meaningful test results that can be reproduced with the production machines.

Weighing system

We design and manufacture custom-tailored solutions specially for retrofit projects.

www.hoannangroup.com.vn

Combimix 7

Our patented Combimix system transforms the BHS twin-shaft batch mixer into a continuously operating mixer with proven twin-shaft mixing technology and controllable mixing time. The output can thus be boosted by up to 60% in comparison with batch mixing operation.

Vacuum mixer 8

Our twin-shaft batch mixer can be equipped for generation of a vacuum during the mixing process. This allows a particularly low air void content to be achieved in the mixture.

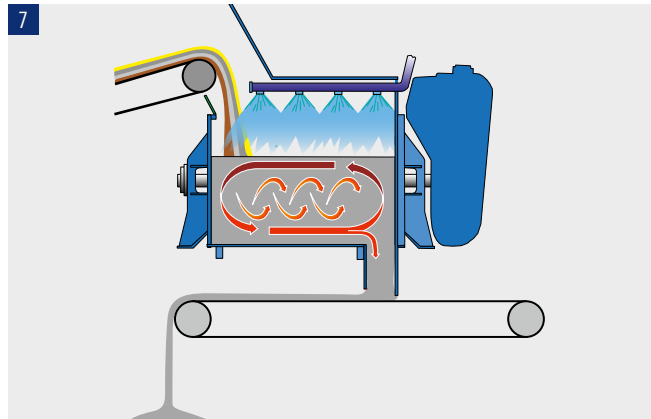

www.toannangroup.com.vn

Performance data (standard designs)

Type	Dry charge	Compacted concrete output per batch	Maximum compacted concrete output				Standard drive ³⁾	Maximum aggregate size	
			Truck mixer discharge ¹⁾		Open truck discharge ²⁾			Quality concrete	Hydro dam concrete ⁴⁾
DKX 0.50	0.75 m ³	0.5 m ³	73 cycles/h	37 m ³ /h	73 cycles/h	37 m ³ /h	15 kW	64 mm	–
DKX 0.75	1.13 m ³	0.75 m ³	65 cycles/h	49 m ³ /h	65 cycles/h	49 m ³ /h	22 kW	64 mm	–
DKX 1.00	1.5 m ³	1 m ³	58 cycles/h	58 m ³ /h	60 cycles/h	60 m ³ /h	37 kW	64 mm	80 mm
DKX 1.25	1.88 m ³	1.25 m ³	53 cycles/h	66 m ³ /h	53 cycles/h	66 m ³ /h	45 kW	64 mm	125 mm
DKX 1.67	2.51 m ³	1.67 m ³	48 cycles/h	80 m ³ /h	49 cycles/h	82 m ³ /h	55 kW	64 mm	125 mm
DKX 2.00	3 m ³	2 m ³	49 cycles/h	98 m ³ /h	53 cycles/h	106 m ³ /h	65 kW	64 mm	150 mm
DKX 2.25	3.38 m ³	2.25 m ³	46 cycles/h	104 m ³ /h	50 cycles/h	113 m ³ /h	65 kW	64 mm	150 mm
DKX 2.50	3.75 m ³	2.5 m ³	48 cycles/h	120 m ³ /h	56 cycles/h	140 m ³ /h	75 kW	64 mm	150 mm
DKX 2.75	4.13 m ³	2.75 m ³	46 cycles/h	127 m ³ /h	55 cycles/h	151 m ³ /h	2 x 45 kW	64 mm	150 mm
DKX 3.00	4.5 m ³	3 m ³	44 cycles/h	132 m ³ /h	53 cycles/h	159 m ³ /h	2 x 55 kW	64 mm	150 mm
DKX 3.33	5 m ³	3.33 m ³	41 cycles/h	137 m ³ /h	50 cycles/h	167 m ³ /h	2 x 65 kW	64 mm	150 mm
DKX 3.50	5.25 m ³	3.5 m ³	42 cycles/h	147 m ³ /h	52 cycles/h	182 m ³ /h	2 x 55 kW	64 mm	160 mm
DKX 4.00	6 m ³	4 m ³	39 cycles/h	156 m ³ /h	49 cycles/h	196 m ³ /h	2 x 65 kW	64 mm	160 mm
DKX 4.50	6.75 m ³	4.5 m ³	37 cycles/h	167 m ³ /h	51 cycles/h	230 m ³ /h	2 x 75 kW	64 mm	160 mm
DKX 5.00	7.5 m ³	5 m ³	35 cycles/h	175 m ³ /h	50 cycles/h	250 m ³ /h	2 x 90 kW	64 mm	160 mm
DKX 6.00	9 m ³	6 m ³	31 cycles/h	186 m ³ /h	48 cycles/h	288 m ³ /h	2 x 110 kW	64 mm	160 mm
DKX 7.00	10.5 m ³	7 m ³	28 cycles/h	196 m ³ /h	44 cycles/h	308 m ³ /h	4 x 75 kW	64 mm	160 mm
DKX 8.00	12 m ³	8 m ³	26 cycles/h	208 m ³ /h	43 cycles/h	344 m ³ /h	4 x 90 kW	64 mm	160 mm
DKX 9.00	13.5 m ³	9 m ³	24 cycles/h	216 m ³ /h	43 cycles/h	387 m ³ /h	4 x 110 kW	64 mm	180 mm

¹⁾ 30 s mixing time, truck mixer input rate of 0.12 m³/s (0.16 yd³/s) and compactability rate of 1.15.

²⁾ 30 s mixing time, compactability rate of 1.45.

³⁾ Alternative drive power available on request for other applications.

⁴⁾ For types DKX 1.00 to DKX 4.50 with coarse-grain mixing tools.

⁵⁾ Weight for standard design without accessories.

⁶⁾ 2,350 mm for DKX 3.00 in ISO variant.

Performance data for other materials available on request.

All specifications apply to the standard version.

Technical data for customized designs may differ from the specified data.

All technical data may change due to development.

Subject to modification without notice.

Dimensions and weights (standard designs)

A	B	C	D	E	F	Weight ⁵⁾
2,310 mm	1,275 mm	1,655 mm	1,550 mm	1,470 mm	1,000 mm	3,100 kg
2,540 mm	1,500 mm	1,880 mm	1,550 mm	1,470 mm	1,000 mm	3,600 kg
2,400 mm	1,230 mm	1,570 mm	2,040 mm	1,830 mm	1,200 mm	4,040 kg
2,590 mm	1,500 mm	1,840 mm	2,040 mm	1,885 mm	1,200 mm	5,200 kg
2,920 mm	1,765 mm	2,105 mm	2,040 mm	1,940 mm	1,200 mm	5,700 kg
2,590 mm	1,480 mm	1,900 mm	2,470 mm	2,040 mm	1,400 mm	7,500 kg
2,850 mm	1,740 mm	2,160 mm	2,470 mm	2,040 mm	1,400 mm	8,100 kg
3,100 mm	1,990 mm	2,410 mm	2,470 mm	2,070 mm	1,400 mm	9,000 kg
3,150 mm	1,990 mm	2,410 mm	2,470 mm	2,080 mm	1,400 mm	9,600 kg
3,410 mm	2,250 mm	2,670 mm	2,470 mm ⁵⁾	2,080 mm	1,400 mm	10,200 kg
3,410 mm	2,250 mm	2,670 mm	2,470 mm	2,110 mm	1,400 mm	10,400 kg
3,250 mm	1,995 mm	2,400 mm	2,855 mm	2,320 mm	1,650 mm	13,400 kg
3,500 mm	2,255 mm	2,660 mm	2,855 mm	2,320 mm	1,650 mm	14,000 kg
4,270 mm	2,510 mm	2,915 mm	2,855 mm	2,400 mm	1,650 mm	14,700 kg
4,260 mm	2,410 mm	2,870 mm	3,180 mm	2,760 mm	1,950 mm	22,000 kg
4,790 mm	2,940 mm	3,400 mm	3,180 mm	2,800 mm	1,950 mm	24,000 kg
5,290 mm	3,475 mm	3,935 mm	3,180 mm	2,590 mm	1,950 mm	29,000 kg
5,440 mm	3,475 mm	3,935 mm	3,180 mm	2,800 mm	1,950 mm	34,000 kg
5,980 mm	4,010 mm	4,470 mm	3,180 mm	2,800 mm	1,950 mm	37,000 kg

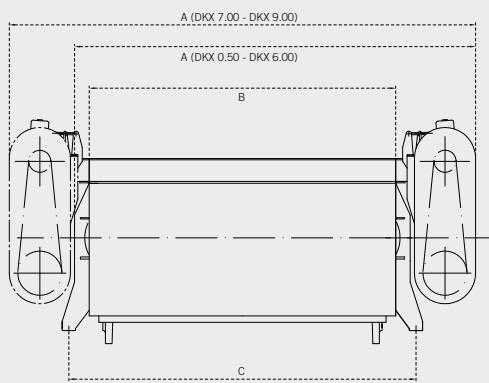

Type DKX 0.50 - DKX 9.00

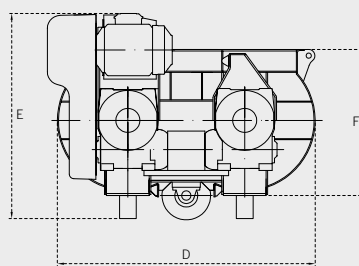

Type DKX 0.50 - DKX 2.50

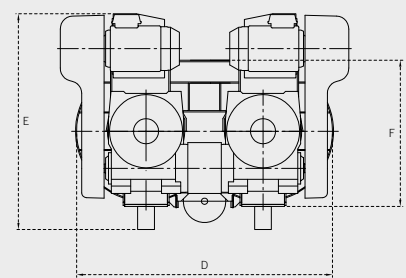

Type DKX 2.75 - DKX 9.00

BHS FIELDS OF COMPETENCE



MIXING
TECHNOLOGY



CRUSHING
TECHNOLOGY



RECYCLING
TECHNOLOGY



FILTRATION
TECHNOLOGY

