

FINISHED WALL / BACK SPLASH
完工墙面/防溅挡板

CENTERLINE OF FITTING
龙头安装孔中心线

>70 mm

Note: Before cutting countertop, allow handle clearance
注意: 在切割台面之前, 请留出安装水龙头的空间。

Note: Make sure enough faucet installation clearance.
Adjust the clearance between Faucet and Lav according to
Faucet's and customer's requirement.

注意: 预留足够的龙头安装空间,
根据实际选用的龙头和客户的需求
适当调整龙头与盆边缘的距离。

脸盆边缘
RIM OF LAVATORY

脸盆安装面边缘
RIM OF LAVATORY INSTALLATION FLAT

沿此线切割
CUT ALONG THIS LINE

KOHLER

K-4819T K-14022T-DB

时尚脸盆 VESSELS LAVATORY 切割图/安装说明书 CUT-OUT TEMPLATE / INSTALLATION INSTRUCTIONS

安装之前

注意: 本安装说明中展示的脸盆可能与您实际购买的产品不同。请放心, 其中的安装步骤仍可适用。

- 遵守当地所有给排水及建筑规定。
- 相关安装属专业性质, 故脸盆必须经由受过训练及有经验的技师进行安装。
- 切勿在本品上使用密封胶或有黏性的密封胶。
- 检查出水及供水管道, 如有需要便更换。
- 安装之前先开启新脸盆的包装, 检查有无损坏后放回纸箱中以免碰坏, 到准备安装时才取用。
- 如果可能, 在安装脸盆之前先组装脸盆上的龙头和排水管。
- 若为更换新脸盆, 须确保现有的柜台孔口与新脸盆的切割位相同或者较后者小。
- 科勒洗脸盆是根据美国标准制造的, 与美式洗脸盆配件相配。其它洗脸盆配件可能与之不相配。

所需的工具和物料 (不随货供应)

- 密封胶
 - 软性铅笔
 - 卷尺
 - 尖刀或剪刀
 - 匙孔线锯或手提电锯
 - 钻头(直径13毫米(1/2")或者更大的钻头)
 - 护眼镜
 - 锤子
 - 抹布或者纸质毛巾
- 注意: 若脸盆的物料并非木或木质合成品, 则您可能需要在安装脸盆时使用其他更专业的工具。

BEFORE YOU BEGIN

Note: The lavatory shown in this guide may differ from your actual product. The installation steps still apply.

- Observe all local plumbing and building codes.
- Due to the nature of the installation, the lavatories should be installed by trained and experienced installers.
- Do not use adhesives or adhesive sealants with this product.
- Inspect the waste and supply tubing; replace if necessary.
- Prior to installation, unpack the new lavatory and inspect it for damage. Return the lavatory to its protective carton until you are ready to install it.
- If possible, assemble the faucet and drain to the lavatory before installing the lavatory.
- For replacement installations, make sure the existing cutout is the same or smaller size as the new lavatory.
- Kohler lavatory is made according to American National Standard that it can match the American lavatory fittings. Any other lavatory fittings may not fit for Kohler lavatory.

TOOLS AND MATERIALS (Not Supplied)

- Sealant
 - Pencil
 - Tape measure
 - Sharp knife or scissors
 - Keyhole or saber saw
 - Drill (13mm(1/2") dia. drill bit or larger)
 - Safety glasses
 - Hammer
 - Rags or paper toweling
- NOTE: You may require different, more specialized tools to install this lavatory to countertop materials other than wood or wood composites.

尺寸图

Reference Value
参考值 UNIT: mm
单位: 毫米

	Length 长	Width 宽	Height 高	Depth 盆深
Outer 外径	550	375	180	
Inner 内径				130

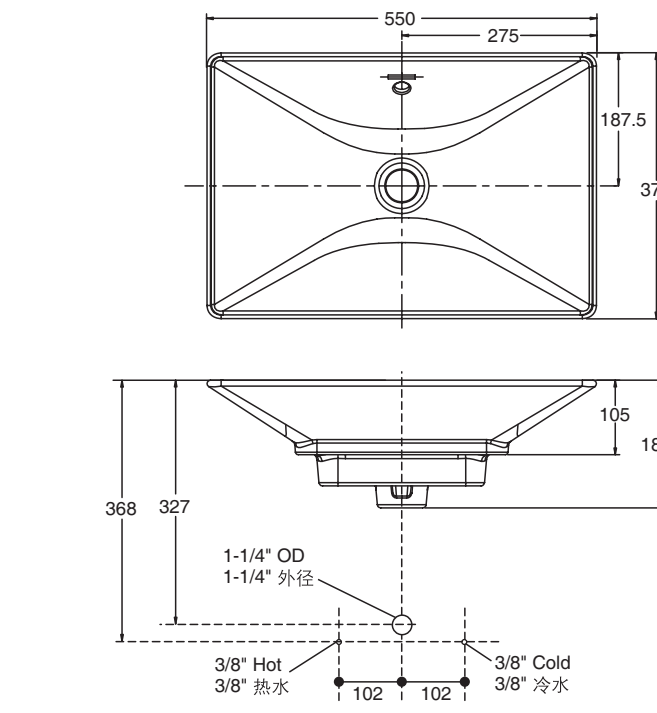

科勒公司保留随时变更图中标示尺寸的权利, 无需另行通知。
Kohler reserves the right to change marked dimensions without prior notice.

270mm

375mm

228mm

208mm

550mm

1168991-T01-B

© 版权为科勒中国有限公司所有, 2011
© Copyright Kohler China Ltd., 2011

拆除旧脸盆

- 关掉水龙头的供水源。
- 打开龙头阀门, 然后断开供水管。
- 再旋开排水装置, 并拿开弯管。
- 移走旧脸盆。

安装新脸盆

- 将切割图沿切割线切出。
- 将切割图放在盥洗台上, 确保脸盆、水龙头和防溅挡板之间有足够距离。
- 查核盥洗台下的储物柜也有足够空间。

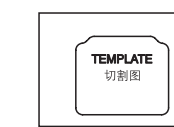

- 用炭笔沿切割图在盥洗台面划线。
- 再次检查脸盆、水龙头、防溅水板及储物柜的空间及距离, 如有需要可调整切割图的位置。

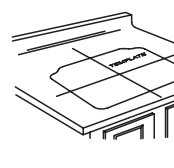

- 用一个13mm的钻头, 在切割口内侧钻一个导孔。
- 沿着自切割图勾划出来的铅笔线内侧切开台面。
- 暂将脸盆放入台面开口, 校正位置。

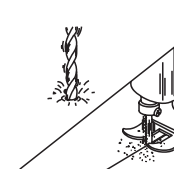

小心: 提防身体受伤或损坏产品, 因大型脸盆相当重, 需找人帮您一起搬动及安放。



- 用炭笔沿脸盆安装面外缘在盥洗台上划线。
- 然后将脸盆移开。
- 按照制造商的指引, 安装水龙头和排水管道。

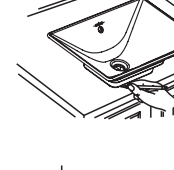

- 沿炭笔导线内侧涂两滴密封胶。
- 注意: 如果脸盆已随附密封胶, 请勿使用其它密封胶。
- 用涂油灰刀将其抹匀。

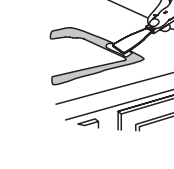

- 小心地将脸盆置于台面切口适当位置, 向下按牢。
- 小心: 提防身体受伤或损坏产品, 因大型脸盆相当重, 需找人帮您一起搬动及安放。

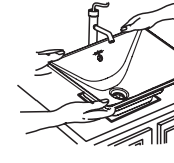

- 立即擦去多余的密封胶, 如脸盆外缘与台面间有缝隙, 即用胶填满。
- 检查脸盆的位置准确。

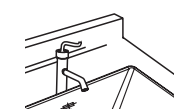

- 最少待三十分钟, 让密封胶干透后, 方可继续进行安装。
- 连接水龙头供水管。
- 连接排水装置。
- 开启水龙头阀门, 检查有无渗漏。
- 用非腐蚀性清洁剂来清洁。

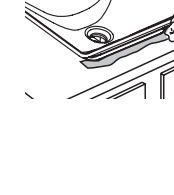

用户须知 (护理和清洁)

为保持脸盆光洁如新, 须确保每次使用后彻底冲洗干净, 切勿使用腐蚀性的清洁剂, 以免刮花及破坏脸盆的表面。要清除顽固污垢, 油漆或柏油, 可使用松油或油漆稀释剂。

不要在0°C以下的水环境中使用。

警告: 请勿使用钢丝球等硬质材料擦洗产品表面, 特别是产品商标处。

维修零件

REMOVE EXISTING LAVATORY

- Turn off the water supply to the faucet.
- Open the faucet valves, then disconnect the supply lines.
- Disconnect the drain assembly and remove the trap.
- Remove the existing lavatory.

INSTALL NEW LAVATORY

- Cut the template on the cutout line.
- Position the template on the countertop to ensure clearance between the lavatory, faucet, and backsplash.
- Verify cabinet clearance beneath the countertop.

- Trace the template on the countertop with a pencil.
- Re-check the clearance between the lavatory, faucet, backsplash, and cabinet. Adjust the template accordingly.

- Drill a 13mm hole on the inside of the cutout opening.
- Cut the opening in the countertop along the inside edge of the pencil line.
- Temporarily position the lavatory in the opening, and adjust to fit.

CAUTION: Risk of personal injury or product damage. Large lavatories are very heavy. Get help lifting the lavatory into place.

- Trace a pencil line around the rim of lavatory installation flat.
- Remove the lavatory.
- Install the faucet and drain according to the manufacturers instructions.

- Apply two beads of sealant to the inside of the pencil line.
- NOTE: Do not substitute another sealant if one is supplied with this lavatory.
- Spread the sealant evenly with a putty knife.

- Carefully position the lavatory in the cutout, and press down firmly.
- CAUTION: Risk of personal injury or product damage. Large lavatories are very heavy. Get help lifting the lavatory into place.

- Immediately wipe away any excess sealant, and fill any voids as needed.
- Verify that the lavatory has not moved out of position.
- Allow the sealant to cure for at least 30 minutes before proceeding.
- Connect the faucet supply lines.
- Connect the drain assembly.
- Open the faucet valves, and check for leakage.
- Clean up with a non-abrasive cleaner.

IMPORTANT CONSUMER INFORMATION (CARE AND CLEANING)

To keep your lavatory looking new, make sure you rinse it out thoroughly after each use. DO NOT USE ABRASIVES on this product, as they will scratch and ruin the surface. Stubborn stains, paint, or tar can be removed with turpentine or paint thinner.

Do not use the product in the water below 0°C.

CAUTION: Please do not use hard materials (like scouring pad) to clean product surface, especially the product logo.

SERVICE PARTS

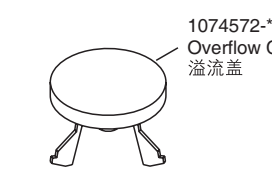

订购时请说明颜色代码(-)或表面处理(**)
Color code (-) or finish (**) must be specified when ordering.