

# Installation Guide

## 安装说明

C<sup>3</sup> Toilet Seat with Bidet Functionality

C<sup>3</sup> 清舒宝智能座便盖

K-4736T

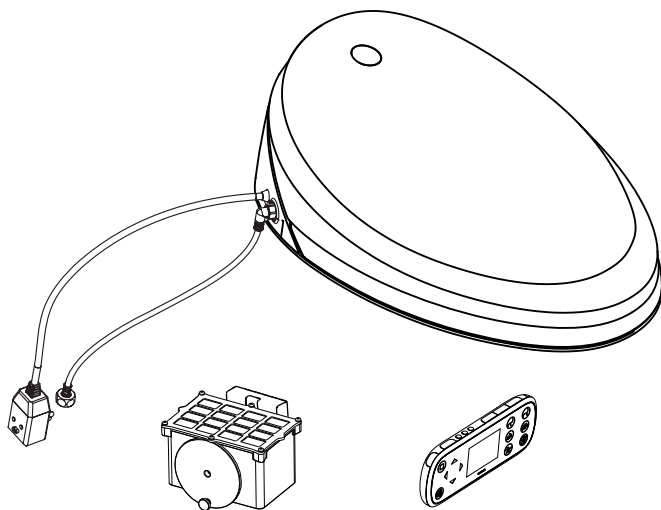

上海科勒电子科技有限公司  
上海市浦东新区金滇路18号E幢 邮编: 201206

## Thank You For Choosing Kohler Company

We appreciate your commitment to Kohler quality. Please take a few minutes to review this manual before you start installation. If you encounter any installation or performance problems, please don't hesitate to contact us. Thanks again for choosing Kohler Company.

## Tools and Materials



Adjustable  
Wrench

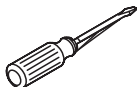

Blade Screwdriver



Masonry Drill



Screw drivers

## Before You Begin



**WARNING: Risk of electric shock, fire, or personal injury.**

This product must be grounded. Connect only to a dedicated 220-240VAC, 50/60 Hz, 16A circuit protected by Ground-Fault Circuit-Interrupter (GFCI) or Earth-Leakage Circuit-Breaker (ELCB).



**WARNING: Risk of electric shock or product damage.** Do not immerse or flush the product with water.

**IMPORTANT! Risk of product damage.** Do not plug in the seat until all other installation steps have been completed.

**IMPORTANT! Risk of product damage.** Do not install this seat in a location where water might be splashed on the product.

**IMPORTANT! Risk of product damage.** Do not install this seat in a location exposed to excessive moisture where condensation might form on the product surface. Please ensure sufficient ventilation in your surroundings to prevent possible damage to electronic components.

## Before You Begin (cont.)

**IMPORTANT! Risk of product or property damage.** Pushing or pulling on the water connection may cause water leakage.

**IMPORTANT! Risk of product damage.** Do not apply excessive force to the spray wands. Product may break.

**IMPORTANT! Risk of product damage.**

Take care to face right in position to the thread while connecting seat inlet pipe, otherwise, the inlet pipe thread may wear off and lead to water leakage.

- Observe all local plumbing and building codes.
- All information in these instructions is based on the latest product information available at the time of publication. Kohler Co. reserves the right to make changes at any time without notice.
- Do not use an extension cord with the product.
- Connect to a cold water supply with a pressure of 0.7~7.5kgf/cm<sup>2</sup> (0.07~0.74MPa).
- Connect only to a cold water supply line carrying direct tap water.
- Unplug the seat and drain the seat if the functions of the seat will not be operated for an extended period of time.

## 1. Match toilet roughing-in requirement and installation tips

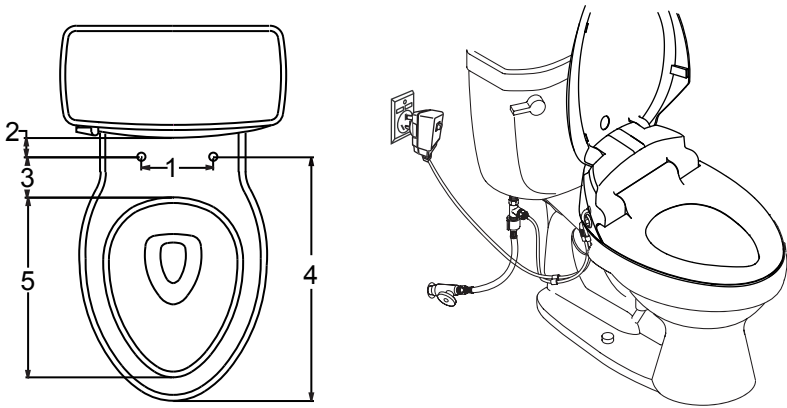

- 1 Distance between installation holes: 136-140mm
- 2 Distance between installation holes and tank front rim: >20mm
- 3 Distance between installation holes and bowl inner rim: <70mm
- 4 Distance between installation holes and tank top rim: 460-490mm
- 5 Bowl inner diameter: 370-390mm
- 6 Reserve place around 1 meter away from the toilet before installation

## 2. Install an Electrical Outlet



### **WARNING: Risk of electric shock, fire, or personal injury.**

This product must be grounded. Connect only to a dedicated 220-240 VAC, 50/60 Hz, 16A circuit protected by Ground-Fault Circuit-Interrupter (GFCI) or Earth-Leakage Circuit-Breaker (ELCB).

- It is recommended to use water-resistant socket. Do not use an extension cord with the product.

**NOTE:** Follow local codes when determining the electrical outlet location.

- Route the electrical and install to a 220-240 V GFCI- or ELCB-protected receptacle.

## 3. Preparation

- Remove the existing toilet seat. Turn off the water supply to the toilet.
- Flush the toilet to relieve any pressure from the water supply hoses.
- Position a container under the fill valve to catch any excess water.
- Disconnect the water supply hose from the toilet fill valve.
- Ensure that there are no obstacles within 40cm in front of the toilet.

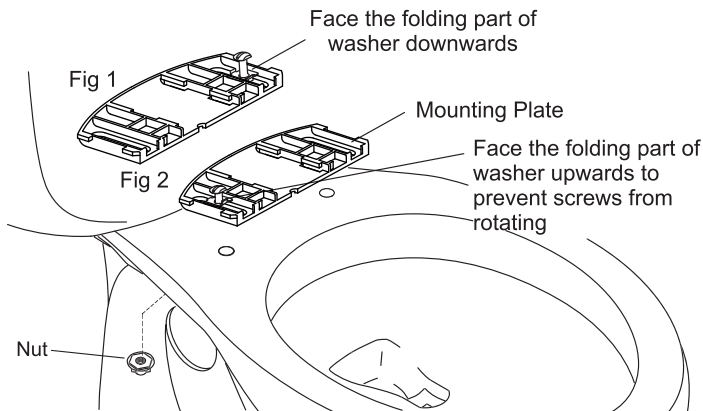

#### 4. Install the Mounting Plate

- Position the mounting plate over the toilet mounting holes.
- Slide a washer onto each of the bolts.

**NOTE:** Some toilets come with threaded inserts pre-installed in the mounting holes. For toilets with threaded inserts, the nut is not required.

##### **For Toilets with Threaded Inserts (Fig 1):**

- Insert a bolt through the mounting plate and position the washers so they rest in the grooves of the mounting plates. Please pay attention to washer direction.
- Loosely thread the bolts into the inserts. Do not overtighten for future adjustment.

##### **For All Other Installations (Fig 2):**

- Position the mounting plate over the toilet mounting holes.
- Slide a washer onto each of the bolts. Please pay attention to washer direction.
- Insert a bolt through the mounting plate and the toilet mounting holes.
- Position the washers so they rest in the grooves of the mounting plate.
- Thread a nut onto each of the bolts. Handtighten the nut.

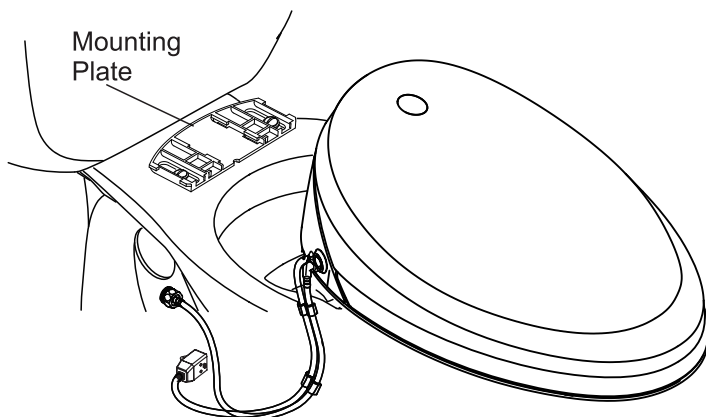

## 5. Install the Seat

- Align the slot on the mounting plate with the groove located below the toilet seal, slide the seat onto the mounting plate until you feel it snap into place.

**NOTE:** The mounting plate may need to be adjusted to properly align the seat.

### For Toilets with Threaded Inserts:

- To adjust the seat position, remove the seat (see Homeowners Guide) and reposition the mounting plate as needed.
- Reinstall the seat. Repeat the adjustment procedure as needed until seat is properly aligned.
- Once the seat is positioned as desired, remove the seat and securely tighten down the mounting plate.
- Reinstall the seat.

### For All Other Installations:

- No need to remove the seat for seat position adjustment, as show in Fig 2. Adjust the position seat and mounting plate only by loosening nuts and tighten nuts when they are adjusted to properly align the seat. No worry screws will follow the turning.

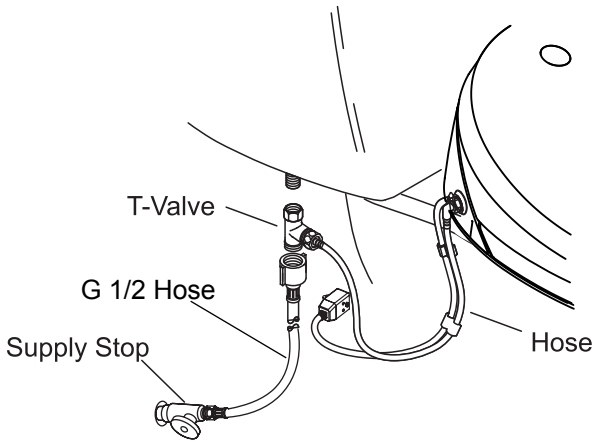

## 6. Connect the Water Supply

**IMPORTANT! Risk of product damage.** Take care to face right in position to the inlet pipe thread and seat thread. Take care not to crossthread or overtighten connections. Hand tighten plus one-quarter turn is sufficient for tightening.

**IMPORTANT! Risk of product damage.** Use care not to scratch the product surfaces.

- Connect the T-valve directly to the toilet fill valve.  
**NOTE!** For those newly installed G 1/2 hose, before the inlet hose connected to T-valve, must flush for several seconds to clean the inner side of the pipe, in order to remove the dirt and debris etc.
- Connect the T-valve to the toilet seat with the supplied hose.
- Connect the water supply to the T-valve.
- Turn on the water supply.
- Check all connections for leaks and make any adjustments as needed.

Installation Step:

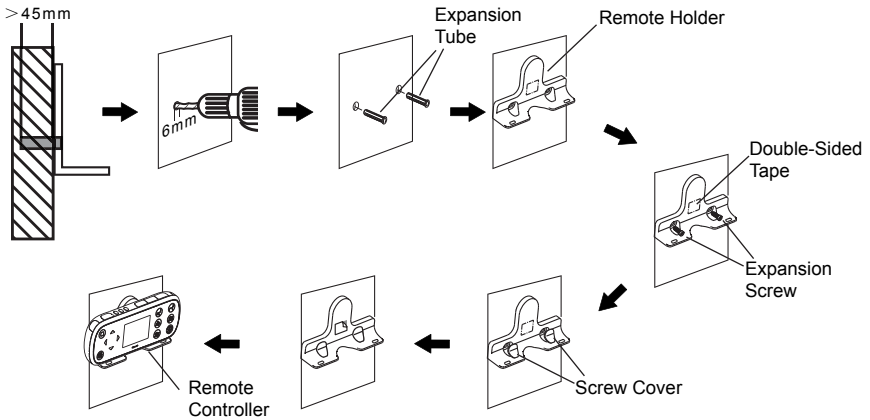

## 7. Installation of Remote Controller Holder

- Choose a mounting location for the remote holder that is easily accessible while sitting on the seat.
- Drilling two holes with depth larger than 45mm on the wall by drill with a diameter of 6mm in accordance with the position of screw holes on the remote control holder. Installing the expansion tube into the holes.
- Placing the installation holder on the fixing hole.
- Peeling off the release paper of double-sided tape at the back of holder.
- Fixing the holder with screws and install it.
- Installing the screw covers on the screws.
- Placing the remote controller on the holder.

**NOTE:** if the wall for installation is made of special material (such as wood board, density board and etc.), suitable fixing methods shall be adopted.





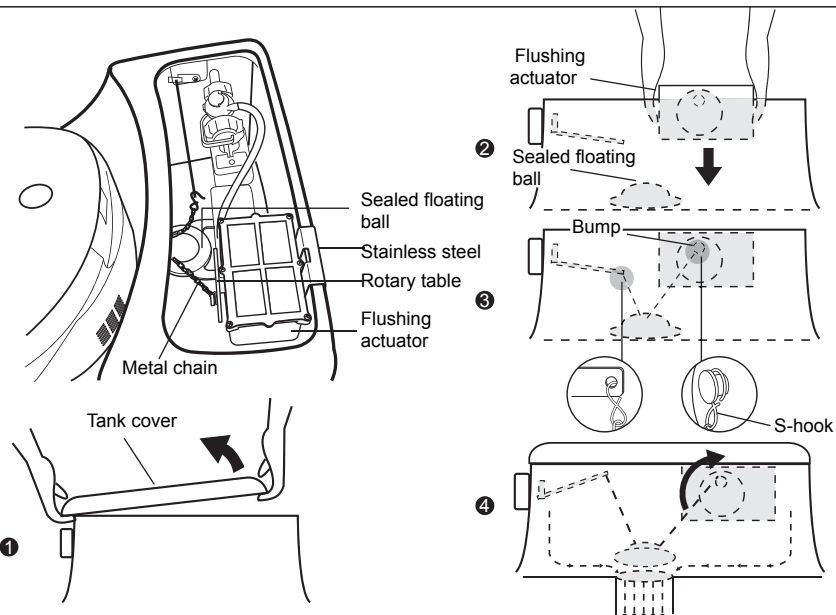

## 8. Installation of flushing actuator

- Remove the tank cover.
- Place flushing actuator above the sealed floating ball in the tank.  
**NOTE:** When installing the flushing actuator, you can adjust the position of stainless steel so as to fit the tank cover properly.
- Connect the salient point of the rotary table on "flushing actuator" and the hang clasper on the "sealed floating ball" with "metal chain".  
**NOTE:** 1. Buckling and hanging points on the "sealed floating ball" shall be near to the floating ball.  
 2. Twining on the primary manually lifting and pulling metal strip is not allowed.  
 3. When installing the metal chain, you need to adjust the length of the chain tailored to tank mechanism (Adjust S-hook to the proper position in the chain, ensuring the chain is fully stretched and locked straight by S-hook).
- Rotate the auto flush dial manually. Ensure the dial can lift up the sealing float completed in the rotation to achieve best flushing effect.
- Press  key to double confirm the flushing mechanism works smoothly.
- Cover the tank cover properly.

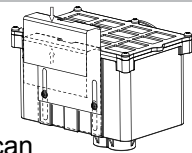

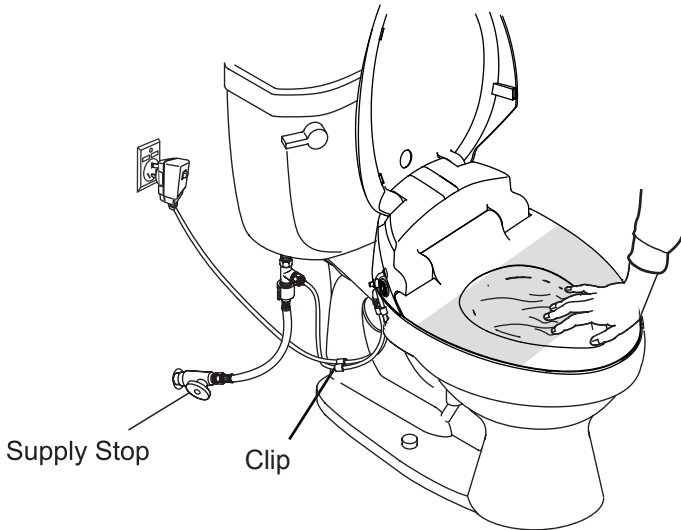

## 9. Installation Checkout

- Wrap the toilet seat with plastic wrap to prevent water from spraying from the toilet during testing.
- Plug in the power cord and press the power button.
- Verify the auto cover turning and flushing functions (refer to the homeowner's guide).
- Place one piece of dampened cloth or wet tissue in the seat inductive area to imitate the status of seat taking; Verify the function of flushing (refer to the homeowner's guide).
- Make sure to take away the cloth or tissue in the seat inductive area after normality confirmation.

## 感谢您选择科勒公司

我们感谢您对科勒质量的信任。在您开始安装前，请您花几分钟时间阅读这本手册。如果您在安装或性能方面遇到任何问题，务必请您与我们联系。再次感谢您选择科勒公司。

## 工具和材料

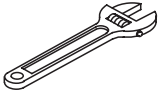

可调节扳手



一字螺丝刀



电钻

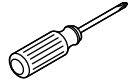

十字螺丝刀

## 安装之前



**警告：触电，火灾，或人身伤害的危险。**本产品必须接地良好。只能连接到专用的220-240V, 50/60Hz, 16A的带接地故障断路器或接地漏电保护器的电路中。



**警告：触电或产品损伤的危险。**不要把产品浸没在水中。

**重要！产品损伤的危险。**在所有其他安装步骤结束之前不要插电源线插头。

**重要！产品损伤的危险。**不要把产品安装在水可能溅到的地方。

**重要！产品损伤的危险。**不要把产品安装在过分潮湿的地方，在这种地方，水汽可能凝聚在产品表面。请始终保持使用环境有足够的通风，以防止电子组件的损坏。

**重要！产品损坏或财产损失的危险。**硬推硬拉水管接口可能造成水的渗漏。

**重要！产品损坏的危险。**不要在喷嘴上施加过大的力，否则产品可能损坏。

**重要！产品损坏的危险。**连接本产品进水管时要小心对正螺纹，否则会损坏产品进水口螺纹，造成漏水。

- 遵守所有当地的管道和建筑标准。
- 这本说明中所有的信息基于最新公开的产品信息。科勒公司保留在任何时间不通知的情况下做改变的权利。
- 不要使用延长电线连接产品。
- 连接到水压在 $0.7\text{kgf/cm}^2 \sim 7.5\text{kgf/cm}^2$  ( $0.07\text{MPa} \sim 0.74\text{MPa}$ )的冷水源。
- 只能连接到自来水的水源。
- 如果座圈长时间不用，请拔下插头并排干本机内的积水。

## 1. 适配座便盖尺寸要求及安装小贴士

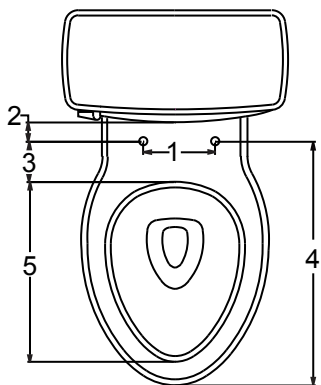

- 1 安装孔的间距: 136-140mm
- 2 安装孔与水箱的距离:  $>20\text{mm}$
- 3 安装孔与座便器内圈的距离:  $<70\text{mm}$
- 4 安装孔到座便器顶端的距离: 460-490mm
- 5 座便器内径尺寸: 370-390mm

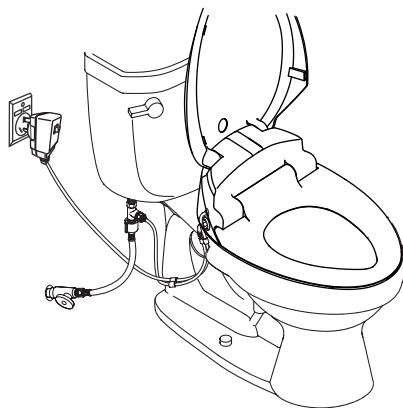

- 6 安装前请在座便器左侧约1米范围内预留电源插座

## 2. 安装电路出口



**警告:** 触电, 火灾或人身伤害的危险。本产品必须良好接地。只能连接到专用的220-240V, 50/60Hz, 16A带接地故障断路器或接地漏电保护器的电路中。

- 建议使用防水型插座, 不要使用延长电线连接产品。

**注意:** 在决定电路出口位置时, 要按照当地的标准。

- 连接到220-240V并带有接地故障断路器和接地漏电保护器保护的电路中。

## 3. 准备

- 移除现有的座圈。关闭座便器的供水系统。
- 冲洗座便器, 释放来自供水管的压力。
- 在进水阀下方放置一个容器装多余的水。
- 断开座便器进水阀与供水管的连接。
- 确保座便器前端40cm内无障碍物。

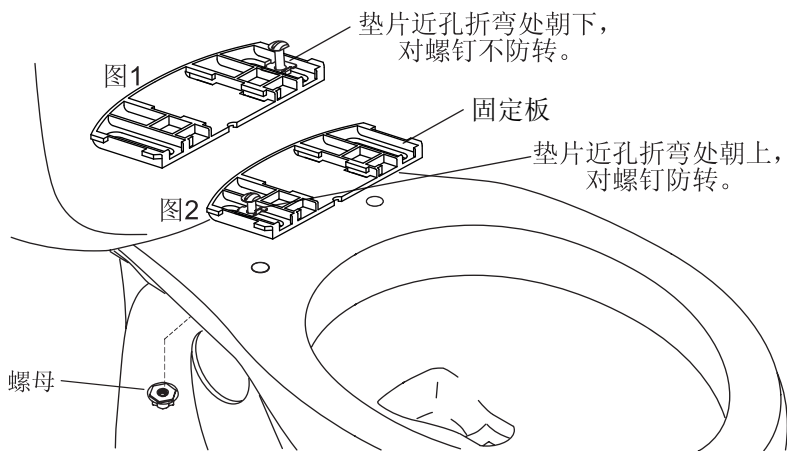

## 4. 安装固定板

- 在座便器安装孔上方放置固定板。
- 把螺丝分别插入垫圈内。

**注意：**一些座便器的底板孔内已经有螺丝。这种座便器不需要螺母。

**对有螺纹孔的座便器(安装如图1所示)：**

- 把螺丝插入固定板和座便器安装孔内，移动垫圈，使之卡在固定板的凹槽内，注意垫片方向：垫片近孔折弯处向下。
- 顺着螺纹轻轻地拧紧螺丝，不要拧得过紧，以便调整。

**对其他座便器(安装如图2所示)：**

- 在座便器安装孔上方放置固定板。
- 把每个螺丝分别插入垫圈内，注意垫片方向：垫片近孔折弯处向上。
- 把螺丝插入固定板和座便器的安装孔内。
- 移动垫圈，使之置于固定板的凹槽内。
- 在每个螺丝上拧上螺母，用手拧紧螺母。

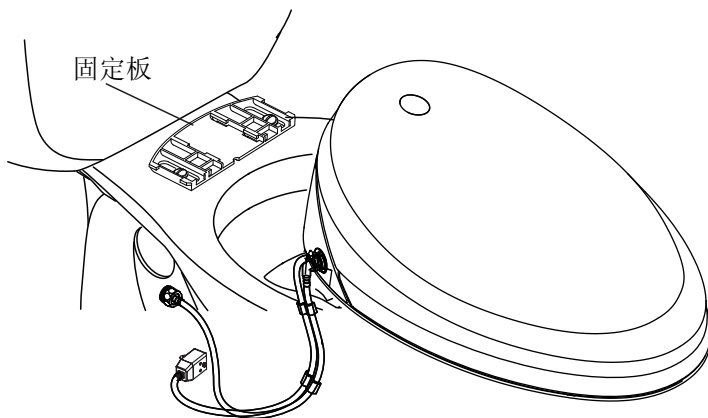

## 5. 安装座便盖

- 对正座便盖底部和固定板之间的卡槽，让座便盖在座便器陶瓷面上沿向水箱方向推动，当听到咔嚓声说明安装完成。

**注意：**固定板可能需要调节具体位置，从而保证座圈与陶瓷面之间很好配合。

### 对有螺纹孔的座便器：

- 要调节座圈位置，如有必要可以移除座圈(见用户手册)，重新调节固定板的位置。
- 重新安装座圈。如有必要重复调节的步骤直到座圈安装恰当。
- 一旦座圈位置确定，移除座圈，牢固的拧紧固定板。
- 重新安装座圈。

### 对其它座便器：

- 要调节座圈位置，不需移除座圈，如图2所示，只需拧松螺母，即可摆动调节座圈及固定板的位置，当位置适当，直接拧紧螺母即可，不必担心螺钉会跟转。

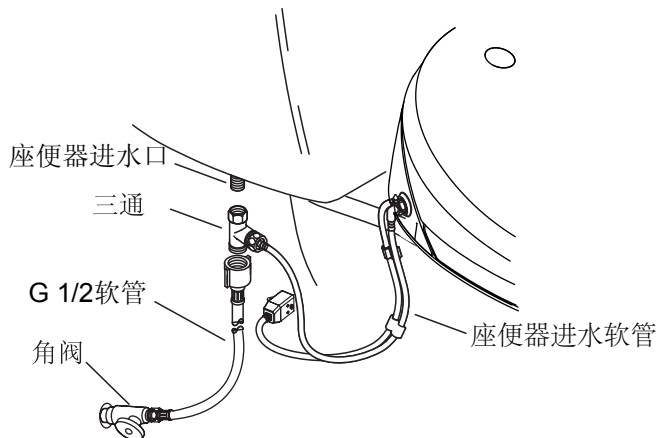

## 6. 连接供水系统

**重要！产品损坏的危险。**小心对准进水管与座便盖进水口的螺纹，不要破坏螺纹或过于拧紧接头。为了牢固的拧紧接头，用手拧紧后用工具再拧紧1/4圈。

**重要！产品损坏的危险。**小心不要刮伤产品表面。

- 直接将三通与座便器进水管口相连。

**注意！**对新安装的管路系统，在将G 1/2软管连接至三通以前，须直接排水数秒，以清除管道内沙石、污垢等。

- 用提供的座便盖进水软管连接三通和座便盖。
- 把三通用G1/2软管与供水系统相连。
- 在软管和电源线间扣上线夹。
- 打开供水系统。
- 检查所有连接是否有漏水，如果需要可做调整。

## 安装步骤:

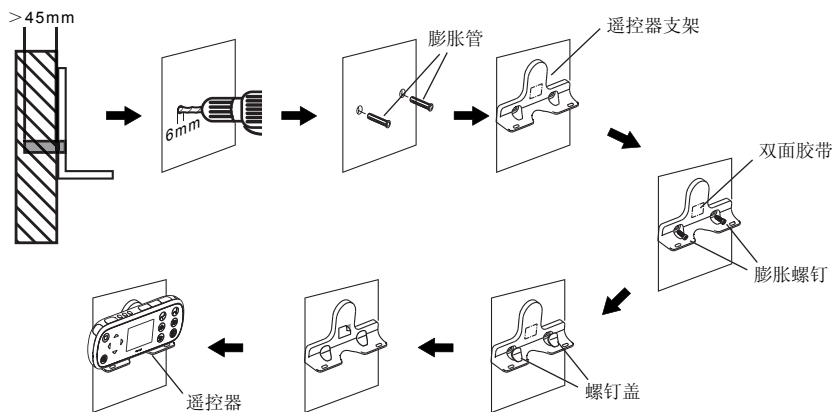

## 7. 安装遥控器支架

**注意:** 如果安装墙面是特定材料（比如木板、密制板等）时，使用合适的固定方法。

**注意:** 遥控器的安装位置应该是不易被水淋到的地方。

- 选择一个合适地方安装遥控器支架，这个地方应该是当你坐在座便器上时很容易用手容易操作遥控器。
- 根据遥控器支架螺钉孔的位置，用直径6mm的钻头在墙上钻两个深度大于45mm的孔。在孔中装入膨胀管。
- 将安装支架在放置固定孔上。
- 将支架背面双面胶离型纸撕掉。
- 用螺钉固定安装支架。
- 把螺钉盖装在螺钉上。
- 把遥控器放在支架上。





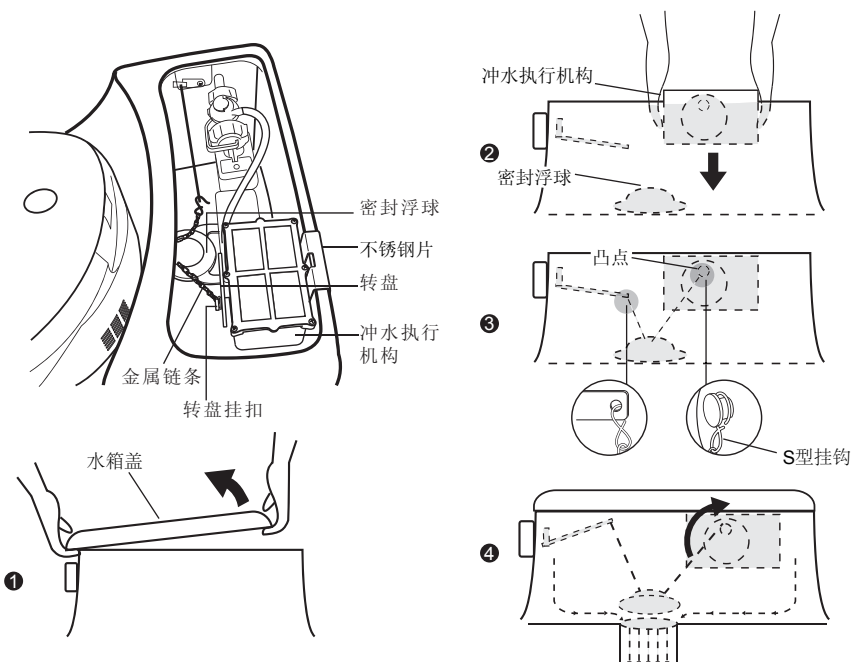

## 8. 冲水执行机构的安装及调试

- 移开水箱盖板。
- 在水箱中密封浮球的上方放置冲水执行机构。  
**注意：**执行机构在安装到水箱中时，可以调整不锈钢片的上下位置，以便水箱盖板盖到位。
- 用“金属链条”连接“冲水执行机构”的转盘凸点和“密封浮球”上的挂扣。  
**注意：**
  1. “密封浮球”上的挂扣点应靠近浮球。
  2. 与水箱的原有手动提拉金属条不要缠绕。
  3. 安装“金属链条”时根据不同水箱的配合情况，调整链条到合适的长度（调整S型挂钩在链条中的位置，保证多余的链条保留在S型挂钩一端）。
- 手动旋转“冲水执行机构”的转盘，确认转盘旋转过程中，能够将密封浮球完全提起，达到最佳冲水效果。
- 按遥控器上的  键，再次确认冲水执行机构工作正常。
- 盖好水箱盖板。

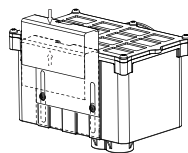

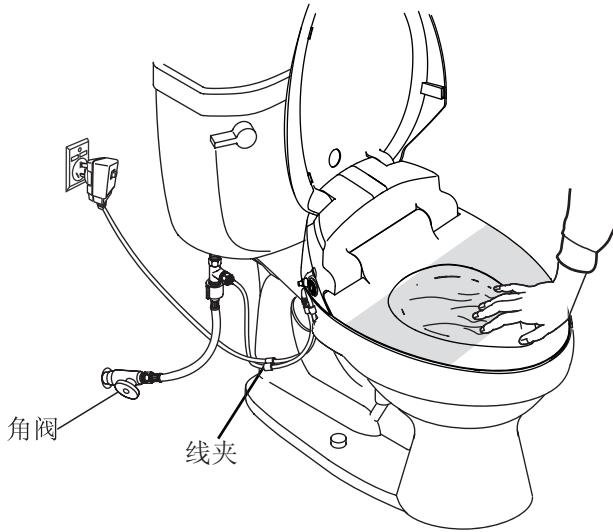

## 9. 试运行

- 用塑料片挡在座圈开口处，防止水溅出。
- 接通电源，按机体右侧的电源键，确保座便盖处于开机状态。
- 验证自动翻盖及冲水功能（见用户手册）。
- 在落座感应区域，放一片湿布或湿纸巾，模仿落座状态。验证冲洗功能（见用户手册）。
- 确认正常后，请务必取走落座感应区上的布或纸。