

# SWIMMING POOLS

LIBRO DE PISCINAS  
POOLS BOOK  
LIVRE DE PISCINES

**ape**grupo

# public & private swimming pools

piscinas públicas y privadas



**index**

índice

PRIVATE POOLS / PISCINAS PRIVADAS

17

**4.Stones**  
**Alabama**  
**Burlington**  
**Cross**  
**Deep Blue**  
**Illinois**  
**Koen**  
**Oregon**  
**Oxford**  
**Pierre de Bali**  
**Triana**  
**Vita**  
**Wabi Sabi**  
**Work**

PUBLIC POOLS / PISCINAS PÚBLICAS

143

**Dots**  
**Grooved**

TECHNICAL INFORMATION / INFORMACIÓN TÉCNICA

157



# Resistant by nature

Resistente por naturaleza

## LIFETIME MATERIALS

Pools have characteristics that require a series of solutions unthought of in other architectural fields. The continuous contact with water, the crossing of bare feet and the existing complex regulatory framework related to hygiene and safety demand design competences obtained through a specific experience in the field.

That is why our ceramic collections are composed of porcelain pieces and special extruded stoneware pieces that allow us to create public and private pool projects, providing with multiple solutions and making the interior of our spaces coexist perfectly with the pool.

## ES PARA TODA LA VIDA

Las características de las piscinas requieren una serie de soluciones que no se plantean en otros ámbitos arquitectónicos. El contacto continuo con el agua, el tránsito con pies descalzos y el complejo entramado normativo existente relativo a la higiene y la seguridad exigen competencias proyectuales que se obtienen mediante una experiencia específica en el campo.

Por este motivo nuestras colecciones cerámicas están compuestas de piezas de porcelánico y piezas especiales de gres extrusionado que nos permiten realizar proyectos de piscinas de ámbito público y privado aportando diversas soluciones y haciendo que el interior de nuestros espacios convivan a la perfección con la piscina.

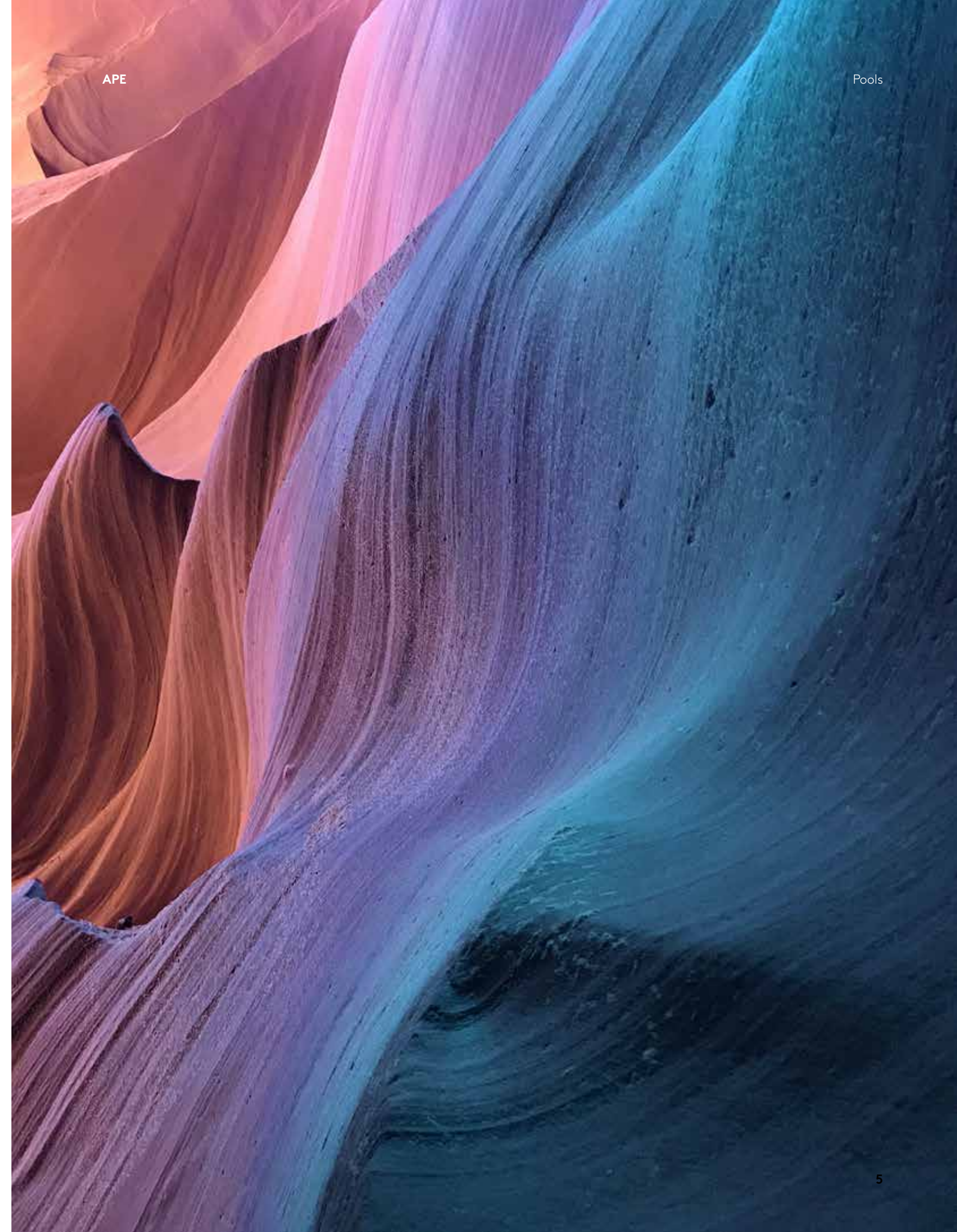



# In communion with nature

En comunión con la naturaleza

APE



## A UNIQUE EXPERIENCE

What is the pool of your dreams like?

When conceiving the construction of a pool, we must take into account that it is a fun and recreational area with maximum safety. That is why we must have pieces that not only guarantee quality and security, but also provide the swimming pool with a touch of beauty.

Limitless, with sights to the sea, in the middle of a garden, in a spa... No matter what the swimming pool of your dreams is like, all pools are a place to enjoy yourself, do some sport or relax. We take this into account when elaborating our product offer.

## UNA EXPERIENCIA ÚNICA

¿Cómo es la piscina de tus sueños?

Cuando se proyecta la construcción de una piscina se debe tener en cuenta que es un área de diversión y esparcimiento con la máxima seguridad. Es por ello que se debe contar con piezas que garanticen la calidad y seguridad, pero también que aporten un plus de belleza.

Sin límites, con vistas al mar, en medio del jardín, en un spa, sea cuál sea y cómo sea la piscina de tus sueños, todas ellas son un lugar en el que disfrutar, hacer deporte o desconectar. Esto es tenido en cuenta a la hora de elaborar la oferta de productos de la firma.



# Pools

**APE offers two types of systems for the construction of private pools: the traditional pool with skimmers and the overflow pool.**

APE ofrece dos tipos de sistemas para la construcción de piscinas privadas: la piscina tradicional con skimmer y la piscina de coronación desbordante.



TRADITIONAL POOL/PISCINA TRADICIONAL



OVERFLOW POOL/PISCINA DESBORDANTE

## TRADITIONAL POOL

Basic, or traditional, pools with skimmer system are those in which the water level is 20 centimeters below the edges and can have rectangular, irregular or mixed form.

## PISCINA TRADICIONAL

La piscina básica o tradicional con sistema skimmer es aquella en la que el nivel del agua se sitúa a unos 20 centímetros por debajo de los bordes y puede tener forma rectangular, irregular o mixta.

## OVERFLOW POOL

Infinity pools have the water at the same level as the superior part of the terrace. Water laps at and spills over the pool's perimeter edge, obtaining a beautiful, attractive and unique visual effect.

## PISCINA DESBORDANTE

La piscina desbordante es la que tiene el agua al mismo nivel que la parte superior de la playa. El agua rebosa el borde perimetral de la piscina consiguiendo un gran atractivo estético y un efecto visual inigualable.

## Natural elegance

Elegancia natural

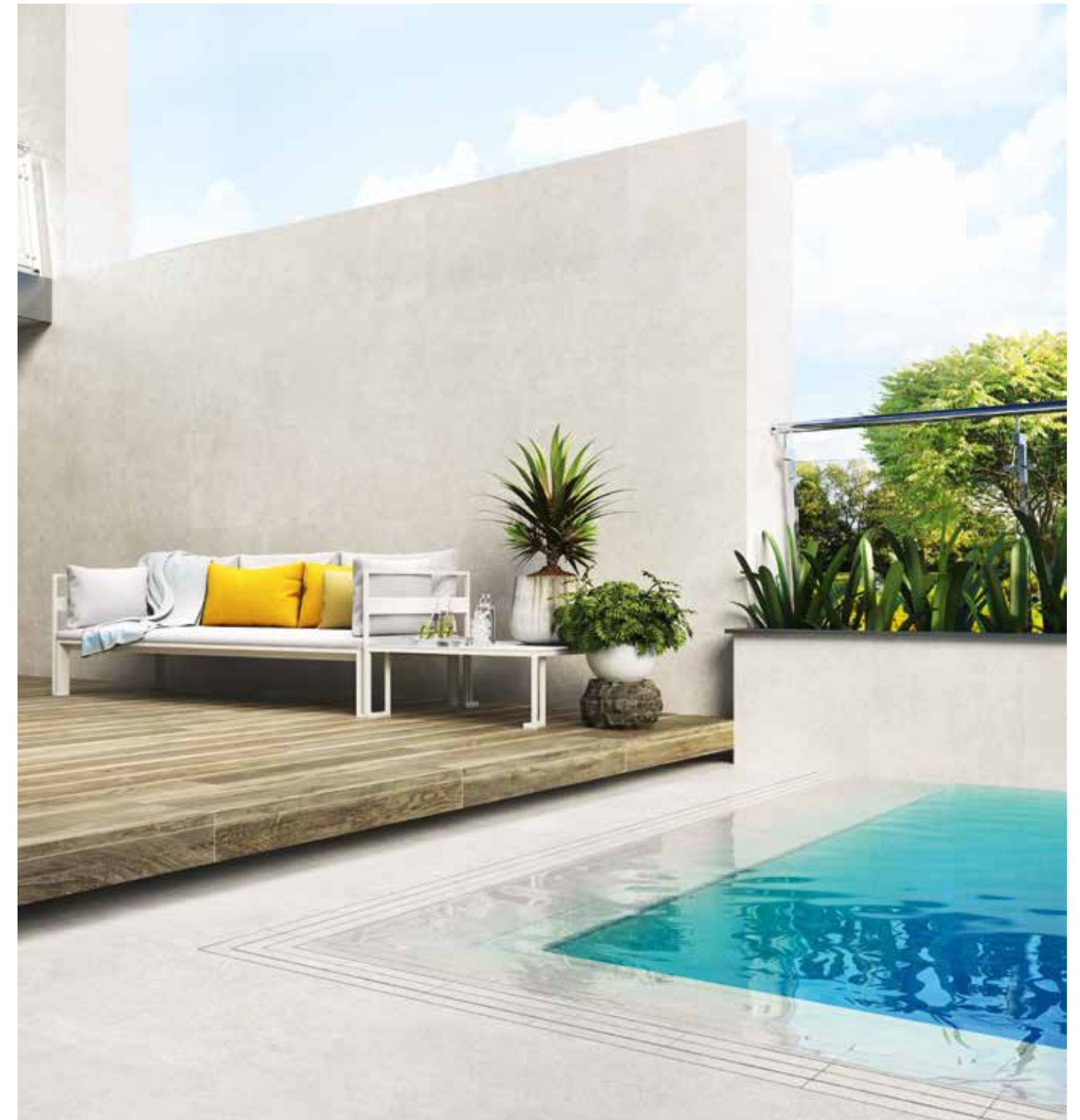



# Pools

Which style do you want to give to your pool? Classic, cosmopolitan, Ibiza, Provence, minimalist, zen, contemporary, chic, bohemian... Explore all the colors and combinations and customize your design.

¿Qué estilo quieres darle a tu piscina? Clásico, cosmopolita, ibicenco, provenzal, minimalista, zen, contemporáneo, chic, bohemio. Explora todos los colores y combinaciones y personaliza tu diseño.

## A PORCELAIN STONEWARE POOL

APE's porcelain satisfies the criteria of an innovative architecture and joins aesthetics with advanced technological performances.

It is anti-slip and resistant to abrasion, fire and contact with water, as well as chemical products. It is, therefore, the ideal material for public and residential environments. Moreover, it guarantees a perfect inalterability to the passing of time and, thanks to digital technology, has multiple designs inspired by marble, wood, stone or concrete, which respond to any aesthetic need.

## A EXTRUDED STONEWARE POOL

The porcelain offer is complemented with a series of extruded stoneware ceramic pieces. Pieces that resolve both aesthetic and, technically, any type of environment. They stand out for their quality, durability and variety. They also are easy to maintain and resistant to chemical agents. In addition, they are highly anti-slip, since they are also conceived for covering the swimming pool perimeter.

Top pieces, such as mesh strainers, flashings or steps, are placed here. These pieces constitute a perfect covering both for the swimming pool tank and perimeter of public and private spaces.

## UNA PISCINA DE GRES PORCELÁNICO

El porcelánico de APE satisface los criterios de una arquitectura innovadora y aúna estética con altas prestaciones tecnológicas.

Es antideslizante, resistente a la abrasión, al fuego y al contacto con el agua así como a los productos químicos. Es, por tanto, el material idóneo para ambientes residenciales y públicos. Además, garantiza una óptima inalterabilidad al paso del tiempo y gracias a la tecnología digital cuenta con diseños variados inspirados en el mármol, las maderas, piedras o cementos que responden a cualquier necesidad estética.

## UNA PISCINA DE GRES EXTRUIDO

La oferta de porcelánico se complementa con una serie de piezas cerámicas en gres extruido. Piezas que solucionan tanto estética como técnicamente cualquier tipo de entorno y que se caracterizan por su calidad y durabilidad, variedad, fácil mantenimiento y resistencia a los agentes químicos. Además al ser piezas pensadas también para recubrir la playa de la piscina son altamente antideslizantes.

Se sitúan aquí piezas de coronación, rejillas, vierteaguas, peldaño... piezas que constituyen un recubrimiento ideal para el vaso como la playa de la piscina de espacios hídricos públicos o privados.



01\_



02\_



03\_



04\_



05\_

- 01\_ OREGÓN
- 02\_ WORK
- 03\_ OXFORD
- 04\_ WABI SABI
- 05\_ OXFORD



**What color will my pool water look like?**

**The blue shade for the pool seems an obvious choice if we want the water to look this color too. But nothing could be more untrue. There are other options to achieve other shades such as turquoise or sky blue.**

¿De qué color se verá el agua de mi piscina?

El tono azul para la piscina parece una elección obvia si queremos que el agua también se vea de este color. Pero nada más lejos de la realidad. Existen otras opciones que permiten conseguir otros tonos como los turquesas o los tonos azul cielo.

**WHY DOES WATER LOOK BLUE IF IT IS TRANSPARENT?**

Basically, water absorbs long light wavelengths - red, orange or yellow - and reflects short light wavelengths, such as blue. That bouncing color is what you actually see in water. It is therefore an optical effect that depends on the light, so the color changes depending on whether the pool is indoors or outdoors, whether it is day or night, or whether it is lit up.

**¿POR QUÉ EL AGUA SE VE AZUL SI ES TRANSPARENTE?**

Básicamente el agua absorbe las longitudes de luz de onda larga — rojo, naranja o amarillo — y refleja las de onda corta, como los azules. Ese color que rebota es precisamente el que se ve en el agua. Se trata pues de un efecto óptico que depende de la luz, por lo que el color varía en función de si la piscina es interior o exterior, si es de día o de noche o si está iluminada.

**WHAT RESULTS WILL I GET WITH EACH COLOR?**

White shades, such as white ceramic marble, achieve an intense Caribbean blue that will give you a fresh, tropical look. In contrast, intense brown and earth shades will produce a very interesting greenish effect. Light beiges, typical of natural ceramic stone, can help us create turquoise shades. And with grays, as they are neutral, an intense and dark blue shade is achieved. In addition, grays help to conceal the dust and impurities that accumulate at the bottom of the pool.

**¿QUÉ RESULTADOS CONSEGUIRÉ CON CADA COLOR?**

Los **tonos blancos**, como el mármol blanco cerámico, consiguen un azul intenso caribeño que le dará un aspecto tropical y fresco. Por el contrario los **tonos marrones y tierra** intensos harán un efecto verdoso muy interesante. Los **beiges claros** propios de la piedra natural cerámica, nos pueden ayudar a crear tonos turquesas. Y con los **grises**, al ser neutros, se consigue un tono azul intenso y oscuro. Además los grises ayudan a disimular el polvo e impurezas que se acumulan en el fondo de la piscina.



01\_ BLANCOS  
02\_ MARRON  
03\_ BEIGE CLARO  
04\_ GRIS



# symbolology

simbología

- |  |   |
|--|---|
| <b>P</b> PORCELÁNICO/PORCELAIN TILES                           | <b>N</b> EXTRUSIONADO/EXTRUDED KLINKER                |
| <b>PR</b> PASTA ROJA/RED BODY                                  | <b>C0</b> CLASE 0/CLASS 0                             |
| <b>PB</b> PASTA BLANCA/WHITE BODY                              | <b>C1</b> CLASE 1/CLASS 1                             |
| <b>R</b> REVESTIMIENTO/WALL TILE                               | <b>C2</b> CLASE 2/CLASS 2                             |
| <b>F</b> PAVIMENTO/FLOOR TILE                                  | <b>C3</b> CLASE 3/CLASS 3                             |
| <b>B</b> BRILLO/SHINE  | <b>R9</b> ANTI-SLIP R9                                |
| <b>M</b> MATE/MATT   | <b>R10</b> ANTI-SLIP R10                              |
| <b>S</b> SATINADO/SATIN  | <b>R11</b> ANTI-SLIP R11                              |
| <b>P*</b> PULIDO BRILLO/SHINE POLISHED                         | <b>R12</b> ANTI-SLIP R12                              |
| <b>M*</b> PULIDO MATE/MATT POLISHED                            | <b>A+B</b> ANTI-SLIP BAREFOOT A+B                     |
| <b>L*</b> LAPATTO/LAPPED                                       | <b>A+B+C</b> ANTI-SLIP BAREFOOT A+B+C                 |
| <b>L*</b> LAPATTO MATE/MATT LAPPED                             | <b>(DCOF) &gt;0.50</b>                                |
| <b>G</b> GRANILLA PULIDA/GRAIN POLISHED GLASS EFFECT           | <b>J</b> JUNTA RECOMENDADA 5MM/RECOMMENDED JOINT 0,2" |
| <b>E</b> ESMALTE PULIDO/GLAZE POLISHED SHINY                   | <b>T</b> ESPESOR 10MM/THICKNESS 0,4"                  |
| <b>R</b> RECTIFICADO/RECTIFIED                                 | <b>V1</b> ASPECTO UNIFORME/UNIFORM APPEARANCE         |
| <b>M</b> MASA COLOREADA/COLORED BODY                           | <b>V2</b> VARIACION LEVE/SLIGHT VARIATION             |
| <b>T</b> ESPESORADO/THICKNESS                                  | <b>V3</b> VARIACION MODERADA/MODERATE VARIATION       |
| <b>M</b> MODULARIDAD/MODULARITY                                | <b>V4</b> VARIACION FUERTE/SUBSTANTIAL VARIATION      |
| <b>G</b> VARIACIÓN DE DISEÑO XX PIEZAS/GRAPHIC FACES XX PIECES |   |

# reading the catalogue

lectura del catálogo

**01**

Nombre de la colección/  
Collection name

**02**

Aplicación de la pieza/  
Application of the piece

**03**

Descripción gráfica de la pieza/  
Graphic description

**04**

Características de la pieza/  
Piece characteristics

**05**

Nombre de la colección/  
Collection name

**06**

Tipología de la colección/  
Typology collection

**07**

Número de página/  
Page number

## Wabi Sabi

**PELDAÑO RECTO**  
WABI

**01** PELDAÑO RECTO ANT. C3 WABI BLANCO 33 x 100 / 13" x 40" **K91/P**    **02** PELDAÑO RECTO ANT. C3 WABI GRANITE 33 x 100 / 13" x 40" **K91/P**    **03** PELDAÑO RECTO ANT. C3 WABI SABBIA 33 x 100 / 13" x 40" **K91/P**    **04** PELDAÑO RECTO ANT. C3 WABI TALPE 33 x 100 / 13" x 40" **K91/P**

ZANQUIN RECTO DCHA. (DQ) WABI BLANCO 75 x 60 / 3" x 24" **K20/P**    ZANQUIN RECTO DCHA. (DQ) WABI GRANITE 75 x 60 / 3" x 24" **K20/P**    ZANQUIN RECTO DCHA. (DQ) WABI SABBIA 75 x 60 / 3" x 24" **K20/P**    ZANQUIN RECTO DCHA. (DQ) WABI TALPE 75 x 60 / 3" x 24" **K20/P**

REMATE PELDAÑO RECTO WABI BLANCO 3,2 x 33 / 1/8" x 13" **K36/P**    REMATE PELDAÑO RECTO WABI GRANITE 3,2 x 33 / 1/8" x 13" **K36/P**    REMATE PELDAÑO RECTO WABI SABBIA 3,2 x 33 / 1/8" x 13" **K36/P**    REMATE PELDAÑO RECTO WABI TALPE 3,2 x 33 / 1/8" x 13" **K36/P**

TABICA WABI BLANCO 15 x 100 / 6" x 40" **K75/P**    TABICA WABI GRANITE 15 x 100 / 6" x 40" **K75/P**    TABICA WABI SABBIA 15 x 100 / 6" x 40" **K75/P**    TABICA WABI TALPE 15 x 100 / 6" x 40" **K75/P**

**04** **CARACTERÍSTICAS TÉCNICAS - TECHNICAL CHARACTERISTICS**

<b>N</b> EXTRUSIONADO/EXTRUDED KLINKER	<b>B</b> ANTI-SLIP R11
<b>M</b> MATE/MATT	<b>(DCOF) &gt;0.50</b>
<b>R</b> RECTIFICADO/RECTIFIED	<b>C</b> CLASE 3-CLASS 3
<b>V2</b> VARIACION LEVE/SLIGHT VARIATION	<b>A+B</b> ANTI-SLIP BAREFOOT A+B

**03** **05** **06** **07**

## Wabi Sabi Pools

**PELDAÑO RECTO**  
TRAVERTINO

**05** PELDAÑO RECTO ANT. C3 TRAVERTINO SILVER 33 x 100 / 13" x 40" **K91/P**    **06** PELDAÑO RECTO ANT. C3 TRAVERTINO BRESCIA 33 x 100 / 13" x 40" **K91/P**    **07** PELDAÑO RECTO ANT. C3 MADAGASCAR NOCE 33 x 100 / 13" x 40" **K91/P**

ZANQUIN RECTO DCHA. (DQ) TRAVERTINO SILVER POL. 75 x 60 / 3" x 24" **K20/P**    ZANQUIN RECTO DCHA. (DQ) TRAVERTINO BRESCIA POL. 75 x 60 / 3" x 24" **K20/P**    ZANQUIN RECTO DCHA. (DQ) MADAGASCAR NOCE 75 x 60 / 3" x 24" **K20/P**

REMATE PELDAÑO RECTO TRAVERTINO SILVER 3,2 x 33 / 1/8" x 13" **K36/P**    REMATE PELDAÑO RECTO TRAVERTINO BRESCIA 3,2 x 33 / 1/8" x 13" **K36/P**    REMATE PELDAÑO RECTO MADAGASCAR NOCE 3,2 x 33 / 1/8" x 13" **K36/P**

TABICA TRAVERTINO SILVER 15 x 100 / 6" x 40" **K75/P**    TABICA TRAVERTINO BRESCIA 15 x 100 / 6" x 40" **K75/P**    TABICA MADAGASCAR NOCE 15 x 100 / 6" x 40" **K75/P**

**PELDAÑO FIORENTINO**  
TRAVERTINO

**05** PELDAÑO FOR. ANT. C3 TRAVERTINO SILVER 33x100 / 13" x 40" **K91/P**    **06** PELDAÑO FOR. ANT. C3 TRAVERTINO BRESCIA 33x100 / 13" x 40" **K91/P**

REMATE FORJIDOR.FE.LO. TRAVERTINO SILVER 3,2x33 / 1/8" x 13" **K36/P**    REMATE FORJIDOR.FE.LO. TRAVERTINO BRESCIA 3,2x33 / 1/8" x 13" **K36/P**

REMATE FORJIDOR.FE.LO. TRAVERTINO SILVER 3,2x33 / 1/8" x 13" **K36/P**    REMATE FORJIDOR.FE.LO. TRAVERTINO BRESCIA 3,2x33 / 1/8" x 13" **K36/P**





# collections

colecciones

## 4.Stones

18

## Alabama

26

## Burlington

34

## Cross

44

## Deep Blue

50

## Illinois

54

## Koen

64

## Oregon

70

## Oxford

76

## Pierre de Bali

88

## Triana

94

## Vita

98

## Wabi Sabi

108

## Work

130



# 4.Stones

**Original or copy?  
Natural or digital?**

At APE we question these pairs of contrary concepts with a collection of four stone tiles that defy the limits of manufacturing. Reproductions full of authenticity and their own essence, 4.Stones is a new way of understanding design, where quality, naturalness and sustainability go hand in hand.

**¿Original o copia?  
¿Natural o digital?**

En APE ponemos en duda esta dualidad de conceptos contrarios con una colección de cuatro piedras cerámicas que desafían los límites de la fabricación. Reproducciones llenas de autenticidad y sabor propio, 4.Stones es una nueva forma de entender el diseño, donde calidad, naturalidad y también sostenibilidad se dan la mano.

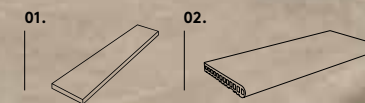

01. ANTI-SLIP BOURG RECT 60X120/24"X48" 02. BORDE PISCINA BOURG 28X66,5/11"X26"



# 4.Stones



01. ANTI-SLIP VALMALENCO RECT 60X120/24"X48"  
 02. ANGULO PISCINA INT. VALMALENCO 33X33/13"X13"  
 03. BORDE PISCINA VALMALENCO 28X66,5/11"X26"

## PELDAÑO RECTO



**C3** PELDAÑO RECTO ANT. C3 BOURG  
 33 X 120 / 13" X 48" K91/P



**C3** PELDAÑO RECTO ANT. C3 VALMALENCO  
 33 X 120 / 13" X 48" K91/P



REMATE RECTO PELD. BOURG  
 3.2 X 33 / 1.5" X 13" K36/P



REMATE RECTO PELD. VALMALENCO  
 3.2 X 33 / 1.5" X 13" K36/P

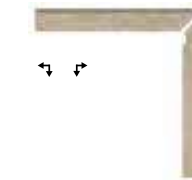

ZANQUIN RECTO DCHA./IZQ. BOURG  
 7,5 X 60 / 3" X 24" K09/P

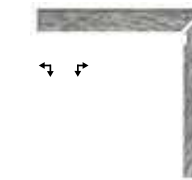

ZANQUIN RECTO DCHA./IZQ. VALMALENCO  
 7,5 X 60 / 3" X 24" K09/P



TABICA BOURG  
 15 X 120 / 6" X 48" K11/P



TABICA VALMALENCO  
 15 X 120 / 6" X 48" K11/P



ROD. BOURG / ROD. BOURG LAP  
 7,5x60/3"X24" K24/P

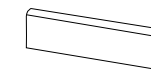

ROD. VALMALENCO / ROD. VALMALENCO LAP  
 7,5x60/3"X24" K24/P  
 ROD. VALMALENCO  
 7,5X90/ 3"X36" K14/P

## TRADITIONAL POOL / PISCINA TRADICIONAL



REF. 232 UÑA BOURG  
 4 X 4 / 1.5" X 1.5" K06/P



BORDE PISCINA BOURG  
 28 X 66.5 / 11" X 26" K94/P



BORDE PISCINA VALMALENCO  
 28 X 66.5 / 11" X 26" K94/P



REF. 222 MEDIA CAÑA BOURG  
 4 X 33 / 1.5" X 33" K29/P



ANGULO PISCINA INT. BOURG  
 33 X 33 / 13" X 13" K39/P



ANGULO PISCINA INT. VALMALENCO  
 33 X 33 / 13" X 13" K39/P

### CARACTERÍSTICAS TÉCNICAS - TECHNICAL CHARACTERISTICS

EXTRUSIONADO/EXTRUDED KLINKER RECTIFICADO/RECTIFIED **C3** CLASE 3/CLASS 3 **R11** ANTI-SLIP R11 ANTI-SLIP BAREFOOT A+B+C



# 4.Stones

## BASES



**M C2 R10 V2** BOURG RECT  
60 X 120 / 24" X 48"

P20/M



**M V2** RELIEVO BOURG RECT  
60 X 120 / 24" X 48"

P23/M

**M C3 R11 V2** ANTI-SLIP BOURG RECT  
60 X 120 / 24" X 48"

P25/M

**\* V2** BOURG LAP RECT  
60 X 120 / 24" X 48"

P19/M



**M V2** RELIEVO BOURG RECT  
30 X 120 / 12" X 48"

P24/M



**M V2** RELIEVO BOURG RECT  
20 X 120 / 8" X 48"

P24/M

### CARACTERÍSTICAS TÉCNICAS · TECHNICAL CHARACTERISTICS

- P** PORCELÁNICO/PORCELAIN TILES
- M** MASA COLOREADA/COLORED BODY
- R** RECTIFICADO/RECTIFIED
- T** ESPESOR/THICKNESS:  
10mm/0,39"  
40X120 - 20mm/0,79"

## BASES



**M C3 R11 V2** BOURG RECT\*  
40 X 120 (2CM) / 16" X 48"

P28/M

\*Espesor 20mm / thickness 0.8"



ESPEJORADO / HIGH THICKNESS



RELIEVO

LAPATTO

MATT



# 4.Stones

## BASES

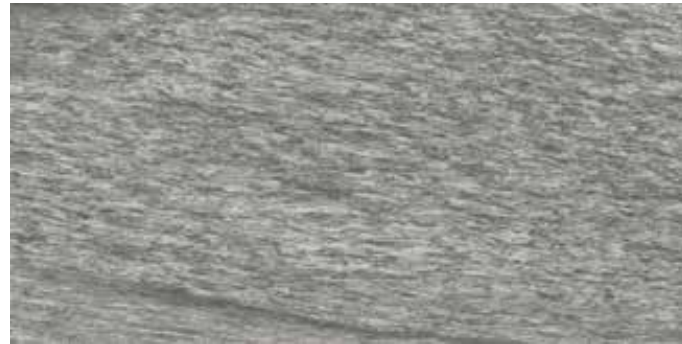

**M C2 R10 V3** VALMALENCO RECT  
60 X 120 / 24" X 48"

P20/M

**M C3 R11 V3** ANTI-SLIP VALMALENCO RECT  
60 X 120 / 24" X 48"

P25/M

**V3** VALMALENCO LAP RECT  
60 X 120 / 24" X 48"

P19/M



**M C2 R10 V3** VALMALENCO RECT  
30 X 120 / 12" X 48"

P22/M

**V3** VALMALENCO LAP RECT  
30 X 120 / 12" X 48"

P21/M



**M C2 R10 V3** VALMALENCO RECT  
20 X 120 / 8" X 48"

P22/M

**V3** VALMALENCO LAP RECT  
20 X 120 / 8" X 48"

P21/M



**M V3** RELIEVO VALMALENCO RECT  
60 X 120 / 24" X 48"

P23/M



**M V3** RELIEVO VALMALENCO RECT  
30 X 120 / 12" X 48"

P24/M



**M V3** RELIEVO VALMALENCO RECT  
20 X 120 / 8" X 48"

P24/M

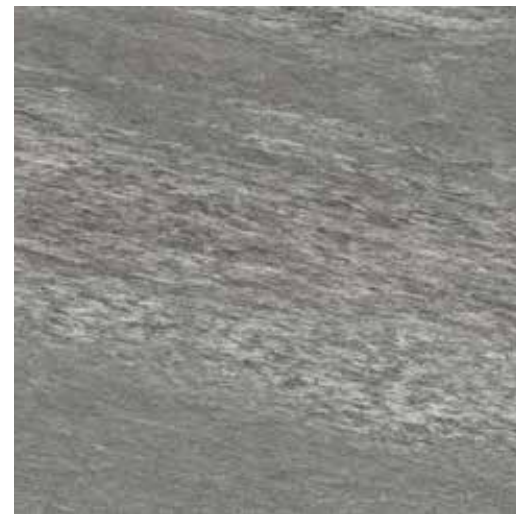

**M C2 R10 V3** VALMALENCO RECT  
90 X 90 / 36" X 36"

P10/M

### CARACTERÍSTICAS TÉCNICAS · TECHNICAL CHARACTERISTICS

- P** PORCELÁNICO / PORCELAIN TILES
- R** RECTIFICADO / RECTIFIED
- M** MASA COLOREADA / COLORED BODY
- E** ESPESOR / THICKNESS:  
10mm / 0,39"  
40X120 - 20mm / 0,79"

## BASES

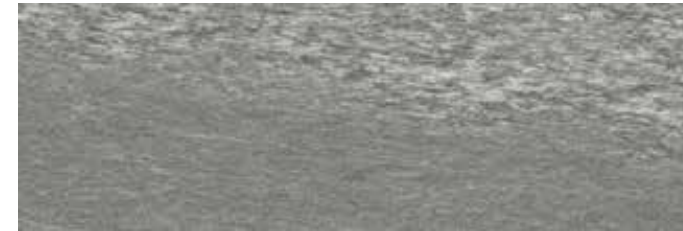

**M C3 R11 V3** VALMALENCO RECT  
40 X 120 (2CM) / 16" X 48"

P28/M

\*Espesor 20mm / thickness 0.8"



ESPEJORADO / HIGH THICKNESS



RELIEVO

MATT



# Alabama

**A lifelong wood finish.**

**Un acabado en madera para toda la vida.**

Alabama is a versatile collection of ceramic woods that works as the skin of the space. Its timeless beauty allows this series to match with different decorative styles. Alabama is designed to achieve global integration in all the spaces of the house: indoors, outdoors and swimming pool, covering the tank and the top throughout the traditional straight step system.

Alabama es una colección de maderas cerámicas versátil que funciona como piel del espacio. Su belleza atemporal la convierten en una serie que combina con diferentes estilos decorativos. Alabama está diseñada para lograr una integración global en todos los espacios de la vivienda: interior y exterior incluyendo la piscina, recubriendo el vaso y la coronación mediante el sistema tradicional con peldaño recto.

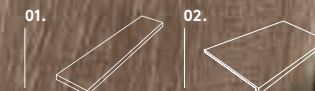
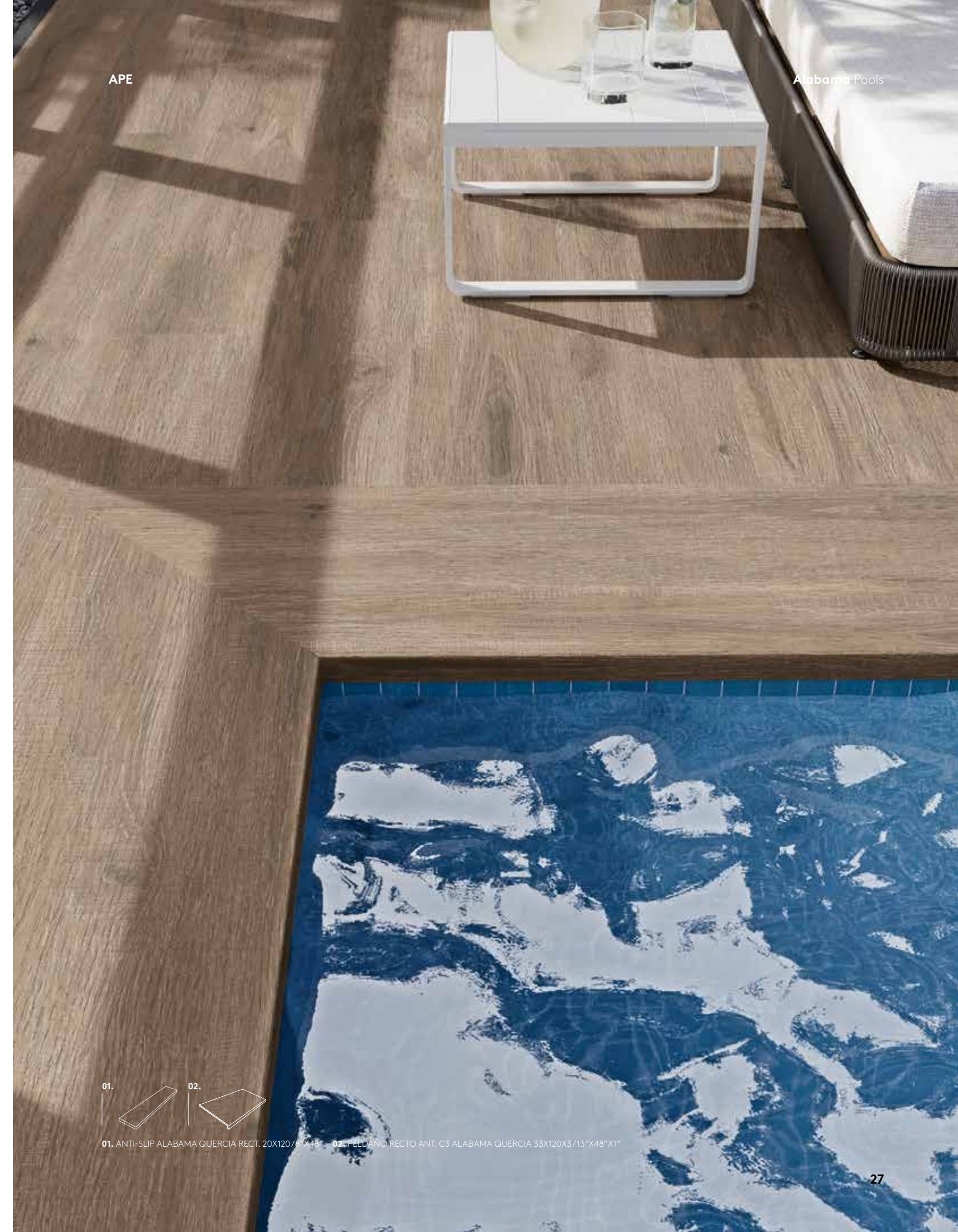

01. ANTI-SLIP ALABAMA QUERCIA RECT. 20X120/8"X48" - 02. Peldaño RECTO ANT. C3 ALABAMA QUERCIA 33X120X3 /13"X48"X1"



# Alabama

APE

Alabama Pools

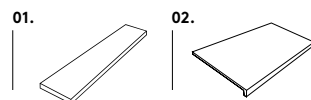

01. ANTI-SLIP ALABAMA QUERCIA RECT. 20X120/8"X48" 02. PELDAÑO RECTO ANT. C3 ALABAMA QUERCIA 33X120X3/13"X48"X1"



# Alabama

APE

Alabama Pools



Traditional pools are efficient and its maintenance is simple. We have straight steps for them that will provide the swimming pool with a very contemporary touch.

Las piscinas tradicionales son eficientes y su mantenimiento es sencillo. Para ellas contamos con un peldaño recto que le dará un toque contemporáneo y muy actual a la piscina.

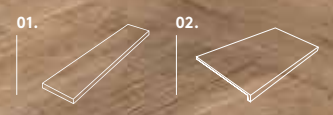
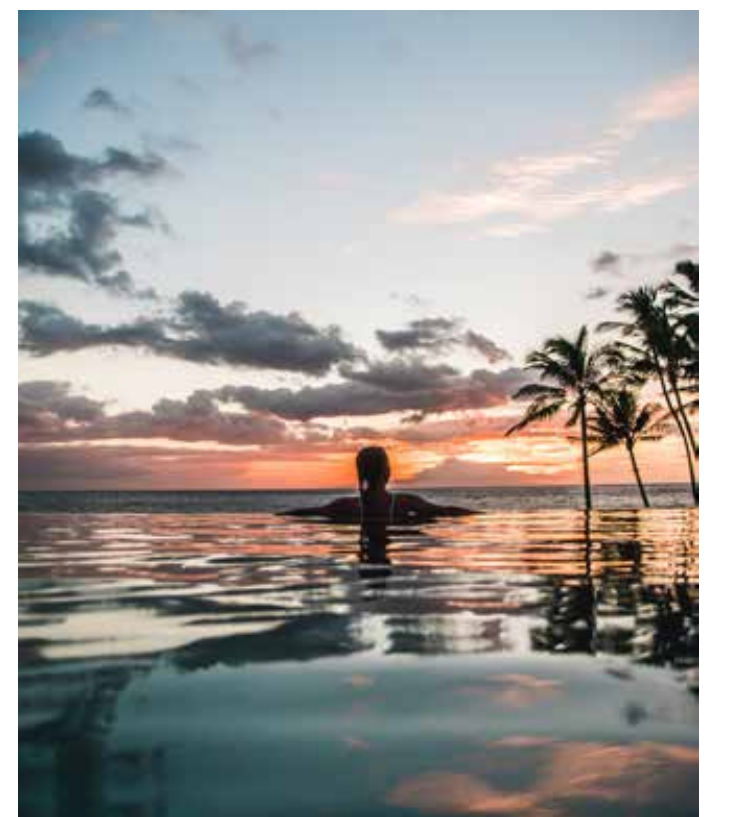

01. ANTI-SLIP ALABAMA SÁNDALO RECT. 20X120/8"X48" 02. PELDAÑO RECTO ANT. C3 ALABAMA SÁNDALO 33X120X3/13"X48"X1"



## PELDAÑO RECTO



**C3** PELDAÑO RECTO ANT. C3 ALABAMA NEBBIA  
33 X 120 / 13" X 48" **K91/P**



**C3** PELDAÑO RECTO ANT. C3 ALABAMA CENERE  
33 X 120 / 13" X 48" **K91/P**



**C3** PELDAÑO RECTO ANT. C3 ALABAMA SÁNDALO  
33 X 120 / 13" X 48" **K91/P**



REMATE RECTO PELD. ALABAMA NEBBIA  
3.2 X 33 / 1.5" X 13" **K36/P**



REMATE RECTO PELD. ALABAMA CENERE  
3.2 X 33 / 1.5" X 13" **K36/P**



REMATE RECTO PELD. ALABAMA SÁNDALO  
3.2 X 33 / 1.5" X 13" **K36/P**



TABICA ALABAMA NEBBIA  
15 X 120 / 6" X 48" **K11/P**



TABICA ALABAMA CENERE  
15 X 120 / 6" X 48" **K11/P**



TABICA ALABAMA SÁNDALO  
15 X 120 / 6" X 48" **K11/P**

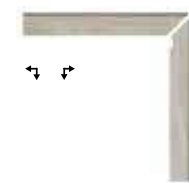

ZANQUIN RECTO DCHA./IZQ. ALABAMA NEBBIA  
8 X 60 / 3" X 24" **K09/P**



ZANQUIN RECTO DCHA./IZQ. ALABAMA CENERE  
8 X 60 / 3" X 24" **K09/P**



ZANQUIN RECTO DCHA./IZQ. ALABAMA SÁNDALO  
8 X 60 / 3" X 24" **K09/P**



**C3** PELDAÑO RECTO ANT. C3 ALABAMA QUERCIA  
33 X 120 / 13" X 48" **K91/P**



REMATE RECTO PELD. ALABAMA QUERCIA  
3.2 X 33 / 1.5" X 13" **K36/P**



TABICA ALABAMA QUERCIA  
15 X 120 / 6" X 48" **K11/P**

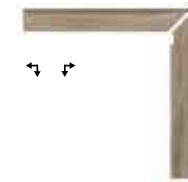

ZANQUIN RECTO DCHA./IZQ. ALABAMA QUERCIA  
8 X 60 / 3" X 24" **K09/P**

### CARACTERÍSTICAS TÉCNICAS · TECHNICAL CHARACTERISTICS

- K** EXTRUSIONADO/EXTRUDED KLINKER
- M** MATE/MATT
- R** RECTIFICADO/RECTIFIED
- V3** VARIACION MODERADA/MODERATE VARIATION
- R11** ANTI-SLIP R11
- A+B+C** ANTI-SLIP BAREFOOT A+B+C
- (DCOF)** >0.50
- C3** CLASE 3/CLASS 3

DORSO ESTRIADO EN COLA DE MILANO. DOVE TAIL PROFILE.

JUNTA RECOMENDADA 5 MM. RECOMMENDED JOINT BETWEEN PIECES 5 MM.

## BASES



**C2 R10** ALABAMA NEBBIA RECT  
20 X 120 / 8" X 48" **R53/M**

**C3 R11** ANTI-SLIP ALABAMA NEBBIA RECT  
20 X 120 / 8" X 48" **N71/M**



**C2 R10** ALABAMA CENERE RECT  
20 X 120 / 8" X 48" **R53/M**

**C3 R11** ANTI-SLIP ALABAMA CENERE RECT  
20 X 120 / 8" X 48" **N71/M**



**C2 R10** ALABAMA QUERCIA RECT  
20 X 120 / 8" X 48" **R53/M**

**C3 R11** ANTI-SLIP ALABAMA QUERCIA RECT  
20 X 120 / 8" X 48" **N71/M**



**C2 R10** ALABAMA SÁNDALO RECT  
20 X 120 / 8" X 48" **R53/M**

**C3 R11** ANTI-SLIP ALABAMA SÁNDALO RECT  
20 X 120 / 8" X 48" **N71/M**

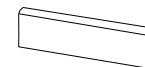

ROD. ALABAMA  
8 X 60 / 3" X 24" **K24/P**

AVAILABLE IN ALL COLORS / DISPONIBLE EN TODOS LOS COLORES

### CARACTERÍSTICAS TÉCNICAS · TECHNICAL CHARACTERISTICS

- P** PORCELÁNICO/PORCELAIN TILES
- M** MATE/MATT
- V3** VARIACION MODERADA/MODERATE VARIATION
- R** RECTIFICADO/RECTIFIED
- E** ESPESOR/THICKNESS:  
20X120 - 10,5mm/0,41"



# Burlington

**In this series we have worked on the graphic qualities that natural stone offers.**

**En esta serie hemos trabajado las cualidades gráficas que presenta la piedra natural**

Deep in the mountains of Cumbria, UK, the purity of Lakeland water, volcanic ash, weathering and mineral processes have slowly formed Burlington. For centuries, this iconic stone, which has inspired our collection with the same name, has given life to beautiful interiors, naturally carved works and majestic spaces.

En las profundidades de las montañas de Cumbria (Reino Unido), la pureza del agua de Lakeland, la ceniza volcánica, la intemperie y los procesos minerales forman lentamente Burlington. Durante siglos, esta icónica piedra, que ha inspirado nuestra colección con el mismo nombre, ha dado vida a interiores hermosos, a trabajos tallados de forma natural y a majestuosos espacios.



01. ANTI-SLIP BURLINGTON GREY RECT. 60X120/24"X48" 02. Peldaño Recto Ant. C3 Burlington Grey 33X120/13"X48"  
PIERRE DE BALI 15X15/6"X6" BURLINGTON GREY RECT. 60X120/24"X48"



# Burlington

APE

Burlington Pools

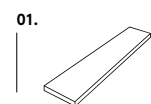

01. ANTI-SLIP BURLINGTON PEARL RECT. 60X120/24"X48"

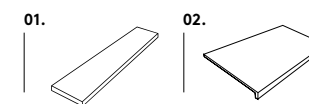

01. ANTI-SLIP BURLINGTON TAUPE RECT. 60X120/24"X48" 02. PELDAÑO RECTO ANT. C3 BURLINGTON TAUPE 33X120/13"X48"  
CONTEMPORARY BLUESTONE 15X15/6"X6"



# Burlington

APE

Burlington Pools

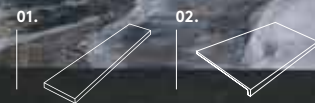

01. ANTI-SLIP BURLINGTON VOLCANO RECT. 75X75/30"X30" 02. PELDAÑO RECTO ANT. C3 BURLINGTON VOLCANO 33X120/13"X48"  
BURLINGTON VOLCANO RECT. 60X120/24"X48" ANTI-SLIP MADAGASCAR NOCE RECT. 20X120/8"X48" DEEP BLUE OXID 15X15/6"X6"





# Burlington

## BASES



BURLINGTON PEARL RECT.  
75X75 / 30"X30" **J57 /M**

**C3 R11** ANTI-SLIP BURLINGTON PEARL RECT.  
75X75 / 30"X30" **J58/M**



BURLINGTON PEARL RECT.  
60X120 / 24"X48" **J55/M**

**C3 R11** ANTI-SLIP BURLINGTON PEARL RECT.  
60X120 / 24"X48" **J56 /M**



BURLINGTON PEARL RECT.  
60X60 / 24"X24" **J59 /M**



BURLINGTON PEARL  
30X60 / 12"X24" **J27 /M**



BURLINGTON GREY RECT.  
75X75 / 30"X30" **J57 /M**

**C3 R11** ANTI-SLIP BURLINGTON GREY RECT.  
75X75 / 30"X30" **J58/M**

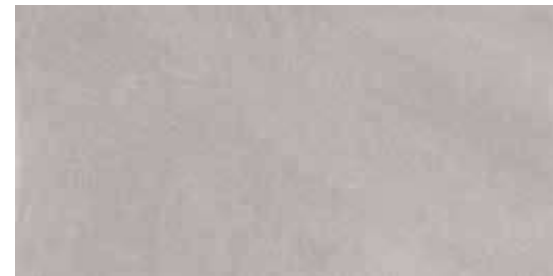

BURLINGTON GREY RECT.  
60X120 / 24"X48" **J55/M**

**C3 R11** ANTI-SLIP BURLINGTON GREY RECT.  
60X120 / 24"X48" **J56 /M**



BURLINGTON GREY RECT.  
60X60 / 24"X24" **J59 /M**



BURLINGTON GREY  
30X60 / 12"X24" **J27 /M**



BURLINGTON VOLCANO RECT.  
75X75 / 30"X30" **J57 /M**

**C3 R11** ANTI-SLIP BURLINGTON VOLCANO RECT.  
75X75 / 30"X30" **J58/M**

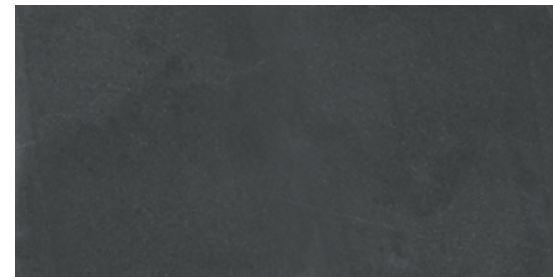

BURLINGTON VOLCANO RECT.  
60X120 / 24"X48" **J55/M**

**C3 R11** ANTI-SLIP BURLINGTON VOLCANO RECT.  
60X120 / 24"X48" **J56 /M**

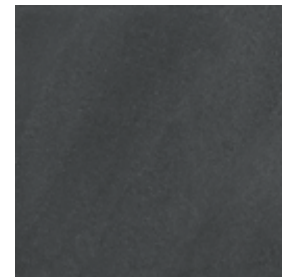

BURLINGTON VOLCANO RECT.  
60X60 / 24"X24" **J59 /M**



BURLINGTON VOLCANO  
30X60 / 12"X24" **J27 /M**

## BASES

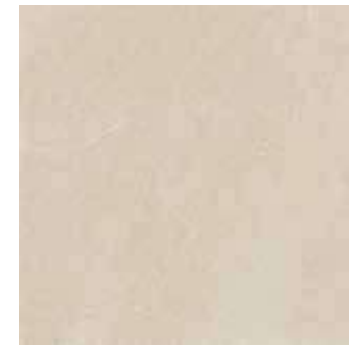

BURLINGTON IVORY RECT.  
75X75 / 30"X30" **J57 /M**

**C3 R11** ANTI-SLIP BURLINGTON IVORY RECT.  
75X75 / 30"X30" **J58/M**



BURLINGTON IVORY RECT.  
60X120 / 24"X48" **J55/M**

**C3 R11** ANTI-SLIP BURLINGTON IVORY RECT.  
60X120 / 24"X48" **J56 /M**



BURLINGTON IVORY RECT.  
60X60 / 24"X24" **J59 /M**



BURLINGTON IVORY  
30X60 / 12"X24" **J27 /M**



BURLINGTON TAUPE RECT.  
75X75 / 30"X30" **J57 /M**

**C3 R11** ANTI-SLIP BURLINGTON TAUPE RECT.  
75X75 / 30"X30" **J58/M**



BURLINGTON TAUPE RECT.  
60X120 / 24"X48" **J55/M**

**C3 R11** ANTI-SLIP BURLINGTON TAUPE RECT.  
60X120 / 24"X48" **J56 /M**

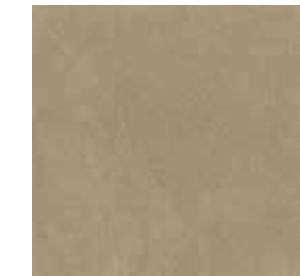

BURLINGTON TAUPE RECT.  
60X60 / 24"X24" **J59 /M**



BURLINGTON TAUPE  
30X60 / 12"X24" **J27 /M**

### CARACTERÍSTICAS TÉCNICAS · TECHNICAL CHARACTERISTICS



PORCELÁNICO/PORCELAIN TILES



RECTIFICADO/RECTIFIED



MASA COLOREADA/COLORED BODY



MATE/MATT



VARIACION LEVE/SLIGHT VARIATION



ESPESOR/THICKNESS:  
11mm/0,43"



CLASE 2 / CLASS 2



VARIACIÓN DE DISEÑO/GRAPHIC FACES:  
75X75- 12 PIEZAS/PIECES  
60X120- 12 PIEZAS/PIECES  
60X60-24 PIEZAS/PIECES  
30X60-48 PIEZAS/PIECES



# Burlington

APE

Burlington Pools

## PELDAÑO RECTO



**C3** PELDAÑO RECTO ANT. C3 BURLINGTON PEARL  
33 X 120 / 13" X 48" K91/P



**C3** PELDAÑO RECTO ANT. C3 BURLINGTON GREY  
33 X 120 / 13" X 48" K91/P



**C3** PELDAÑO RECTO ANT. C3 BURLINGTON VOLCANO  
33 X 120 / 13" X 48" K91/P

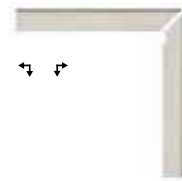

ZANQUIN RECTO DCHA./IZQ. BURLINGTON PEARL  
7,5 X 60/ 3" X 24" K09/P

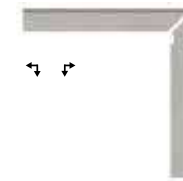

ZANQUIN RECTO DCHA./IZQ. BURLINGTON GREY  
7,5 X 60/ 3" X 24" K09/P

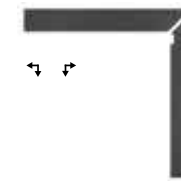

ZANQUIN RECTO DCHA./IZQ. BURLINGTON VOLCANO  
7,5 X 60/ 3" X 24" K09/P



**C3** PELDAÑO RECTO ANT. C3 BURLINGTON IVORY  
33 X 120 / 13" X 48" K91/P



**C3** PELDAÑO RECTO ANT. C3 BURLINGTON TAUPE  
33 X 120 / 13" X 48" K91/P

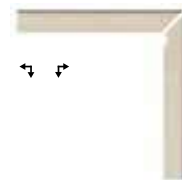

ZANQUIN RECTO DCHA./IZQ. BURLINGTON IVORY  
7,5 X 60/ 3" X 24" K09/P

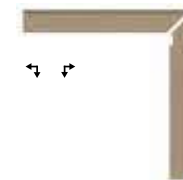

ZANQUIN RECTO DCHA./IZQ. BURLINGTON TAUPE  
7,5 X 60/ 3" X 24" K09/P

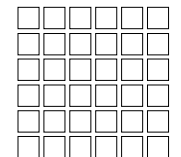

MOSAICO BURLINGTON  
30X30(5X5)/ 12"X12" K01/P

AVAILABLE IN ALL COLORS / DISPONIBLE EN TODOS LOS COLORES



ROD. BURLINGTON 7,5 X 60 / 3" X 24" K24/P

ROD. BURLINGTON 7,5 X 75 / 3" X 30" K18/P

AVAILABLE IN ALL COLORS / DISPONIBLE EN TODOS LOS COLORES

### CARACTERÍSTICAS TÉCNICAS · TECHNICAL CHARACTERISTICS



EXTRUSIONADO/EXTRUDED KLINKER



MATE/MATT



RECTIFICADO/RECTIFIED



VARIACION LEVE/SLIGHT VARIATION



ANTI-SLIP R11



ANTI-SLIP BAREFOOT A+B+C



(DCOF) >0.50



CLASE 3/CLASS 3



DORSO ESTRIADO EN COLA DE MILANO.  
DOVE TAIL PROFILE.



JUNTA RECOMENDADA 5 MM.  
RECOMMENDED JOINT BETWEEN PIECES 5 MM.

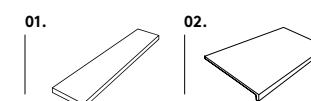

01. ANTI-SLIP BURLINGTON TAUPE RECT. 75X75/30"X30" 02. PELDAÑO RECTO ANT. C3 BURLINGTON IVORY 33X120/13"X48"  
BURLINGTON IVORY RECT. 60X120/24"X48" DEEP BLUE OXID 15X15/6"X6"



# Cross

**Composed of a color palette with earth gray as the protagonist.**

This product is a cross of natural elements that conceptually want to convey the sense of elegance, difference and exceptionality.

We are talking about a fusion between a classic Burgundy Stone with the natural movement of an Onyx marble. Burgundy stone is a limestone from the historic region of central-eastern France, famous for its namesake Burgundy wines. It is an area that is crossed by a network of canals and dotted with large castles, and it is most likely one of the most beautiful regions not only in France but in all of Europe.

**Los colores neutros y pétreos que provienen de la naturaleza.**

Este producto es un cruce de elementos naturales que conceptualmente quieren transmitir el sentido de la elegancia, diferencia y excepcionalidad.

Estamos hablando de una fusión entre una clásica Piedra de Borgoña junto a el movimiento natural de un mármol Ónice. La piedra de Borgoña es una limestone procedente de la región histórica de Francia centro-oriental, famosa por sus homónimos vinos de Borgoña. Es una zona que está atravesada por una red de canales y salpicada de grandes castillos, y es muy probablemente es una de las regiones más bellas no sólo de Francia sino de toda Europa.

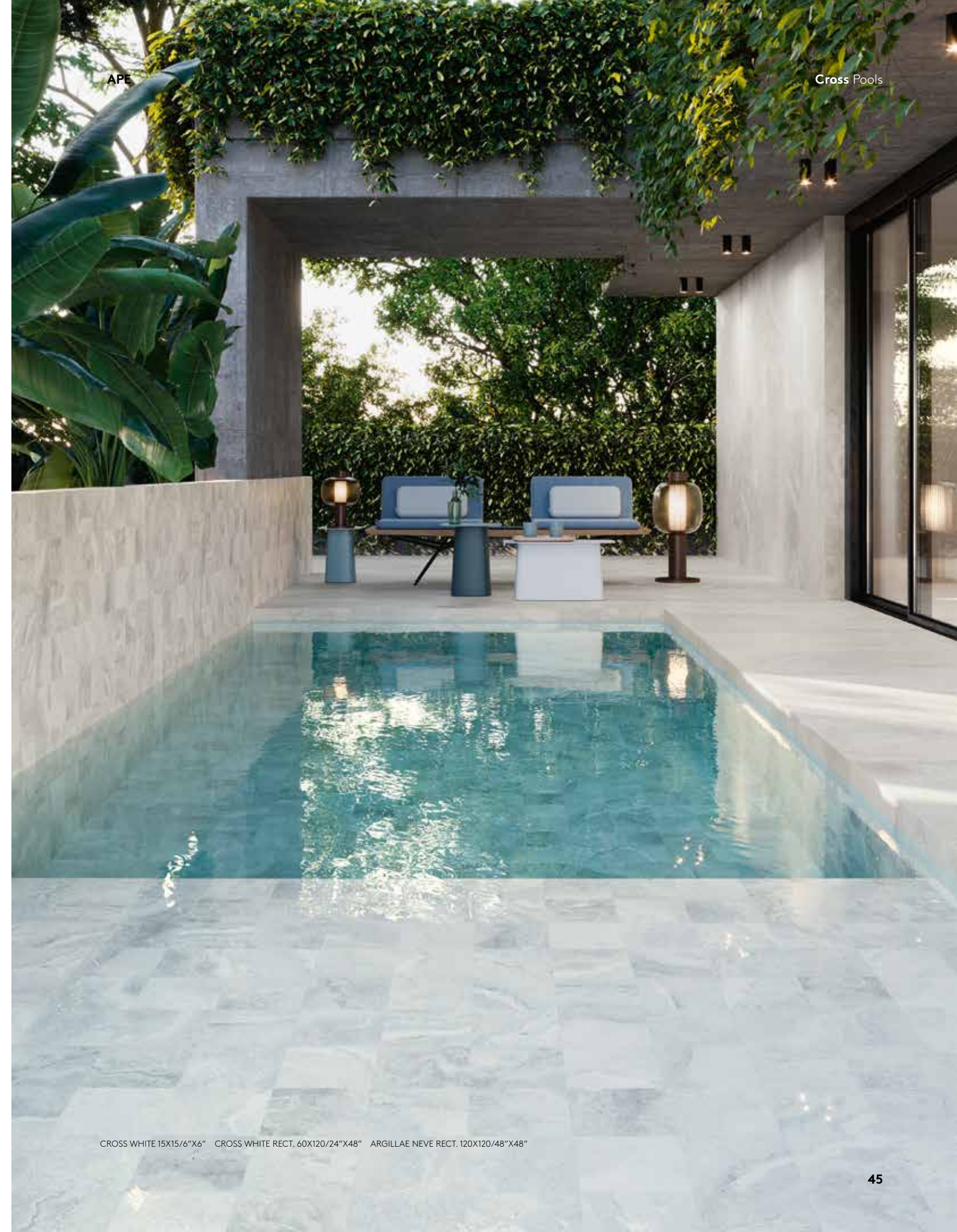



# Cross

APE

Cross Pools



01.



01. PELDAÑO CROSS TAUPE C3 33X33/13"X13"  
CROSS TAUPE 15X15/6"X6" CROSS TAUPE RECT. 60X120/24"X48" ARGILLAE NOCTA RECT. 120X120/48"X48"



# Cross

## PELDAÑO RECTO



PELDAÑO CROSS WHITE C3  
33 X 33 / 13" X 13" K86/P



PELDAÑO CROSS SAND C3  
33 X 33 / 13" X 13" K86/P



PELDAÑO CROSS TAUPE C3  
33 X 33 / 13" X 13" K86/P

### CARACTERÍSTICAS TÉCNICAS · TECHNICAL CHARACTERISTICS

- P** EXTRUSIONADO/EXTRUDED KLINKER
- M** MATE/MATT
- R** RECTIFICADO/RECTIFIED
- V3** VARIACION MODERADA/MODERATE VARIATION
- R11** ANTI-SLIP R11
- A+B+C** ANTI-SLIP BAREFOOT A+B+C
- (DCOF) >0.50**
- C3** CLASE 3/CLASS 3



ROD. CROSS 7,5 X 60 / 3" X 24" K24/P

AVAILABLE IN ALL COLORS / DISPONIBLE EN TODOS LOS COLORES



DORSO ESTRIADO EN COLA DE MILANO.  
DOVE TAIL PROFILE.



JUNTA RECOMENDADA 5 MM.  
RECOMMENDED JOINT BETWEEN PIECES 5 MM.

## BASES



CROSS WHITE  
30X60 / 12"X24" J98/M

**C3 R11** ANTI-SLIP CROSS WHITE  
30X60 / 12"X24" L04 /M



CROSS SAND  
30X60 / 12"X24" J98/M

**C3 R11** ANTI-SLIP CROSS SAND  
30X60 / 12"X24" L04 /M



CROSS TAUPE  
30X60 / 12"X24" J98/M

**C3 R11** ANTI-SLIP CROSS TAUPE  
30X60 / 12"X24" L04 /M



CROSS WHITE  
15X15 / 6"X6" R59/M



CROSS SAND  
15X15 / 6"X6" R59/M



CROSS TAUPE  
15X15 / 6"X6" R59/M

## BASES



CROSS WHITE RECT.  
60X120 / 24"X48" J65/M

**C3 R11** ANTI-SLIP CROSS WHITE RECT.  
60X120 / 24"X48" J66 /M



CROSS SAND RECT.  
60X120 / 24"X48" J65/M

**C3 R11** ANTI-SLIP CROSS SAND RECT.  
60X120 / 24"X48" J66 /M



CROSS TAUPE RECT.  
60X120 / 24"X48" J65/M

**C3 R11** ANTI-SLIP CROSS TAUPE RECT.  
60X120 / 24"X48" J66 /M



CROSS WHITE RECT.  
60X60 / 24"X24" P17/M

**C3 R11** ANTI-SLIP CROSS WHITE RECT.  
60X60 / 24"X24" L03 /M



CROSS SAND RECT.  
60X60 / 24"X24" P17/M

**C3 R11** ANTI-SLIP CROSS SAND RECT.  
60X60 / 24"X24" L03 /M



CROSS TAUPE RECT.  
60X60 / 24"X24" P17/M

**C3 R11** ANTI-SLIP CROSS TAUPE RECT.  
60X60 / 24"X24" L03 /M

### CARACTERÍSTICAS TÉCNICAS · TECHNICAL CHARACTERISTICS

- P** PORCELÁNICO/PORCELAIN TILES
- M** MATE/MATT
- R** RECTIFICADO/RECTIFIED
- V3** VARIACION MODERADA/MODERATE VARIATION
- G** VARIACIÓN DE DISEÑO/GRAPHIC FACES  
60X120- 12 PIEZAS/PIECES  
60X60- 24 PIEZAS/PIECES  
30X60- 48 PIEZAS/PIECES



# Deep Blue

**Deep Blue is a natural stone known as 'Explosion blue', with an incredible charisma.**

**Deep Blue es una piedra natural conocida como 'Explosion blue', con un increíble carisma.**

The sea water reveals before our eyes an extraordinary variety of blues, ranging from dark blue - the classic sea blue - to the turquoise of idyllic white sand beaches. The iconic images of the depths of the sea, coral reefs and Posidonia meadows of the Mediterranean have inspired Deep Blue, a collection by APE Grupo created as a decorative and design element for swimming pools.

El agua del mar despliega ante nuestros ojos una variedad de azules extraordinaria, que va desde el azul oscuro -el clásico azul marino- hasta el turquesa de las playas paradisíacas de arena blanca. Las icónicas imágenes de las profundidades del mar, de los arrecifes de corales y las praderas de posidonia han inspirado Deep Blue, una colección de APE Grupo pensada para exteriores y piscinas.

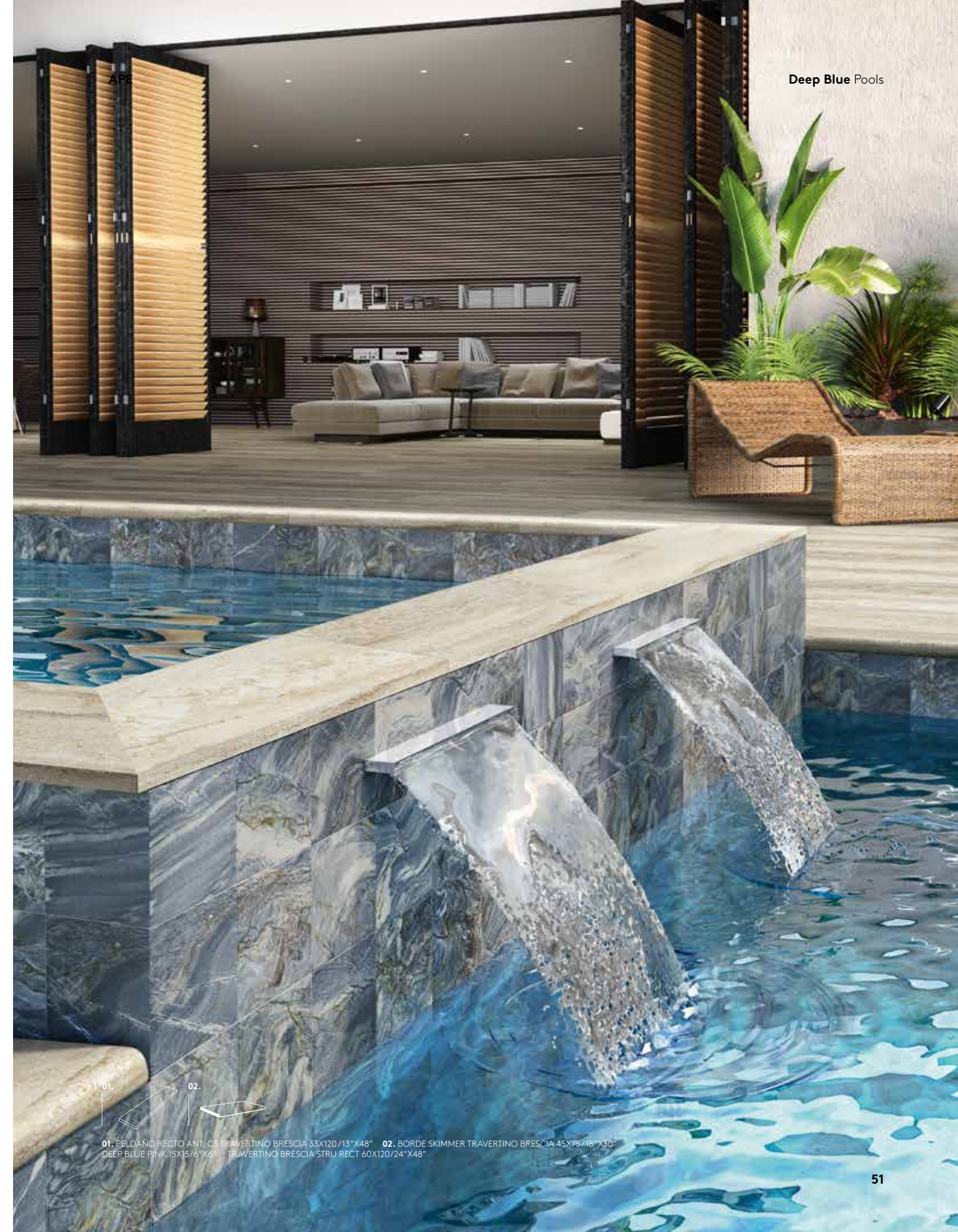

01. Peldaño recto ant. C3 TRAVERTINO BRESCIA 33X120/13"X48" 02. BORDE SKIMMER TRAVERTINO BRESCIA 45X75/18"X30"  
DEEP BLUE PINK 15X15/6"X6" TRAVERTINO BRESCIA STRU RECT 60X120/24"X48"



# Deep Blue

## BASES



DEEP BLUE OXID  
30X60 / 12"X24" J98/M

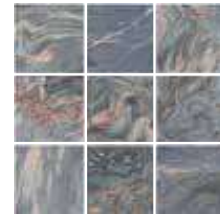

DEEP BLUE PINK  
15X15 / 6"X6" R59/M

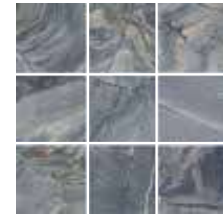

DEEP BLUE OXID  
15X15 / 6"X6" R59/M



### CARACTERÍSTICAS TÉCNICAS · TECHNICAL CHARACTERISTICS



PORCELÁNICO/PORCELAIN TILES



MATE/MATT



VARIACION FUERTE/SUBSTANTIAL VARIATION



ESPESOR/THICKNESS:  
9mm/0,35"



VARIACIÓN DE DISEÑO/GRAPHIC FACES  
30X60- 48 PIEZAS/PIECES  
15X15- 50 PIEZAS/PIECES

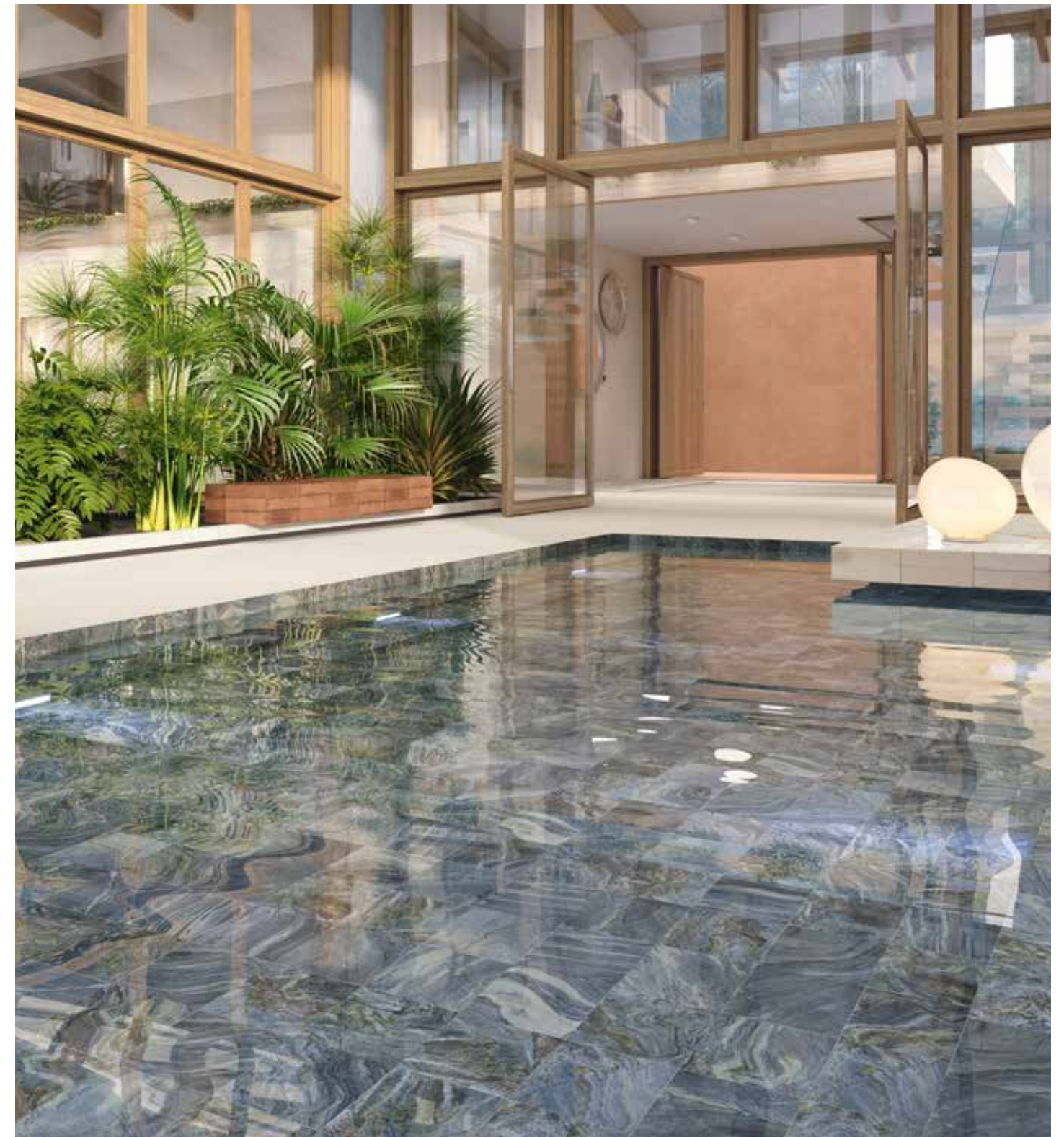



# Illinois

**Stunning and tremendously beautiful designs.**

**Diseños impactantes y tremendamente bellos.**

In the past, cement was only used on the outside of buildings, but over the years, this rough material has conquered spaces and has seeped into the interior of the house giving meaning to the concept 'in-out'. We are, without a doubt, in front of a material, the ceramic cement, immune to the passage of time and with a decorative capacity without limits because it fits perfectly with other materials such as stone or wood.

En otras épocas, el cemento estaba relegado al exterior de las edificaciones, pero, con el paso de los años, este tosco material ha conquistado espacios y se ha colado en el interior de la vivienda para dar sentido al concepto 'in-out'. Estamos, sin duda, ante un material, el cemento cerámico, inmune al paso del tiempo y con una capacidad decorativa sin límites porque encaja a la perfección con otros materiales, como la piedra o la madera.



APE

Illinois Pools

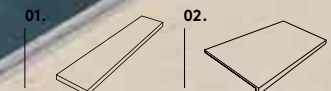

01. ANTI-SLIP ILLINOIS BONE RECT 60X120/24"X48" 02. PELDAÑO RECTO ANT. C3 ILLINOIS BONE 33X120/13"X48"  
ILLINOIS BONE RECT 60X120/24"X48" TRIANA CAOBA RECT 20X120/8"X48" CONTEMPORARY BLUESTONE 15X15/6"X6"



# Illinois

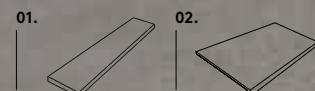

01. ANTI-SLIP ILLINOIS GRAPHITE RECT 60X120/24"X48" 02. PELDAÑO RECTO ANT. C3 ILLINOIS GRAPHITE 33X120/13"X48"  
 ILLINOIS GRAPHITE RECT 100X100/40"X40" DELIGHT BLUE 13,8X13,8/5,5"X5,5"



# Illinois

APE

Illinois Pools

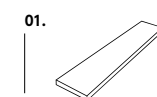

01. ANTI-SLIP ILLINOIS GREY RECT 60X120/24"X48"  
DEEP BLUE OXID 15X15/6"X6"



# Illinois

## BASES



ILLINOIS WHITE RECT.  
100 X 100 / 40"X40" **N23/M**  
**C3 R11** ANTI-SLIP ILLINOIS WHITE RECT.  
100 X 100 / 40"X40" **J97/M**



ILLINOIS BONE RECT.  
100 X 100 / 40"X40" **N23/M**  
**C3 R11** ANTI-SLIP ILLINOIS BONE RECT.  
100 X 100 / 40"X40" **J97/M**



ILLINOIS GREY RECT.  
100 X 100 / 40"X40" **N23/M**  
**C3 R11** ANTI-SLIP ILLINOIS GREY RECT.  
100 X 100 / 40"X40" **J97/M**



ILLINOIS GRAPHITE RECT.  
100 X 100 / 40"X40" **N23/M**  
**C3 R11** ANTI-SLIP ILLINOIS GRAPHITE RECT.  
100 X 100 / 40"X40" **J97/M**

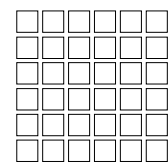

MALLA ILLINOIS  
30X30(5X5)/ 12"X12" **K01/P**

AVAILABLE IN ALL COLORS  
DISPONIBLE EN TODOS LOS COLORES

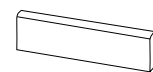

ROD. ILLINOIS  
75 X 100 / 3" X 40" **K17/P**

ROD. ILLINOIS  
75 X 75 / 3" X 30" **K18/P**

ROD. ILLINOIS  
75 X 60 / 3" X 24" **K24/P**

AVAILABLE IN ALL COLORS /  
DISPONIBLE EN TODOS LOS COLORES

### CARACTERÍSTICAS TÉCNICAS · TECHNICAL CHARACTERISTICS

<b>P</b> PORCELÁNICO/PORCELAIN TILES	<b>M</b> MATE/MATT	<b>C2</b> CLASE 2/CLASS 2
<b>R11</b> RECTIFICADO/RECTIFIED	<b>V2</b> VARIACION LEVE/SLIGHT VARIATION	<b>R10</b> VARIACIÓN DE DISEÑO / GRAPHIC FACES
<b>C3</b> MASA COLOREADA/COLORED BODY	<b>+</b> ESPESOR/THICKNESS: 10mm/0,4"	100X100- 9 PIEZAS/PIECES 75X75- 16 PIEZAS/PIECES 60X120- 15 PIEZAS/PIECES 60X60- 30 PIEZAS/PIECES

## BASES

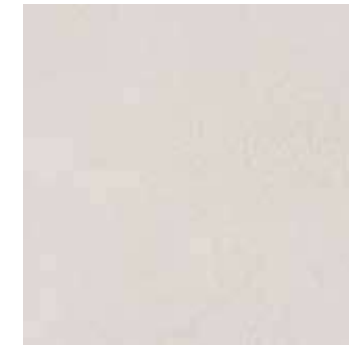

ILLINOIS WHITE RECT.  
75X75 / 30"X30" **J63/M**  
**C3 R11** ANTI-SLIP ILLINOIS WHITE RECT.  
75X75 / 30"X30" **J64/M**

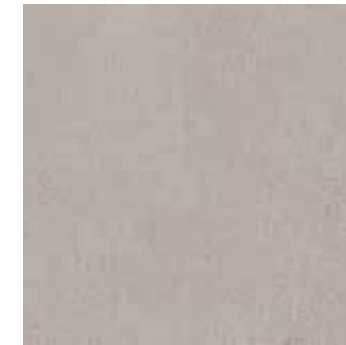

ILLINOIS GREY RECT.  
75X75 / 30"X30" **J63/M**  
**C3 R11** ANTI-SLIP ILLINOIS GREY RECT.  
75X75 / 30"X30" **J64/M**



ILLINOIS GRAPHITE RECT.  
75X75 / 30"X30" **J63/M**  
**C3 R11** ANTI-SLIP ILLINOIS GRAPHITE RECT.  
75X75 / 30"X30" **J64/M**



ILLINOIS BONE RECT.  
75X75 / 30"X30" **J63/M**  
**C3 R11** ANTI-SLIP ILLINOIS BONE RECT.  
75X75 / 30"X30" **J64/M**



ILLINOIS WHITE RECT.  
60X120 / 24"X48" **J65/M**  
**C3 R11** ANTI-SLIP ILLINOIS WHITE RECT.  
60X120 / 24"X48" **J66/M**



ILLINOIS GREY RECT.  
60X120 / 24"X48" **J65/M**  
**C3 R11** ANTI-SLIP ILLINOIS GREY RECT.  
60X120 / 24"X48" **J66/M**



ILLINOIS GRAPHITE RECT.  
60X120 / 24"X48" **J65/M**  
**C3 R11** ANTI-SLIP ILLINOIS GRAPHITE RECT.  
60X120 / 24"X48" **J66/M**



ILLINOIS BONE RECT.  
60X120 / 24"X48" **J65/M**  
**C3 R11** ANTI-SLIP ILLINOIS BONE RECT.  
60X120 / 24"X48" **J66/M**



ILLINOIS WHITE RECT.  
60X60 / 24"X24" **P17/M**



ILLINOIS GREY RECT.  
60X60 / 24"X24" **P17/M**



ILLINOIS GRAPHITE RECT.  
60X60 / 24"X24" **P17/M**



ILLINOIS BONE RECT.  
60X60 / 24"X24" **P17/M**



## PELDAÑO RECTO



**C3** PELDAÑO RECTO ANT. C3 ILLINOIS WHITE  
33 X 120 / 13" X 48" K91/P



**C3** PELDAÑO RECTO ANT. C3 ILLINOIS GREY  
33 X 120 / 13" X 48" K91/P



**C3** PELDAÑO RECTO ANT. C3 ILLINOIS GRAPHITE  
33 X 120 / 13" X 48" K91/P

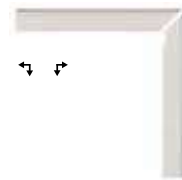

ZANQUIN RECTO DCHA./IZQ. ILLINOIS WHITE  
7,5 X 60 / 3" X 24" K09/P

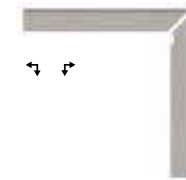

ZANQUIN RECTO DCHA./IZQ. ILLINOIS GREY  
7,5 X 60 / 3" X 24" K09/P

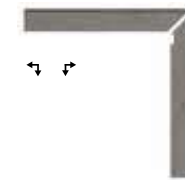

ZANQUIN RECTO DCHA./IZQ. ILLINOIS GRAPHITE  
7,5 X 60 / 3" X 24" K09/P



**C3** PELDAÑO RECTO ANT. C3 ILLINOIS BONE  
33 X 120 / 13" X 48" K91/P

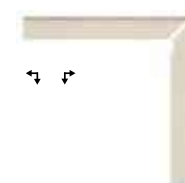

ZANQUIN RECTO DCHA./IZQ. ILLINOIS BONE  
7,5 X 60 / 3" X 24" K09/P

### CARACTERÍSTICAS TÉCNICAS · TECHNICAL CHARACTERISTICS



EXTRUSIONADO/EXTRUDED KLINKER



MATE/MATT



RECTIFICADO/RECTIFIED



VARIACION LEVE/SLIGHT VARIATION



ANTI-SLIP R11



ANTI-SLIP BAREFOOT A+B+C



(DCOF) >0.50



CLASE 3/CLASS 3



DORSO ESTRIADO EN COLA DE MILANO.  
DOVE TAIL PROFILE.



JUNTA RECOMENDADA 5 MM.  
RECOMMENDED JOINT BETWEEN PIECES 5 MM.

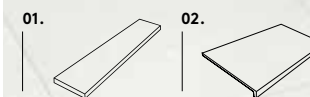
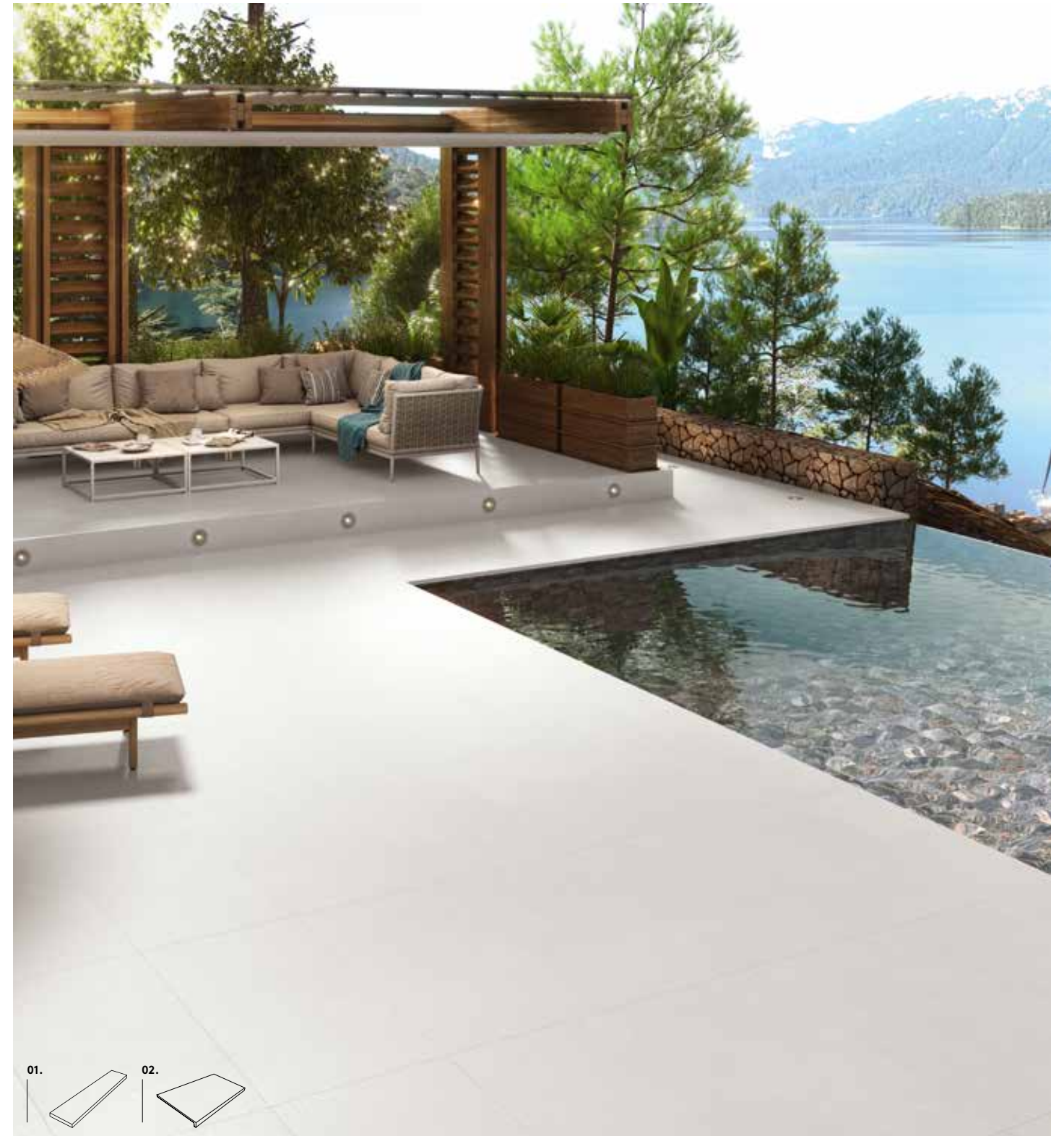

01. ANTI-SLIP ILLINOIS WHITE RECT 60X120/24"X48" 02. PELDAÑO RECTO ANT. C3 ILLINOIS WHITE 33X120/13"X48"  
DEEP BLUE PINK 15X15/6"X6"



# Koen

**Japanese minimalism and Nordic warmth.**

**Minimalismo japonés y calidez nórdica.**

Koen is a proposal for a vast ceramic wood collection capable of solving any challenge of interior design. It is available in multiple formats, and also comes in anti-slip and polished versions and with special pieces such as steps and endings. Therefore, this collection suits any kind of space well. Moreover, we have created decorative pieces inspired in Japan that reproduce the handcrafted work of wood. Koen impresses with its natural result that allows us to enjoy the warmth of wood in any moment and place.

Koen es una apuesta por una colección de madera cerámica amplia que sea capaz de resolver cualquier reto de interiorismo. Cuenta con multitud de formatos, pero también con versiones antislip, pulidas y piezas especiales como peldaños y remates, por lo que es una colección para cualquier tipo de espacio. Además, hemos creado unas piezas decorativas de inspiración nipona que reproduce el trabajo artesano de la madera. Koen impacta por su resultado natural que permite disfrutar de la calidez de la madera en cualquier momento y lugar.



01. ANTI-SLIP KOEN CARAMELLO MATT RECT 20X120/8"X48" 02. PELDAÑO RECTO ANT. C3 KOEN CARAMELLO 33X120/13"X48"



# Koen

APE

Koen Pools

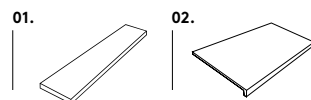

01. ANTI-SLIP KOEN MIELE MATT RECT 20X120/8"X48" 02. PELDAÑO RECTO ANT. C3 KOEN MIELE 33X120/13"X48"



# Koen

## PELDAÑO RECTO



**C3** PELDAÑO RECTO ANT. C3 KOEN CARAMELLO  
33 X 120 / 13" X 48" **K91/P**



**C3** PELDAÑO RECTO ANT. C3 KOEN MIELE  
33 X 120 / 13" X 48" **K91/P**



**C3** PELDAÑO RECTO ANT. C3 KOEN CENERE  
33 X 120 / 13" X 48" **K91/P**



REMATE RECTO PELD. KOEN CARAMELLO  
3.2 X 33 / 1.5" X 13" **K36/P**



REMATE RECTO PELD. KOEN MIELE  
3.2 X 33 / 1.5" X 13" **K36/P**



REMATE RECTO PELD. KOEN CENERE  
3.2 X 33 / 1.5" X 13" **K36/P**



TABICA KOEN CARAMELLO  
15 X 120 / 6" X 48" **K11/P**



TABICA KOEN MIELE  
15 X 120 / 6" X 48" **K11/P**



TABICA KOEN CENERE  
15 X 120 / 6" X 48" **K11/P**



ZANQUIN RECTO DCHA./IZQ. KOEN CARAMELLO  
8 X 60 / 3" X 24" **K09/P**

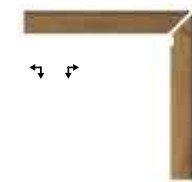



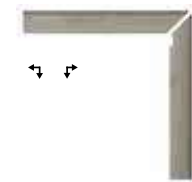





ZANQUIN RECTO DCHA./IZQ. KOEN MIELE  
8 X 60 / 3" X 24" **K09/P**



ZANQUIN RECTO DCHA./IZQ. KOEN CENERE  
8 X 60 / 3" X 24" **K09/P**

### CARACTERÍSTICAS TÉCNICAS TECHNICAL CHARACTERISTICS

-  EXTRUSIONADO/EXTRUDED KLINKER
-  MATE/MATT
-  RECTIFICADO/RECTIFIED
-  VARIACION MODERADA/MODERATE VARIATION
-  ANTI-SLIP R11
-  ANTI-SLIP BAREFOOT A+B+C
-  (DCOF) >0.50
-  CLASE 3/CLASS 3

 DORSO ESTRIADO EN COLA DE MILANO. JUNTA RECOMENDADA 5 MM.  
DOVE TAIL PROFILE. RECOMMENDED JOINT BETWEEN PIECES 5 MM.

## BASES



**M C2 R10** KOEN CARAMELLO MATT RECT  
20 X 120 / 8" X 48" **R52/M**

**M C3 R11** ANTI-SLIP KOEN CARAMELLO MATT RECT  
20 X 120 / 8" X 48" **N72/M**



**M C2 R10** KOEN MIELE MATT RECT  
20 X 120 / 8" X 48" **R52/M**

**M C3 R11** ANTI-SLIP KOEN MIELE MATT RECT  
20 X 120 / 8" X 48" **N72/M**

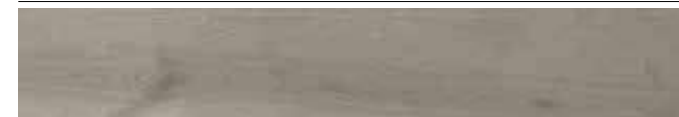

**M C2 R10** KOEN CENERE MATT RECT  
20 X 120 / 8" X 48" **R52/M**

**M C3 R11** ANTI-SLIP KOEN CENERE MATT RECT  
20 X 120 / 8" X 48" **N72/M**



**M C2 R10** KOEN CARAMELLO MATT RECT.  
30 X 120 / 12" X 48" **R52/M**







**M C2 R10** KOEN MIELE MATT RECT.  
30 X 120 / 12" X 48" **R52/M**



ROD. KOEN  
8 X 60 / 3" X 24" **K24/P**

AVAILABLE IN ALL COLORS / DISPONIBLE EN TODOS LOS COLORES

### CARACTERÍSTICAS TÉCNICAS · TECHNICAL CHARACTERISTICS

-  PORCELÁNICO/PORCELAIN TILES
-  RECTIFICADO/RECTIFIED
-  VARIACION MODERADA/MODERATE VARIATION
-  ESPESOR/THICKNESS:  
20X120 - 10mm/0,39"  
30X120 - 10mm/0,39"



# Oregón

**Trendy woods with advanced material properties.**

**Maderas de tendencia con propiedades de materiales avanzados.**

Oregón, an elegant wood that provides the different spaces of the house with warmth and naturalness. Thanks to its anti-slip edge, this collection allows us to enjoy pools with wooden finishes.

With Oregón, it is possible to take finishes such as beech, walnut, oak or wenge to spaces as demanding as a swimming pool without losing one bit of the technical properties of ceramics.

Oregón, una madera elegante que aporta calidez y naturalidad en los diferentes espacios de la vivienda. Gracias a su borde de acabado antideslizante, esta colección permite que podamos disfrutar de piscinas con acabados en madera.

Con Oregón es posible llevar acabados como el haya, el nogal, el roble o el wengué a espacios tan exigentes como una piscina sin perder un ápice de las propiedades técnicas de la cerámica.

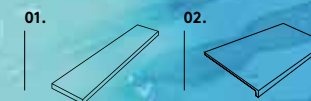

01. ANTI-SLIP OREGÓN NOGAL RECT. 20X120/8\"X48\" 02. PELDAÑO RECTO ANT.C3 OREGON NOGAL 33X120X3/13\"X48\"X1\"



# Oregón

APE

Oregón Pools

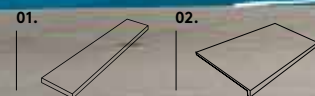

01. ANTI-SLIP OREGÓN GRIS RECT. 20X120/8\"X48\" 02. PELDAÑO RECTO ANT.C3 OREGON GRIS 33X120X3/13\"X48\"X1\"

Visual and tactile wood finish and all the benefits of porcelain and extruded stoneware in resistance, maintenance and anti-slippage.

Acabado visual y táctil de la madera y todas las ventajas del gres porcelánico y extruido en resistencia, mantenimiento y antideslizamiento.

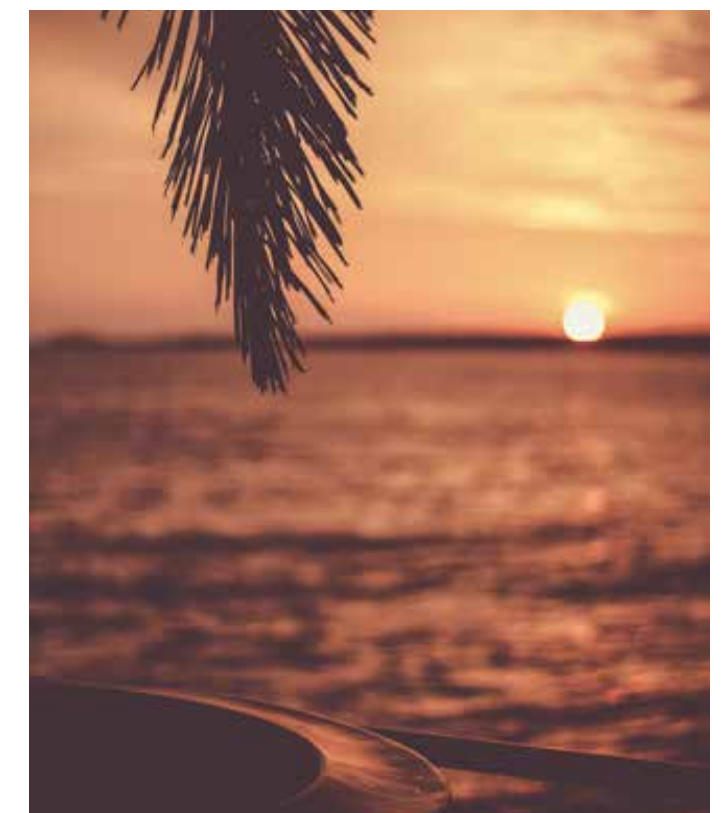



## PELDAÑO RECTO



**C3** PELDAÑO RECTO ANT. C3 OREGON GRIS  
33 X 120 / 13" X 48" **K91/P**



REMATE RECTO PELDAÑO OREGON GRIS  
3.2 X 33 / 1.5" X 13" **K36/P**



TABICA OREGON GRIS  
15 X 120 / 6" X 48" **K11/P**



ZANQUIN RECTO DCHA./ IZQ. OREGON GRIS  
8 X 60 / 3" X 24" **K09/P**



**C3** PELDAÑO RECTO ANT. C3 OREGON NOGAL  
33 X 120 / 13" X 48" **K91/P**



REMATE RECTO PELDAÑO OREGON NOGAL  
3.2 X 33 / 1.5" X 13" **K36/P**



TABICA OREGON NOGAL  
15 X 120 / 6" X 48" **K11/P**

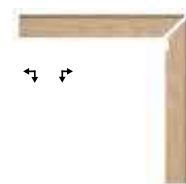

ZANQUIN RECTO DCHA./ IZQ. OREGON NOGAL  
8 X 60 / 3" X 24" **K09/P**



**C3** PELDAÑO RECTO ANT. C3 OREGON ROBLE  
33 X 120 / 13" X 48" **K91/P**



REMATE RECTO PELDAÑO OREGON ROBLE  
3.2 X 33 / 1.5" X 13" **K36/P**



TABICA OREGON ROBLE  
15 X 120 / 6" X 48" **K11/P**

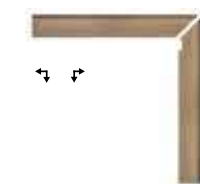

ZANQUIN RECTO DCHA./ IZQ. OREGON ROBLE  
8 X 60 / 3" X 24" **K09/P**

### CARACTERÍSTICAS TÉCNICAS · TECHNICAL CHARACTERISTICS

- E** EXTRUSIONADO/EXTRUDED KLINKER
- M** MATE/MATT
- V2** VARIACION LEVE/SLIGHT VARIATION
- R** RECTIFICADO/RECTIFIED
- R11** ANTI-SLIP R11
- (DCOF) >0.50**
- C3** CLASE 3/CLASS 3
- A+B+C** ANTI-SLIP BAREFOOT A+B+C



DORSO ESTRIADO EN COLA DE MILANO.  
DOVE TAIL PROFILE.



JUNTA RECOMENDADA 5 MM.  
RECOMMENDED JOINT BETWEEN PIECES 5 MM.

## BASES



OREGON GRIS RECT  
20 X 120 / 8" X 48" **R52/M**

**C3 R11** ANTI-SLIP OREGON GRIS RECT  
20 X 120 / 8" X 48" **N72/M**



OREGON NOGAL RECT  
20 X 120 / 8" X 48" **R52/M**

**C3 R11** ANTI-SLIP OREGON NOGAL RECT  
20 X 120 / 8" X 48" **N72/M**



OREGON ROBLE RECT  
20 X 120 / 8" X 48" **R52/M**

**C3 R11** ANTI-SLIP OREGON ROBLE RECT  
20 X 120 / 8" X 48" **N72/M**



ROD. OREGON  
8 X 60 / 3" X 24" **K24/P**

AVAILABLE IN ALL COLORS / DISPONIBLE EN TODOS LOS COLORES

### CARACTERÍSTICAS TÉCNICAS · TECHNICAL CHARACTERISTICS

- P** PORCELÁNICO/PORCELAIN TILES
- M** MATE/MATT
- R** RECTIFICADO/RECTIFIED
- V2** VARIACION LEVE/SLIGHT VARIATION
- T** ESPESOR/THICKNESS:  
20X120 - 10mm/0,39"



# Oxford

**Oxford collection is inspired in concrete materials.**

**La colección Oxford se inspira en materiales cementosos.**

This collection will allow you to feel the smooth touch of water on your skin. Be relaxed. Be comfortable.

Enjoy the swimming pool in the coziness of your home, close to what you love the most, your family, your belongings. A space constructed to integrate into any architecture by its nature. It is highly durable and resistant and has an anti-slip surface, and is softer and more durable thanks to the absence of exaggerated reliefs.

With Oxford ceramics, you will have a different pool, a unique space, your own paradise without giving up a single minute of your free time.

It is so functional and practical that it allows you to personalize the design, shape, colors and every detail. The different ceramic pieces adapt both to the swimming pool tank and its perimeter.

La colección Oxford se presenta para hacerte sentir el suave contacto del agua en tu piel. Estar relajado. Estar cómodo.

Disfrutar de la piscina en la comodidad de tu hogar, cerca de lo que más quieres, tu familia, tus cosas... Un espacio construido para integrarse en cualquier arquitectura por su carácter natural, de alta durabilidad, resistencia y con una superficie antideslizante suave y más duradera por la ausencia de relieves exagerados.

Con la cerámica Oxford tendrás una piscina diferente, un espacio único, tu propio paraíso particular, sin tener que renunciar ni siquiera a un minuto de tu tiempo libre.

Es tan funcional y práctica que permite personalizar el diseño, la forma, los colores y todos sus detalles. Las diferentes piezas cerámicas se adaptan tanto al vaso de la piscina como a la zona de playa.

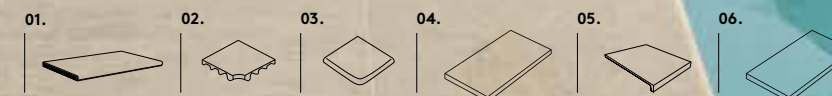

01. BORDE PISCINA OXFORD PURE 28X66,5/11"X26" 02. ÁNGULO INTERIOR PISCINA OXFORD PURE 33X33/13"X13" 03. ÁNGULO PISCINA INGLETADO EXT.OXFORD PURE 28X28/11"X11"  
04. OXFORD C3 PURE 33X66,5/13"X26" 05. PELDAÑO RECTO OXFORD PURE 33X33X3/13"X13"X1" 06. OXFORD C1 PURE 33X66,5/13"X26"



# Oxford

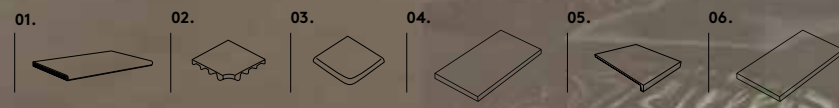

01. BORDE PISCINA OXFORD ASHEN 28X66,5/11"X26" 02. ÁNGULO INTERIOR PISCINA OXFORD ASHEN 33X33/13"X13" 03. ÁNGULO PISCINA INGLETADO EXT.OXFORD ASHEN 28X28/11"X11"  
04. OXFORD C3 ASHEN 33X66,5/13"X26" 05. PELDAÑO RECTO OXFORD ASHEN 33X33X3/13"X13"X1" 06. OXFORD C1 ASHEN 33X66,5/13"X26"



01. BORDE PISCINA OXFORD SLATE 28X66,5/11"X26" 02. ÁNGULO INTERIOR PISCINA OXFORD SLATE 33X33/13"X13" 03. OXFORD C3 SLATE 33X66,5/13"X26"  
04. PELDAÑO RECTO OXFORD SLATE 33X33X3/13"X13"X1" 05. OXFORD C1 SLATE 33X66,5/13"X26"



# Oxford



01. OXFORD C3 PURE 33X66,5/13"X26" 02. BORDE DESBORDANTE OXFORD PURE 28X66,5/11"X26"  
 03. REJILLA OXFORD PURE 24,5X24,5/9,4"X9,4" 04. PELDAÑO RECTO OXFORD PURE 33X33/13"X13" 05. OXFORD C1 PURE 33X66,5/13"X26"



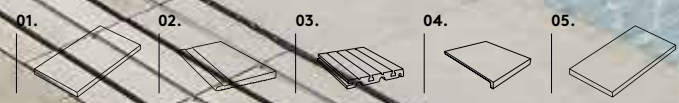

01. OXFORD C3 PURE 33X66,5/13"X26" 02. BORDE DESBORDANTE OXFORD PURE 28X66,5/11"X26"  
 03. REJILLA OXFORD PURE 24,5X24,5X9,4"X9,4" 04. PELDANO RECTO OXFORD PURE 33X33/13"X13" 05. OXFORD C1 PURE 33X66,5/13"X26"

Overflow pools are irresistible. Water is at the same level as the edge, creating a spectacular lake effect.

Las piscinas desbordantes son irresistibles. En ellas el agua está al mismo nivel que el borde, así se crea un espectacular efecto lago.





## TRADITIONAL POOL / PISCINA TRADICIONAL



BORDE PISCINA OXFORD PURE  
28 X 66.5 / 11" X 26" **K94/P**



BORDE PISCINA OXFORD ASHEN  
28 X 66.5 / 11" X 26" **K94/P**



BORDE PISCINA OXFORD NEUTRAL  
28 X 66.5 / 11" X 26" **K94/P**



BORDE PISCINA OXFORD SLATE  
28 X 66.5 / 11" X 26" **K94/P**



ANGULO PISCINA INGLETADO EXT. OXFORD PURE  
28 X 28 / 11" X 11" **K39/P**



ANGULO PISCINA INGLETADO EXT. OXFORD ASHEN  
28 X 28 / 11" X 11" **K39/P**



ANGULO PISCINA INGLETADO EXT. OXFORD NEUTRAL  
28 X 28 / 11" X 11" **K39/P**



ANGULO PISCINA INGLETADO EXT. OXFORD SLATE  
28 X 28 / 11" X 11" **K39/P**



ANGULO PISCINA INT. OXFORD PURE  
33 X 33 / 13" X 13" **K39/P**



ANGULO PISCINA INT. OXFORD ASHEN  
33 X 33 / 13" X 13" **K39/P**



ANGULO PISCINA INT. OXFORD NEUTRAL  
33 X 33 / 13" X 13" **K39/P**



ANGULO PISCINA INT. OXFORD SLATE  
33 X 33 / 13" X 13" **K39/P**



REF. 222 MEDIA CAÑA OXFORD PURE  
4 X 33 / 1.5" X 13" **K29/P**



REF. 222 MEDIA CAÑA OXFORD ASHEN  
4 X 33 / 1.5" X 13" **K29/P**



REF. 222 MEDIA CAÑA OXFORD NEUTRAL  
4 X 33 / 1.5" X 13" **K29/P**



REF. 222 MEDIA CAÑA OXFORD SLATE  
4 X 33 / 1.5" X 13" **K29/P**



REF. 232 UÑA OXFORD PURE  
4 X 4 / 1.5" X 1.5" **K06/P**



REF. 232 UÑA OXFORD ASHEN  
4 X 4 / 1.5" X 1.5" **K06/P**



REF. 232 UÑA OXFORD NEUTRAL  
4 X 4 / 1.5" X 1.5" **K06/P**



REF. 232 UÑA OXFORD SLATE  
4 X 4 / 1.5" X 1.5" **K06/P**

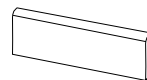

RODAPIE OXFORD  
9 X 33 / 3.5" X 13" **K34/P**

AVAILABLE IN ALL COLORS / DISPONIBLE EN TODOS LOS COLORES

### CARACTERÍSTICAS TÉCNICAS · TECHNICAL CHARACTERISTICS



EXTRUSIONADO/EXTRUDED KLINKER



ANTI-SLIP R11



MATE/MATT



(DCOF) >0.50



VARIACION FUERTE/SUBSTANTIAL VARIATION



CLASE 3 / CLASS 3



ANTI-SLIP BAREFOOT A+B+C



MEDIA CAÑA  
4X33 / 1.5"X13"



DORSO ESTRIADO EN COLA DE MILANO.  
DOVE TAIL PROFILE.



JUNTA RECOMENDADA 5 MM.  
RECOMMENDED JOINT BETWEEN PIECES 5 MM.

## OVERFLOW POOL / PISCINA DESBORDANTE



BORDE DESBORDANTE OXFORD PURE  
28 X 66.5 / 11" X 26" **K94/P**



BORDE DESBORDANTE OXFORD ASHEN  
28 X 66.5 / 11" X 26" **K94/P**



BORDE DESBORDANTE OXFORD NEUTRAL  
28 X 66.5 / 11" X 26" **K94/P**



BORDE DESBORDANTE OXFORD SLATE  
28 X 66.5 / 11" X 26" **K94/P**



REJILLA OXFORD PURE  
24,5 X 24.5 / 9.4" X 9.4" **K57/P**



REJILLA OXFORD ASHEN  
24,5 X 24.5 / 9.4" X 9.4" **K57/P**



REJILLA OXFORD NEUTRAL  
24,5 X 24.5 / 9.4" X 9.4" **K57/P**



REJILLA OXFORD SLATE  
24,5 X 24.5 / 9.4" X 9.4" **K57/P**

## PELDAÑO RECTO



CARTABON RECTO INGLETADO OXFORD PURE  
33 X 33 / 13" X 13" **K78/P**



CARTABON RECTO INGLETADO OXFORD ASHEN  
33 X 33 / 13" X 13" **K78/P**



CARTABON RECTO INGLETADO OXFORD NEUTRAL  
33 X 33 / 13" X 13" **K78/P**



CARTABON RECTO INGLETADO OXFORD SLATE  
33 X 33 / 13" X 13" **K78/P**



PELDAÑO RECTO OXFORD C3 PURE  
33 X 33 / 13" X 13" **K86/P**



PELDAÑO RECTO OXFORD C3 ASHEN  
33 X 33 / 13" X 13" **K86/P**



PELDAÑO RECTO OXFORD C3 NEUTRAL  
33 X 33 / 13" X 13" **K86/P**



PELDAÑO RECTO OXFORD C3 SLATE  
33 X 33 / 13" X 13" **K86/P**

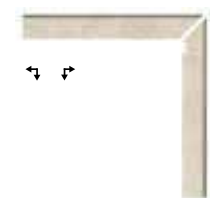

ZANQUIN RECTO OXFORD DCHO./IZQ PURE  
41 X 17.5 / 16" X 7" **K02/P**



ZANQUIN RECTO OXFORD DCHO./IZQ ASHEN  
41 X 17.5 / 16" X 7" **K02/P**

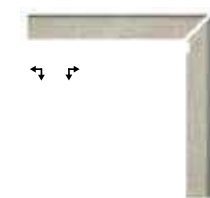

ZANQUIN RECTO OXFORD DCHO./IZQ NEUTRAL  
41 X 17.5 / 16" X 7" **K02/P**

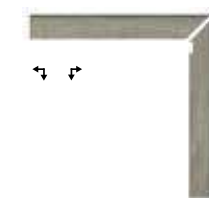

ZANQUIN RECTO OXFORD DCHO./IZQ SLATE  
41 X 17.5 / 16" X 7" **K02/P**



TABICA OXFORD PURE  
15 X 33 / 6" X 13" **K11/P**



TABICA OXFORD ASHEN  
15 X 33 / 6" X 13" **K11/P**



TABICA OXFORD NEUTRAL  
15 X 33 / 6" X 13" **K11/P**



TABICA OXFORD SLATE  
15 X 33 / 6" X 13" **K11/P**



# Oxford

## BASES



OXFORD PURE C1  
33 X 66.5 / 13" X 26"

R48/M

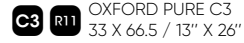

OXFORD PURE C3  
33 X 66.5 / 13" X 26"

R48/M



OXFORD NEUTRAL C1  
33 X 66.5 / 13" X 26"

R48/M

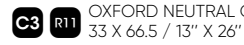

OXFORD NEUTRAL C3  
33 X 66.5 / 13" X 26"

R48/M



OXFORD ASHEN C1  
33 X 66.5 / 13" X 26"

R48/M

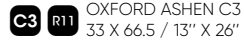

OXFORD ASHEN C3  
33 X 66.5 / 13" X 26"

R48/M



OXFORD SLATE C1  
33 X 66.5 / 13" X 26"

R48/M

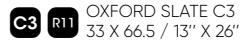

OXFORD SLATE C3  
33 X 66.5 / 13" X 26"

R48/M

### CARACTERÍSTICAS TÉCNICAS · TECHNICAL CHARACTERISTICS

**P** PORCELÁNICO/PORCELAIN TILES

**M** MATE/MATT

**V4** VARIACION FUERTE/SUBSTANTIAL VARIATION

**T** ESPESOR/THICKNESS:  
33X66 - 10mm/0,39"

**C1** CLASE 1/CLASS 1 (DISPONIBLE EN TODOS LOS COLORES / AVAILABLE IN ALL COLORS)

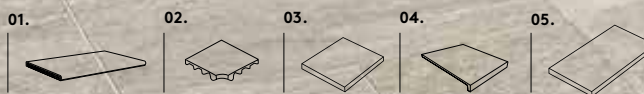

01. BORDE PISCINA OXFORD NEUTRAL 28X66,5/11"X26" 02. ÁNGULO INTERIOR PISCINA OXFORD NEUTRAL 33X33/13"X13"  
03. OXFORD C3 NEUTRAL 33X66,5/13"X26" 04. PELDAÑO RECTO OXFORD NEUTRAL 33X33X3/13"X13"X1" 05. OXFORD C1 NEUTRAL 33X66,5/13"X26"



# Pierre de Bali

Elegant and exotic.

Elegante y exótica.

Pierre de Bali recreates an original stone from this serene island in Southeast Asia and helps us feel at one with nature, giving any space in our home its own identity. Elegant and exotic, this collection has a specific series for outdoors and pools.

Pierre de Bali reproduce una piedra original de la isla del sudeste asiático que aporta serenidad y nos ayuda a integrarnos con la naturaleza, dotando a cualquier zona de nuestro hogar de identidad propia. Elegante y exótica, esta colección tiene una serie específica para exteriores y piscina.

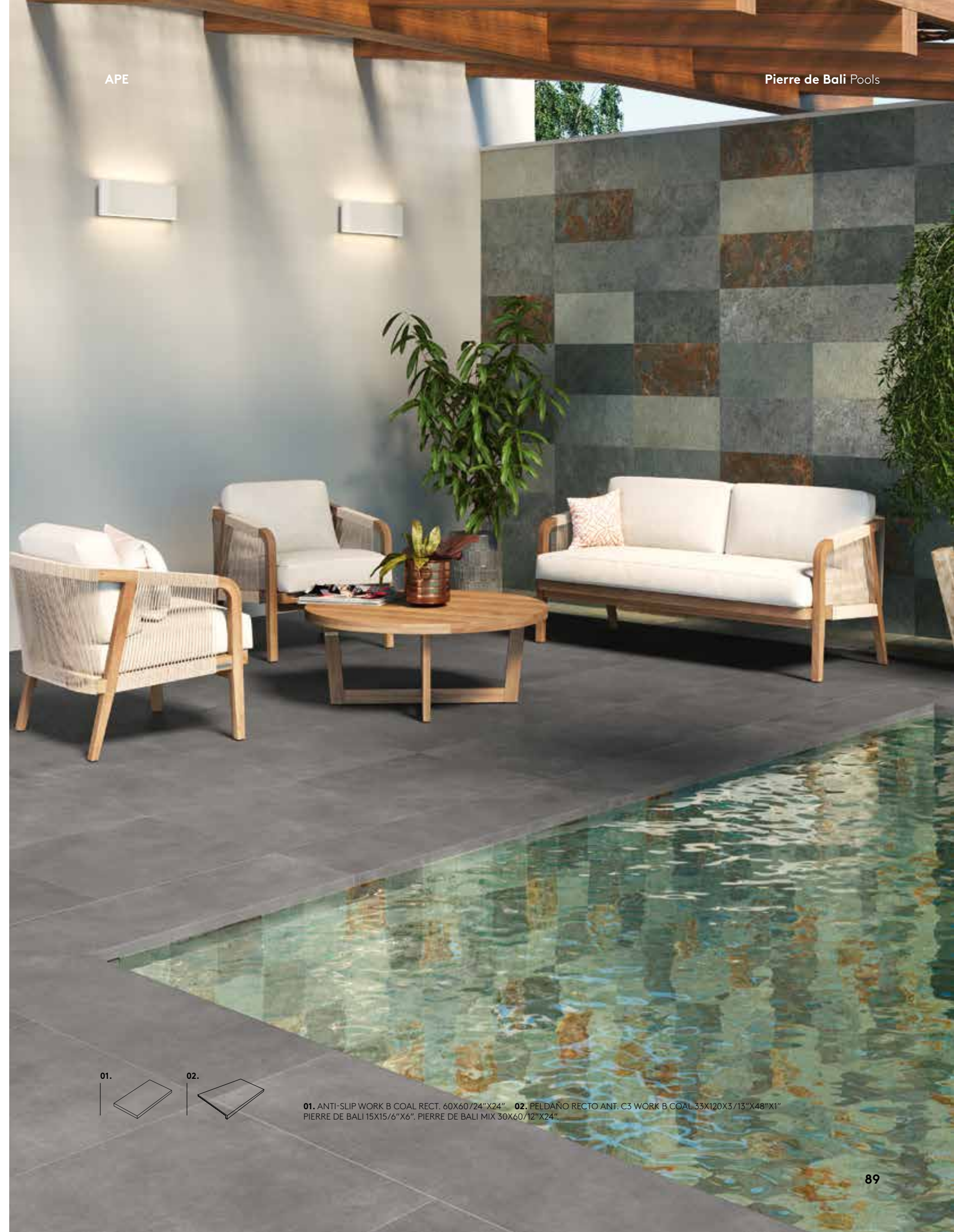

01.



02.



01. ANTI-SLIP WORK B COAL RECT. 60X60/24"X24" 02. PELDAÑO RECTO ANT. C3 WORK B COAL 33X120X3/13"X48"X1"  
PIERRE DE BALI 15X15/6"X6" PIERRE DE BALI MIX 30X60/12"X24"



# Pierre de Bali

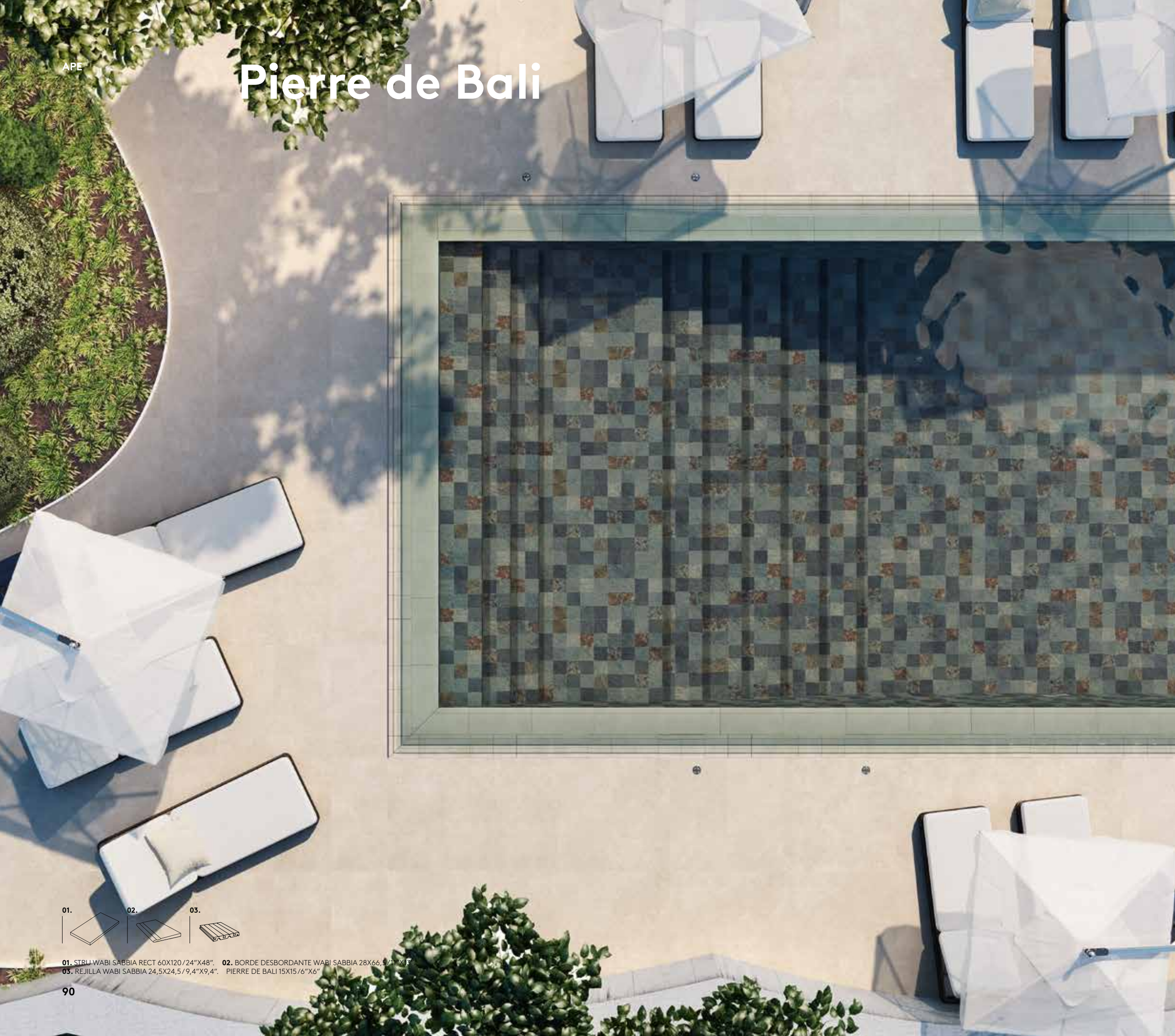

Famous for its lush volcanic mountains, iconic rice paddies, stunning beaches and coral reefs, Bali is one of Indonesia's most popular islands.

Conocida por sus frondosas montañas volcánicas, además de por los icónicos arrozales, las playas y los arrecifes de coral, Bali da nombre a una de las islas más turísticas de Indonesia.



01. STU WABI SABBIA RECT 60X120/24"X48". 02. BORDE DESBORDANTE WABI SABBIA 28X66,5/11"X26". 03. REJILLA WABI SABBIA 24,5X24,5/9,4"X9,4". PIERRE DE BALI 15X15/6"X6"



# Pierre de Bali

APE

Pierre de Bali Pools



## BASES



PIERRE DE BALI MIX  
30X60 / 12"X24" J27/M

**C3 R11** ANTI-SLIP PIERRE DE BALI MIX  
30X60 / 12"X24" N79/M



PIERRE DE BALI  
15X15 / 6"X6" R59/M



PELDAÑO RECTO PIERRE DE BALI C3  
33X33 / 13"X13" K86/P

- P** EXTRUSIONADO/EXTRUDED KLINKER
- C3** CLASE 3/CLASS 3
- R11** ANTI-SLIP BAREFOOT A+B+C

## CARACTERÍSTICAS TÉCNICAS · TECHNICAL CHARACTERISTICS

- P** PORCELÁNICO/PORCELAIN TILES
- M** MATE/MATT
- V4** VARIACION FUERTE/SUBSTANTIAL VARIATION
- 8mm** ESPESOR 8MM/THICKNESS 0,3"
- 30x60** VARIACIÓN DE DISEÑO / GRAPHIC FACES  
30X60 - 42 PIEZAS/42 PIECES  
15X15 - 50 PIEZAS/50 PIECES

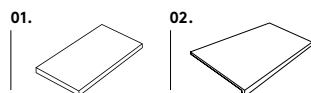

01. PIERRE DE BALI 15X15/6"X6" 02. PELDAÑO RECTO PIERRE DE BALI C3 33X33/13"X13"



# Triana

**The music can be felt in each of its lines. You can hear it; you can feel it.**

**La música se siente en cada una de sus líneas. Puedes escucharla; puedes sentirla.**

Triana, in Seville, has traditionally been an area of sailors, workers, potters and manufacturers. It is also flamenco, music and art. The guitar and ceramics have shared prominence in the streets of this district.

The history of Triana has inspired a wood collection that takes into consideration every detail, such as the craftsmen who make Spanish guitars in the small workshops of Seville or the Flamenco artists who caress the strings of this instrument.

Triana, en Sevilla, ha sido tradicionalmente una zona de marineros, obreros, alfareros e industriales. También es flamenco, música y arte. La guitarra y la cerámica han compartido protagonismo en las calles de este barrio. La historia de Triana ha inspirado una colección de maderas que cuida con mimo cada detalle, como el de los artesanos que fabrican las guitarras españolas en pequeños talleres de Sevilla o el de los flamencos cuando acarician las cuerdas de este instrumento.

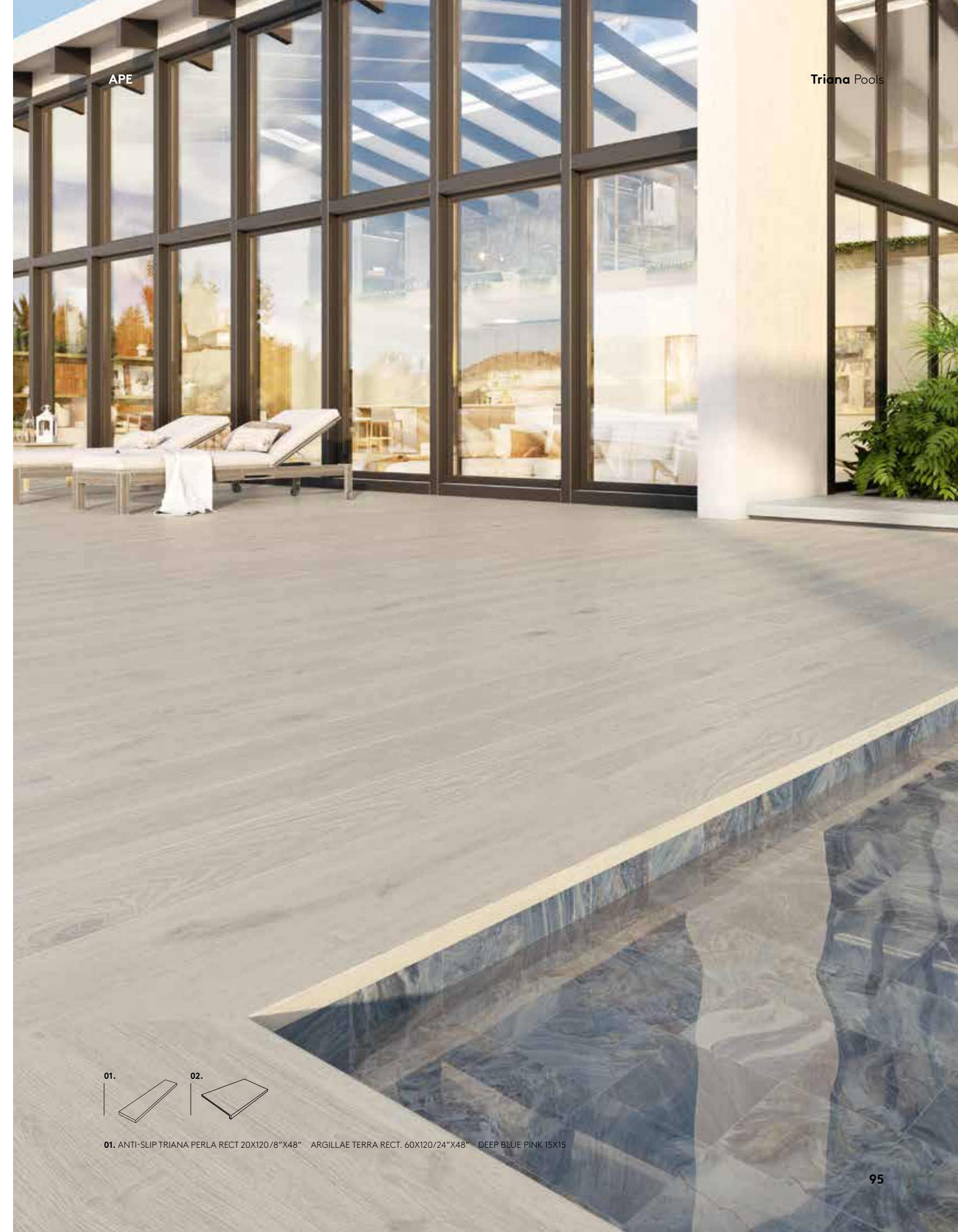

01.



02.

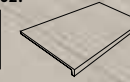

01. ANTI-SLIP TRIANA PERLA RECT 20X120/8"X48" ARGILLAE TERRA RECT. 60X120/24"X48" DEEP BLUE PINK 15X15



## PELDAÑO RECTO



**C3** PELDAÑO RECTO ANT. C3 TRIANA HAYA  
33 X 120 / 13" X 48" K91/P



**C3** PELDAÑO RECTO ANT. C3 TRIANA DESIERTO  
33 X 120 / 13" X 48" K91/P



**C3** PELDAÑO RECTO ANT. C3 TRIANA CAOBA  
33 X 120 / 13" X 48" K91/P



TABICA TRIANA HAYA  
15 X 120 / 6" X 48" K11/P



TABICA TRIANA DESIERTO  
15 X 120 / 6" X 48" K11/P



TABICA TRIANA CAOBA  
15 X 120 / 6" X 48" K11/P

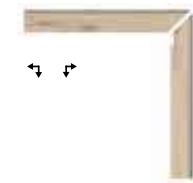

ZANQUIN RECTO DCHA./IZQ. TRIANA HAYA  
10 X 60 / 4" X 24" K09/P

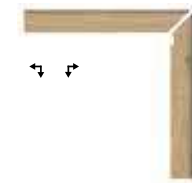

ZANQUIN RECTO DCHA./IZQ. TRIANA DESIERTO  
10 X 60 / 4" X 24" K09/P

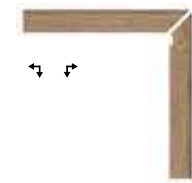

ZANQUIN RECTO DCHA./IZQ. TRIANA CAOBA  
10 X 60 / 4" X 24" K09/P



**C3** PELDAÑO RECTO ANT. C3 TRIANA PERLA  
33 X 120 / 13" X 48" K91/P





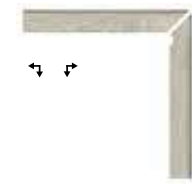





TABICA TRIANA PERLA  
15 X 120 / 6" X 48" K11/P



ZANQUIN RECTO DCHA./IZQ. TRIANA PERLA  
10 X 60 / 4" X 24" K09/P

### CARACTERÍSTICAS TÉCNICAS TECHNICAL CHARACTERISTICS

-  EXTRUSIONADO/EXTRUDED KLINKER
-  MATE/MATT
-  RECTIFICADO/RECTIFIED
-  VARIACION MODERADA/MODERATE VARIATION
-  ANTI-SLIP R11
-  ANTI-SLIP BAREFOOT A+B+C
-  (DCOF) >0.50
-  CLASE 3/CLASS 3

 DORSO ESTRIADO EN COLA DE MILANO. JUNTA RECOMENDADA 5 MM.  
DOVE TAIL PROFILE. RECOMMENDED JOINT BETWEEN PIECES 5 MM.

## BASES



TRIANA HAYA RECT  
20X120 / 8"X48" R52/M

**C3 R11** ANTI-SLIP TRIANA HAYA RECT  
20X120 / 8"X48" N72/M



TRIANA DESIERTO RECT  
20X120 / 8"X48" R52/M

**C3 R11** ANTI-SLIP TRIANA DESIERTO RECT  
20X120 / 8"X48" N72/M



TRIANA CAOBA RECT  
20X120 / 8"X48" R52/M

**C3 R11** ANTI-SLIP TRIANA CAOBA RECT  
20X120 / 8"X48" N72/M



TRIANA PERLA RECT  
20X120 / 8"X48" R52/M

**C3 R11** ANTI-SLIP TRIANA PERLA RECT  
20X120 / 8"X48" N72/M



TRIANA CENIZA RECT  
20X120 / 8"X48" R52/M









TRIANA CANELA RECT  
20X120 / 8"X48" R52/M



ROD. TRIANA  
10 X 120 / 4" X 48" K02/P

AVAILABLE IN ALL COLORS / DISPONIBLE EN TODOS LOS COLORES

### CARACTERÍSTICAS TÉCNICAS · TECHNICAL CHARACTERISTICS

-  PORCELÁNICO/PORCELAIN TILES
-  MATE/MATT
-  RECTIFICADO/RECTIFIED
-  VARIACION MODERADA/MODERATE VARIATION
-  ESPESOR/THICKNESS:  
20X120 - 10mm/0,4"
-  VARIACIÓN DE DISEÑO/GRAPHIC FACES: 18 PIEZAS/PIECES



# Vita

**Ceramic white marble design for exterior swimming pools.**

**Mármol blanco cerámico diseñado para piscinas exteriores.**

The Vita series is inspired in white marble and appears to be the ideal option for the inside, the outside, and swimming pools. Given its finishes in Class 1 and Class 3, this series achieves an aesthetic continuity between the inside and the outside of the house, including the swimming pool, with suitable technical attributes and a unique design. Vita is the perfect solution for the traditional pools.

La serie Vita está inspirada en mármol blanco y se presenta como la opción ideal para interiores, exteriores y piscinas. Los acabados en Clase 1 y Clase 3 permiten que esta serie logre una continuidad estética entre el interior y el exterior de la vivienda, incluyendo la piscina, con características técnicas apropiadas y un diseño único. Vita es la solución perfecta para las piscinas tradicionales.

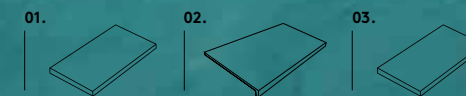

01. NUOVA STRU RECT. 60X120/24"X48" 02. PELDAÑO RECTO NUOVA 33X120X3/13"X48"X1" 03. LUCE MATT RECT. 60X120/24"X48"



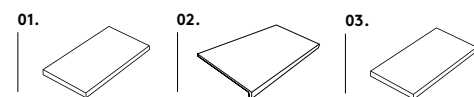

01. NUOVA STRU RECT. 60X120/24"X48" 02. PELDAÑO RECTO NUOVA 33X120X3/13"X48"X1" 03. LUCE MATT RECT. 60X120/24"X48"



# Vita

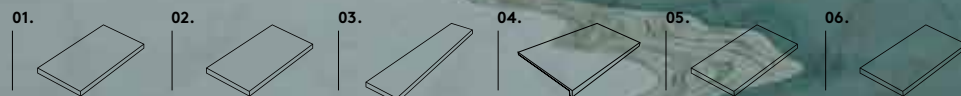

01. NUOVA STRU RECT. 60X120/24"X48" 02. NUOVA STRU RECT. 30X60/12"X24"  
 03. ANTI-SLIP ALABAMA SÁDALO RECT. 20X120/8"X48" 04. PELDAÑO RECTO ANT. C3 ALABAMA SÁDALO 33X120X3/13"X48"X1" 05. LUCE MATT RECT. 60X120/24"X48" 06. LUCE MATT RECT. 30X60/12"X24"



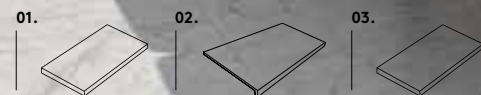

01. NUOVA STRU RECT. 60X120/24"X48" 02. PELDAÑO RECTO NUOVA 33X120X3/13"X48"X1" 03. LUCE MATT RECT. 60X120/24"X48"

It improves the aesthetics of the whole space, both in interior and exterior projects, and the space surrounding the swimming pool is flaunted more intensely.

Mejora la estética de todo el espacio, tanto en proyectos de exterior como de interior, todo el espacio que rodea la piscina luce con más fuerza.





## PELDAÑO RECTO

## BASES



PELDAÑO RECTO NUOVA  
33 X 120 / 13" X 48" **K91/P**



REMATE RECTO PELDAÑO NUOVA  
3.2 X 33 / 1.5" X 13" **K36/P**

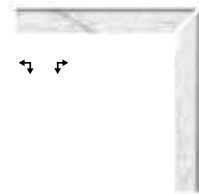

ZANQUIN RECTO DCHA./IZQ. NUOVA STRU  
7,5X60/3"X24" **K09/P**



TABICA NUOVA  
15 X 120 / 6" X 48" **K11/P**



DORSO ESTRIADO EN COLA DE MILANO.  
DOVE TAIL PROFILE.



JUNTA RECOMENDADA 5 MM.  
RECOMMENDED JOINT BETWEEN PIECES 5 MM.

### CARACTERÍSTICAS TÉCNICAS - TECHNICAL CHARACTERISTICS

- N** EXTRUSIONADO/EXTRUDED KLINKER
- M** MATE/MATT
- V2** VARIACION LEVE/SLIGHT VARIATION
- R11** ANTI-SLIP R11
- (DCOF) >0.50**
- C3** CLASE 3/CLASS 3
- ANTI-SLIP BAREFOOT A+B+C**



**M C3 R11** NUOVA STRU RECT  
60 X 120 / 24" X 48" **N74/M**



**M C3 R11** NUOVA STRU RECT.  
60 X 60 / 24" X 24" **N33/M**



**M C3 R11** NUOVA STRU RECT.  
30 X 60 / 12" X 24" **N33/M**



**M** LUCE MATT RECT  
120 X 120 / 48" X 48" **N31/M**

**M C2** LUCE C2 RECT  
120 X 120 / 48" X 48" **N34/M**

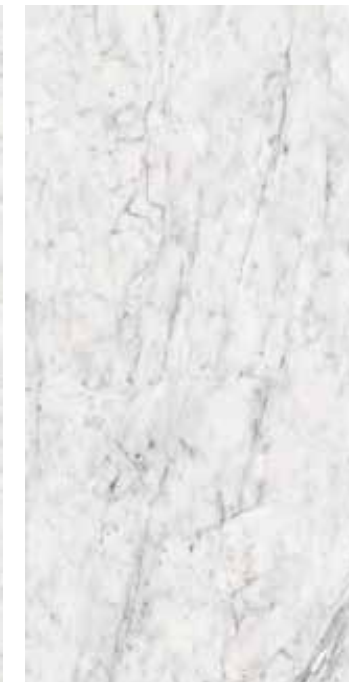

**M** LUCE MATT RECT  
60 X 120 / 24" X 48" **R60/M**

**M C2** LUCE C2 RECT  
60 X 120 / 24" X 48" **N67/M**



**M** LUCE MATT RECT.  
60 X 60 / 24" X 24" **P07/M**

**M C2** LUCE C2 RECT.  
60 X 60 / 24" X 24" **N18/M**



**M** LUCE MATT RECT.  
30 X 60 / 12" X 24" **P07/M**

**M C2** LUCE C2 RECT.  
30 X 60 / 12" X 24" **N18/M**

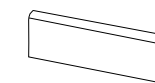

RODAPIE LUCE MATT  
7.5 X 60 / 3" X 24" **K24/P**

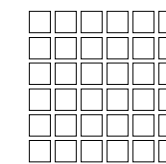

MALLA LUCE MATT  
30X30 (5X5) /12" X 12" **K01/P**

### CARACTERÍSTICAS TÉCNICAS - TECHNICAL CHARACTERISTICS

- P** PORCELÁNICO/PORCELAIN TILES  
GRÉS CERÁME/FEINSTEINZEUG
- RECTIFICADO/RECTIFIED**  
RECTIFIÉ/KALIBRIERT
- V2** VARIACION LEVE/SLIGHT VARIATION  
LÉGERÉ VARIATION/LEICHT FARBSPIEL
- ESPEJOR/THICKNESS:**  
120X120 - 11,5mm/0,45"  
60X120 - 10,5mm/0,41"  
30X60 - 10mm/0,39"  
60X60 - 10mm/0,39"
- VARIACIÓN DE DISEÑO/GRAPHIC FACES**  
120X120- 8 PIEZAS/PIECES  
60X120- 16 PIEZAS/PIECES  
60X60- 32 PIEZAS/PIECES  
30X60- 64 PIEZAS/PIECES



# Wabi Sabi

**A combined style for the swimming pool and the whole house.**

**Un estilo combinado en la piscina y en toda la casa.**

We present Wabi Sabi, a collection that reflects our commitment to design.

Wabi Sabi is one of APE GRUPO's most complete collections. Its materials, finishes, formats and textures has been meticulously studied and crafted so that all the pieces coexist in the same environment, creating spaces adapted to each client.

Wabi Sabi's goal is to offer a collection that allows us to work in a project of any domain from beginning to end.

It is a collection capable of adapting to all rooms. It allows us to combine stone, marble and wood, as well as colors and finishes, with the security of giving homogeneity to the project. Each combination offers a different personality.

Presentamos Wabi Sabi, una colección que refleja nuestro compromiso con el diseño.

Wabi Sabi es una de las colecciones más completas de APE GRUPO. El estudio de materiales, acabados, formatos y texturas que la componen han sido minuciosamente trabajadas para que todas las piezas convivan en el mismo entorno, creando espacios adaptados a cada cliente.

El objetivo de Wabi Sabi es ofrecer una colección que permita trabajar un proyecto de cualquier ámbito de principio a fin.

Se trata de una colección capaz de adaptarse a todas las estancias; permite combinar piedra, mármol y maderas, así como colores y acabados con la seguridad de dar homogeneidad al proyecto. Cada combinación ofrece una personalidad diferente

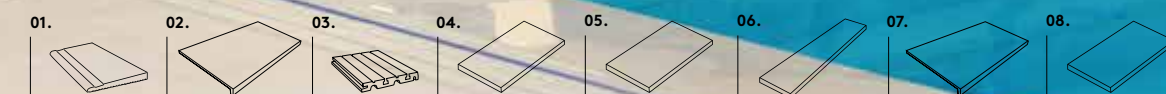

01. BORDE DESBORDANTE WABI SABBIA 28X66,5/11"X26" 02. PELDAÑO RECTO ANT. MADAGASCAR NOGE 33X120X3/13"X48"X1" 03. REJILLA WABI SABBIA 24,5X24,5/9,4"X9,4"  
04. STRU. WABI SABBIA RECT. 60X120/24"X48" 05. TRAVERTINO BRESCIA MATT RECT. 60X120/24"X48" 06. ANTI-SLIP MADAGASCAR NOGE RECT. 20X120/8"X48"  
07. PELDAÑO RECTO ANT. C3 WABI SABBIA 33X120X3/13"X48"X1" 08. WABI SABBIA LAP. RECT. 30X60/12"X24"



# Wabi Sabi

APE

Wabi Sabi Pools

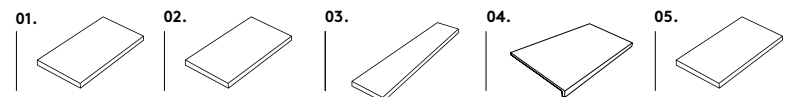

01. STRU. WABI TAUPE RECT. 60X120/24"X48" 02. TRAVERTINO SILVER MATT RECT. 60X120/24"X48"  
03. ANTI-SLIP MADAGASCAR NOCE RECT. 20X120/8"X48" 04. PELDAÑO RECTO ANT. MADAGASCAR NOCE 33X120X3/13"X48"X1" 05. WABI TAUPE LAP. RECT. 60X120/24"X48"



# Wabi Sabi

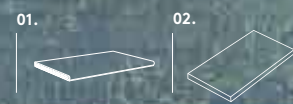

01. BORDE SKIMMER TRAVERTINO BRESCIA 45X75/18"X30" 02. TRAVERTINO BRESCIA STRUJ. RECT. 60X120/24"X48"



# Wabi Sabi



01. STRU WABI TAUPE RECT. 60X60/24"X24" 02. BORDE DESBORDANTE WABI TAUPE 28X66,5/11"X26" 03. REJILLA WABI TAUPE 24,5X24,5/9,4"X9,4"  
 04. WABI TAUPE LAP. RECT. 30X60/12"X24" 05. PELDAÑO RECTO ANT. C3 WABI TAUPE 33X120X3/13"X48"X1" 06. ANTI-SLIP MADAGASCAR NOCE RECT. 20X120/8"X48"  
 07. PELDAÑO RECTO ANT. MADAGASCAR NOCE 33X120/13"X48"

Wabi Sabi is one of the most complete collections. It allows us to create traditional and overflow pools, and is conceived to accompany the user throughout the whole project.

Wabi Sabi es una de las colecciones más completas. No solo permite crear piscinas tradicionales y desbordantes, sino que está especialmente pensada para acompañar al usuario en todo el proyecto.





## PELDAÑO RECTO

WABI



**C3** PELDAÑO RECTO ANT. C3 WABI BIANCO 33 X 120 / 13" X 48" **K91/P** **C3** PELDAÑO RECTO ANT. C3 WABI GRAFITE 33 X 120 / 13" X 48" **K91/P** **C3** PELDAÑO RECTO ANT. C3 WABI SABBIA 33 X 120 / 13" X 48" **K91/P** **C3** PELDAÑO RECTO ANT. C3 WABI TAUPE 33 X 120 / 13" X 48" **K91/P**

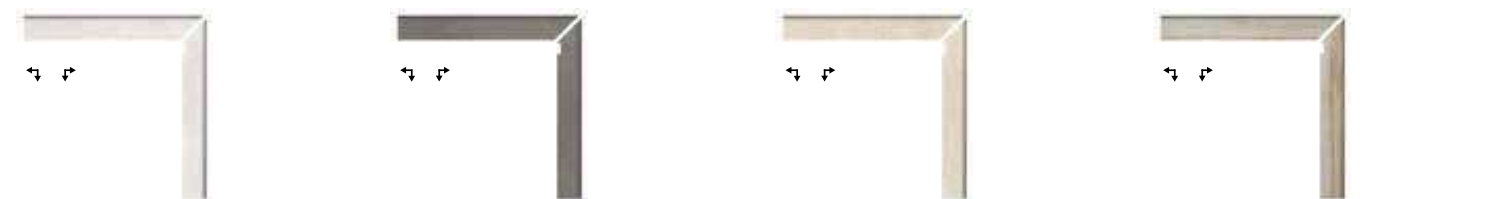

ZANQUIN RECTO DCHA./IZQ. WABI BIANCO 7,5 X 60 / 3" X 24" **K09/P** ZANQUIN RECTO DCHA./IZQ. WABI GRAFITE 7,5 X 60 / 3" X 24" **K09/P** ZANQUIN RECTO DCHA./IZQ. WABI SABBIA 7,5 X 60 / 3" X 24" **K09/P** ZANQUIN RECTO DCHA./IZQ. WABI TAUPE 7,5 X 60 / 3" X 24" **K09/P**

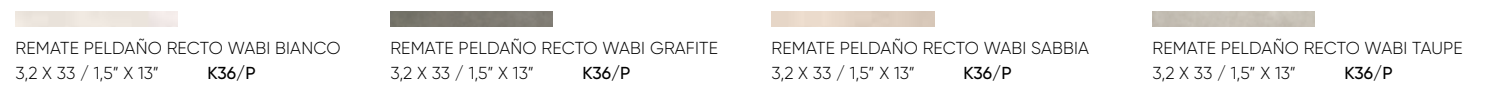

REMATE PELDAÑO RECTO WABI BIANCO 3,2 X 33 / 1,5" X 13" **K36/P** REMATE PELDAÑO RECTO WABI GRAFITE 3,2 X 33 / 1,5" X 13" **K36/P** REMATE PELDAÑO RECTO WABI SABBIA 3,2 X 33 / 1,5" X 13" **K36/P** REMATE PELDAÑO RECTO WABI TAUPE 3,2 X 33 / 1,5" X 13" **K36/P**

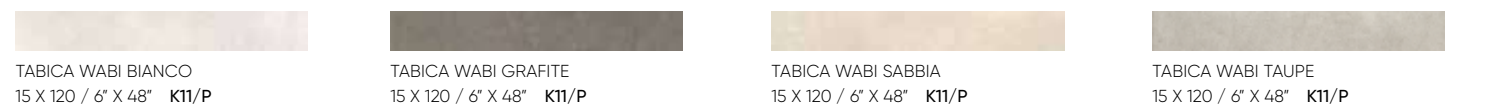

TABICA WABI BIANCO 15 X 120 / 6" X 48" **K11/P** TABICA WABI GRAFITE 15 X 120 / 6" X 48" **K11/P** TABICA WABI SABBIA 15 X 120 / 6" X 48" **K11/P** TABICA WABI TAUPE 15 X 120 / 6" X 48" **K11/P**

## PELDAÑO RECTO

TRAVERTINO



**C3** PELDAÑO RECTO ANT. C3 TRAVERTINO SILVER 33 X 120 / 13" X 48" **K91/P** **C3** PELDAÑO RECTO ANT. C3 TRAVERTINO BRESCIA 33 X 120 / 13" X 48" **K91/P** **C3** PELDAÑO RECTO ANT. C3 MADAGASCAR NOCE 33 X 120 / 13" X 48" **K91/P**



ZANQUIN RECTO DCHA./IZQ. TRAVERTINO SILVER POL ZANQUIN RECTO DCHA./IZQ. TRAVERTINO SILVER MATT 7,5 X 60 / 3" X 24" **K09/P** ZANQUIN RECTO DCHA./IZQ. TRAVERTINO BRESCIA POL ZANQUIN RECTO DCHA./IZQ. TRAVERTINO BRESCIA MATT 7,5 X 60 / 3" X 24" **K09/P** ZANQUIN RECTO DCHA./IZQ. MADAGASCAR NOCE 10 X 60 / 4" X 24" **K09/P**

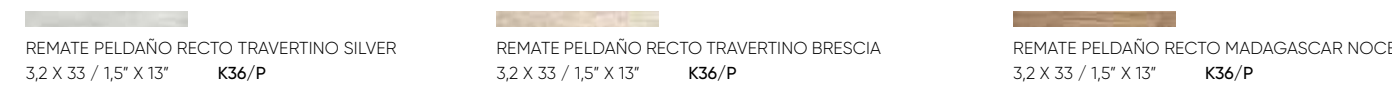

REMATE PELDAÑO RECTO TRAVERTINO SILVER 3,2 X 33 / 1,5" X 13" **K36/P** REMATE PELDAÑO RECTO TRAVERTINO BRESCIA 3,2 X 33 / 1,5" X 13" **K36/P** REMATE PELDAÑO RECTO MADAGASCAR NOCE 3,2 X 33 / 1,5" X 13" **K36/P**



TABICA TRAVERTINO SILVER 15 X 120 / 6" X 48" **K11/P** TABICA TRAVERTINO BRESCIA 15 X 120 / 6" X 48" **K11/P** TABICA MADAGASCAR NOCE 15 X 120 / 6" X 48" **K11/P**

## PELDAÑO FIORENTINO

TRAVERTINO



**C3** PELDAÑO FIOR. ANT. C3 TRAVERTINO SILVER 33X120 / 13"X48" **K91/P** **C3** PELDAÑO FIOR. ANT. C3 TRAVERTINO BRESCIA 33X120 / 13"X48" **K91/P**

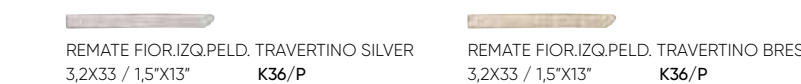

REMATE FIOR.IZQ.PELD. TRAVERTINO SILVER 3,2X33 / 1,5"X13" **K36/P** REMATE FIOR.IZQ.PELD. TRAVERTINO BRESCIA 3,2X33 / 1,5"X13" **K36/P**



REMATE FIOR.DER.PELD. TRAVERTINO SILVER 3,2X33 / 1,5"X13" **K36/P** REMATE FIOR.DER.PELD. TRAVERTINO BRESCIA 3,2X33 / 1,5"X13" **K36/P**

### CARACTERÍSTICAS TÉCNICAS · TECHNICAL CHARACTERISTICS

-  EXTRUSIONADO/EXTRUDED KLINKER
-  MATE/MATT
-  RECTIFICADO/RECTIFIED
-  VARIACION LEVE/SLIGHT VARIATION
-  ANTI-SLIP R11
-  (DCOF) >0.50
-  CLASE 3/CLASS 3
-  ANTI-SLIP BAREFOOT A+B+C

-  DORSO ESTRIADO EN COLA DE MILANO. DOVE TAIL PROFILE.
-  JUNTA RECOMENDADA 5 MM. RECOMMENDED JOINT BETWEEN PIECES 5 MM.



# Wabi Sabi

## OVERFLOW POOL / PISCINA DESBORDANTE

WABI



BORDE DESBORDANTE WABI BIANCO  
28 X 66,5 / 11" X 26" K94/P



BORDE DESBORDANTE WABI SABBIA  
28 X 66,5 / 11" X 26" K94/P



BORDE DESBORDANTE WABI TAUPE  
28 X 66,5 / 11" X 26" K94/P



REJILLA WABI BIANCO  
24,5 X 24,5 / 9,4" X 9,4" K57/P



REJILLA WABI SABBIA  
24,5 X 24,5 / 9,4" X 9,4" K57/P



REJILLA WABI TAUPE  
24,5 X 24,5 / 9,4" X 9,4" K57/P



MEDIA CAÑA WABI BIANCO  
4 X 33 / 1,5" X 13" K29/P



MEDIA CAÑA WABI SABBIA  
4 X 33 / 1,5" X 13" K29/P



MEDIA CAÑA WABI TAUPE  
4 X 33 / 1,5" X 13" K29/P



ARISTA WABI BIANCO  
4 X 33 / 1,5" X 13" K29/P



ARISTA WABI SABBIA  
4 X 33 / 1,5" X 13" K29/P



ARISTA WABI TAUPE  
4 X 33 / 1,5" X 13" K29/P



UÑA ARISTA WABI BIANCO  
3 X 3 / 1,2" X 1,2" K06/P



UÑA ARISTA WABI SABBIA  
3 X 3 / 1,2" X 1,2" K06/P



UÑA ARISTA WABI TAUPE  
3 X 3 / 1,2" X 1,2" K06/P



UÑA CAÑA WABI BIANCO  
4 X 4 / 1,5" X 1,5" K06/P



UÑA CAÑA WABI SABBIA  
4 X 4 / 1,5" X 1,5" K06/P



UÑA CAÑA WABI TAUPE  
4 X 4 / 1,5" X 1,5" K06/P

## TRADITIONAL POOL / PISCINA TRADICIONAL

WABI



BORDE SKIMMER WABI BIANCO  
45 X 75 / 18" X 30" K93/P



BORDE SKIMMER WABI SABBIA  
45 X 75 / 18" X 30" K93/P



BORDE SKIMMER WABI TAUPE  
45 X 75 / 18" X 30" K93/P

APE

## OVERFLOW POOL / PISCINA DESBORDANTE

TRAVERTINO



BORDE DESBORDANTE TRAVERTINO SILVER  
28 X 66,5 / 11" X 26" K94/P



BORDE DESBORDANTE TRAVERTINO BRESCIA  
28 X 66,5 / 11" X 26" K94/P



REJILLA TRAVERTINO SILVER  
24,5 X 24,5 / 9,4" X 9,4" K57/P



REJILLA TRAVERTINO BRESCIA  
24,5 X 24,5 / 9,4" X 9,4" K57/P



MEDIA CAÑA TRAVERTINO SILVER  
4 X 33 / 1,5" X 13" K29/P



MEDIA CAÑA TRAVERTINO BRESCIA  
4 X 33 / 1,5" X 13" K29/P



ARISTA TRAVERTINO SILVER  
4 X 33 / 1,5" X 13" K29/P



ARISTA TRAVERTINO BRESCIA  
4 X 33 / 1,5" X 13" K29/P



UÑA ARISTA TRAVERTINO SILVER  
3 X 3 / 1,2" X 1,2" K06/P



UÑA ARISTA TRAVERTINO BRESCIA  
3 X 3 / 1,2" X 1,2" K06/P



UÑA CAÑA TRAVERTINO SILVER  
4 X 4 / 1,5" X 1,5" K06/P



UÑA CAÑA TRAVERTINO BRESCIA  
4 X 4 / 1,5" X 1,5" K06/P

## TRADITIONAL POOL / PISCINA TRADICIONAL

TRAVERTINO



BORDE SKIMMER TRAVERTINO SILVER  
45 X 75 / 18" X 30" K93/P



BORDE SKIMMER TRAVERTINO BRESCIA  
45 X 75 / 18" X 30" K93/P

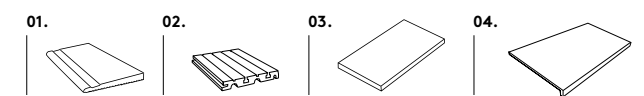
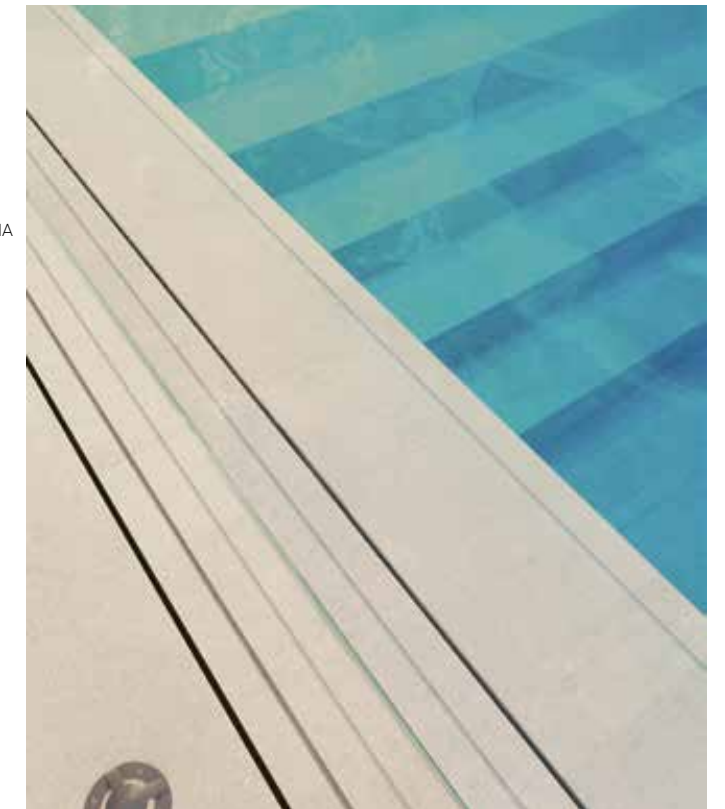

- 01. BORDE DESBORDANTE WABI SABBIA 28X66,5/11"X26"
- 02. REJILLA WABI SABBIA 24,5X24,5/9,4"X9,4"
- 03. STRU WABI SABBIA RECT. 60X120/24"X48"
- 04. PELDAÑO RECTO ANT. C3 WABI SABBIA 33X120/13"X48"

### CARACTERÍSTICAS TÉCNICAS - TECHNICAL CHARACTERISTICS

- E** EXTRUSIONADO/EXTRUDED KLINKER
- M** MATE/MATT
- V2** VARIACION LEVE/SLIGHT VARIATION
- R11** ANTI-SLIP R11
- (DCOF) >0.50**
- C3** CLASE 3/CLASS 3
- A+B+C** ANTI-SLIP BAREFOOT A+B+C

- DORSO ESTRIADO EN COLA DE MILANO. DOVE TAIL PROFILE.**
- JUNTA RECOMENDADA 5 MM. RECOMMENDED JOINT BETWEEN PIECES 5 MM.**



ARISTA  
4X33 / 1,5"X13"



MEDIA CAÑA  
4X33 / 1,5"X13"



# Wabi Sabi



APE

Wabi Sabi Pools



PELDAÑO RECTO WABI



BORDE SKIMMER WABI



PELDAÑO FIOR. ANT. TRAVERTINO



BORDE DESBORDANTE TRAVERTINO



REJILLA TRAVERTINO



# Wabi Sabi

## BASES



**C2 R10** WABI BIANCO LAPATTO RECT.  
120 X 120 / 48" X 48"

P05/M



**C2 R10** WABI BIANCO LAPATTO RECT.  
60 X 120 / 24" X 48"

N37/M



**C2 R10** WABI BIANCO LAPATTO RECT.  
60 X 60 / 24" X 24"

N43/M

**M C3 R11** STRU WABI BIANCO RECT.  
60 X 60 / 24" X 24"

N33/M

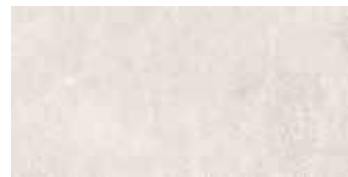

**C2 R10** WABI BIANCO LAPATTO RECT.  
30 X 60 / 12" X 24"

N43/M

**M C3 R11** STRU WABI BIANCO RECT.  
60 X 120 / 24" X 48"

N74/M

**M C3 R11** STRU WABI BIANCO RECT.  
30 X 60 / 12" X 24"

N33/M



**M V3** MADAGASCAR NOCE RECT.  
20 X 120 / 8" X 48"

R52/M

**M C3 R11 V3** ANTI-SLIP MADAGASCAR NOCE RECT.  
20 X 120 / 8" X 48"

N72/M



**M V4** MACCHIATO BIANCO RECT.  
20 X 120 / 8" X 48"

R52/M



**M V3** MADAGASCAR BIANCO RECT.  
20 X 120 / 8" X 48"

R52/M



**M V3** SABI BIANCO RECT.  
75 X 75 / 30" X 30"

R52/M



**M V3** SABI NOCE RECT.  
75 X 75 / 30" X 30"

N47/M

N47/M

APE

Wabi Sabi Pools

## BASES



**M** INVISIBLE GOLD MATT RECT.  
120 X 120 / 48" X 48"

N31/M

**M C2** INVISIBLE GOLD C2 RECT.  
120 X 120 / 48" X 48"

N34/M

**E** INVISIBLE GOLD POL. RECT.  
120 X 120 / 48" X 48"

P06/M



**M** INVISIBLE GOLD MATT RECT.  
60 X 120 / 24" X 48"

R60/M

**M C2** INVISIBLE GOLD C2 RECT.  
60 X 120 / 24" X 48"

N67/M

**E** INVISIBLE GOLD POL. RECT.  
60 X 120 / 24" X 48"

J18/M



**M** INVISIBLE GOLD MATT RECT.  
60 X 60 / 24" X 24"

P07/M

**M C2** INVISIBLE GOLD C2 RECT.  
60 X 60 / 24" X 24"

N18/M

**E** INVISIBLE GOLD POL. RECT.  
60 X 60 / 24" X 24"

N29/M



**M** INVISIBLE GOLD MATT RECT.  
30 X 60 / 12" X 24"

P07/M

**M C2** INVISIBLE GOLD C2 RECT.  
30 X 60 / 12" X 24"

N18/M

**E** INVISIBLE GOLD POL. RECT.  
30 X 60 / 12" X 24"

N29/M



**E** INVISIBLE GOLD POL. RECT.  
90 X 180 / 36" X 72"

P35/M

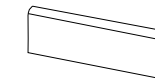

RODAPIÉ

WABI 75X60 / 3"X24" **K24/P\***

MADAGASCAR 10X120 / 4"X48" **K02/P**

INVISIBLE, TRAVERTINO, OROBICO POL. 75X60 / 3"X24" **K29/P**

INVISIBLE, TRAVERTINO, OROBICO MATT 75X60 / 3"X24" **K24/P**

\* (DISPONIBLE EN TODOS LOS COLORES / AVAILABLE IN ALL COLORS)

### CARACTERÍSTICAS TÉCNICAS · TECHNICAL CHARACTERISTICS

**P** PORCELÁNICO / PORCELAIN TILES

**R** RECTIFICADO / RECTIFIED

**M** MASA COLOREADA / COLORED BODY

**V2** VARIACION LEVE / SLIGHT VARIATION

**H** ESPESOR / THICKNESS:

120X120 - 11,5mm / 0,45"

60X120 - 10,5mm / 0,41"

75X75 - 11mm / 0,43"

20X120 - 10mm / 0,39"

30X60 - 10mm / 0,39"

60X60 - 10mm / 0,39"



# Wabi Sabi

## BASES

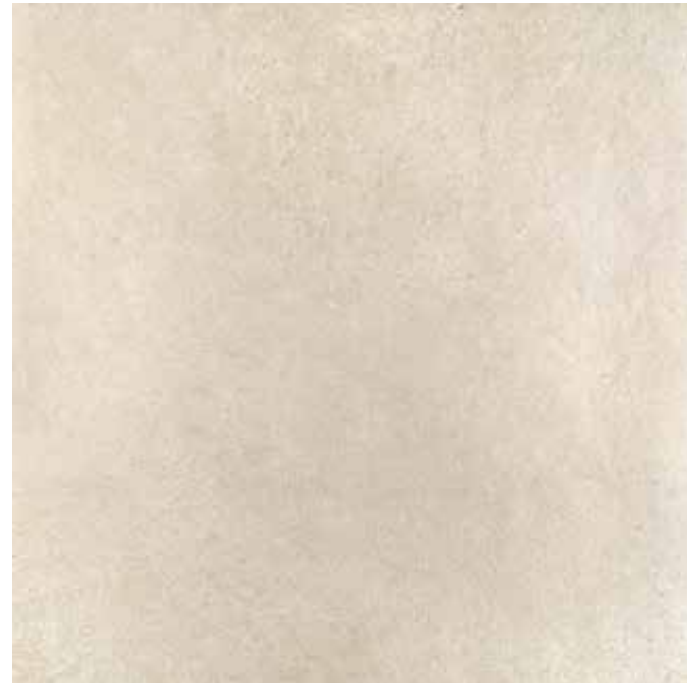

**M C2 R10** WABI SABBIA LAPATTO RECT.  
120 X 120 / 48" X 48"

P05/M



**M C2 R10** WABI SABBIA LAPATTO RECT.  
60 X 120 / 24" X 48" N37/M

**M C3 R11** STRU WABI SABBIA RECT.  
60 X 120 / 24" X 48" N74/M



**M C2 R10** WABI SABBIA LAPATTO RECT.  
60 X 60 / 24" X 24" N43/M

**M C3 R11** STRU WABI SABBIA RECT.  
60 X 60 / 24" X 24" N33/M



**M C2 R10** WABI SABBIA LAPATTO RECT.  
30 X 60 / 12" X 24" N43/M

**M C3 R11** STRU WABI SABBIA RECT.  
30 X 60 / 12" X 24" N33/M



**M V3** MADAGASCAR NOCE RECT.  
20 X 120 / 8" X 48"

R52/M

**M C3 R11 V3** ANTI-SLIP MADAGASCAR NOCE RECT.  
20 X 120 / 8" X 48"

N72/M



**M V4** MACCHIATO SABBIA RECT.  
20 X 120 / 8" X 48"

R52/M



**M V3** MADAGASCAR SABBIA RECT.  
20 X 120 / 8" X 48"

R52/M

### CARACTERÍSTICAS TÉCNICAS · TECHNICAL CHARACTERISTICS

- P** PORCELÁNICO/PORCELAIN TILES
- R** RECTIFICADO/RECTIFIED
- M** MASA COLOREADA/COLORED BODY
- V2** VARIACION LEVE/SLIGHT VARIATION
- T** ESPESOR/THICKNESS:  
120X120 - 11,5mm/0,45"  
60X120 - 10,5mm/0,41"  
75X75 - 11mm/0,43"  
20X120 - 10mm/0,39"  
30X60 - 10mm/0,39"  
60X60 - 10mm/0,39"

## BASES



**M** TRAVERTINO BRESCIA MATT RECT.  
120 X 120 / 48" X 48"

N31/M

**M C2** TRAVERTINO BRESCIA C2 RECT.  
120 X 120 / 48" X 48"

N34/M

**E** TRAVERTINO BRESCIA POL. RECT.  
120 X 120 / 48" X 48"

P06/M



**M** TRAVERTINO BRESCIA MATT RECT.  
60 X 120 / 24" X 48"

R60/M

**M C2** TRAVERTINO BRESCIA C2 RECT.  
60 X 120 / 24" X 48"

N67/M

**M C3 R11** TRAVERTINO BRESCIA STRU RECT.  
60 X 120 / 24" X 48"

N74/M

**E** TRAVERTINO BRESCIA POL. RECT.  
60 X 120 / 24" X 48"

J18/M



**M** TRAVERTINO BRESCIA MATT RECT.  
60 X 60 / 24" X 24"

P07/M

**M C2** TRAVERTINO BRESCIA C2 RECT.  
60 X 60 / 24" X 24"

N18/M

**M C3 R11** TRAVERTINO BRESCIA STRU RECT.  
60 X 60 / 24" X 24"

N33/M

**E** TRAVERTINO BRESCIA POL. RECT.  
60 X 60 / 24" X 24"

N29/M



**M** TRAVERTINO BRESCIA MATT RECT.  
30 X 60 / 12" X 24"

P07/M

**M C2** TRAVERTINO BRESCIA C2 RECT.  
30 X 60 / 12" X 24"

N18/M

**M C3 R11** TRAVERTINO BRESCIA STRU RECT.  
30 X 60 / 12" X 24"

N33/M

**E** TRAVERTINO BRESCIA POL. RECT.  
30 X 60 / 12" X 24"

N29/M



**M V3** SABI SABBIA RECT.  
75 X 75 / 30" X 30"

N47/M



**M V3** SABI NOCE RECT.  
75 X 75 / 30" X 30"

N47/M

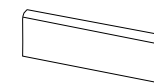

RODAPIÉ  
WABI 75X60 / 3"X24" K24/P\*  
MADAGASCAR 10X120 / 4"X48" K02/P  
INVISIBLE, TRAVERTINO, OROBICO POL. 75X60 / 3"X24" K29/P  
INVISIBLE, TRAVERTINO, OROBICO MATT 75X60 / 3"X24" K24/P

\* (DISPONIBLE EN TODOS LOS COLORES / AVAILABLE IN ALL COLORS)



# Wabi Sabi

## BASES



**M C2 R10** WABI TAUPE LAPATTO RECT.  
120 X 120 / 48" X 48"

P05/M



**M C2 R10** WABI TAUPE LAPATTO RECT.  
60 X 120 / 24" X 48" N37/M

**M C3 R11** STRU WABI TAUPE RECT.  
60 X 120 / 24" X 48" N74/M



**M C2 R10** WABI TAUPE LAPATTO RECT.  
60 X 60 / 24" X 24" N43/M

**M C3 R11** STRU WABI TAUPE RECT.  
60 X 60 / 24" X 24" N33/M



**M C2 R10** WABI TAUPE LAPATTO RECT.  
30 X 60 / 12" X 24" N43/M

**M C3 R11** STRU WABI TAUPE RECT.  
30 X 60 / 12" X 24" N33/M



**M V3** MADAGASCAR NOCE RECT.  
20 X 120 / 8" X 48"

R52/M

**M C3 R11 V3** ANTI-SLIP MADAGASCAR NOCE RECT.  
20 X 120 / 8" X 48"

N72/M



**M V4** MACCHIATO TAUPE RECT.  
20 X 120 / 8" X 48"

R52/M



**M V3** MADAGASCAR TAUPE RECT.  
20 X 120 / 8" X 48"

R52/M

### CARACTERÍSTICAS TÉCNICAS · TECHNICAL CHARACTERISTICS

- P** PORCELÁNICO / PORCELAIN TILES
- R** RECTIFICADO / RECTIFIED
- M** MASA COLOREADA / COLORED BODY
- V2** VARIACION LEVE / SLIGHT VARIATION
- T** ESPESOR / THICKNESS:  
120X120 - 11,5mm / 0,45"  
60X120 - 10,5mm / 0,41"  
75X75 - 11mm / 0,43"  
20X120 - 10mm / 0,39"  
30X60 - 10mm / 0,39"  
60X60 - 10mm / 0,39"

## BASES



**M** TRAVERTINO SILVER MATT RECT.  
120 X 120 / 48" X 48"

N31/M

**M C2** TRAVERTINO SILVER C2 RECT.  
120 X 120 / 48" X 48"

N34/M

**E** TRAVERTINO SILVER POL. RECT.  
120 X 120 / 48" X 48"

P06/M



**M** TRAVERTINO SILVER MATT RECT.  
60 X 120 / 24" X 48"

R60/M

**M C2** TRAVERTINO SILVER C2 RECT.  
60 X 120 / 24" X 48"

N67/M

**M C3 R11** TRAVERTINO SILVER STRU RECT.  
60 X 120 / 24" X 48"

N74/M

**E** TRAVERTINO SILVER POL. RECT.  
60 X 120 / 24" X 48"

J18/M



**M** TRAVERTINO SILVER MATT RECT.  
60 X 60 / 24" X 24"

P07/M

**M C2** TRAVERTINO SILVER C2 RECT.  
60 X 60 / 24" X 24"

N18/M

**M C3 R11** TRAVERTINO SILVER STRU RECT.  
60 X 60 / 24" X 24"

N33/M

**E** TRAVERTINO SILVER POL. RECT.  
60 X 60 / 24" X 24"

N29/M



**M** TRAVERTINO SILVER MATT RECT.  
30 X 60 / 12" X 24"

P07/M

**M C2** TRAVERTINO SILVER C2 RECT.  
30 X 60 / 12" X 24"

N18/M

**M C3 R11** TRAVERTINO SILVER STRU RECT.  
30 X 60 / 12" X 24"

N33/M

**E** TRAVERTINO SILVER POL. RECT.  
30 X 60 / 12" X 24"

N29/M



**M V3** SABI TAUPE RECT.  
75 X 75 / 30" X 30"

N47/M



**M V3** SABI NOCE RECT.  
75 X 75 / 30" X 30"

N47/M

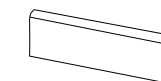

RODAPIÉ  
WABI 75X60 / 3"X24" K24/P \*  
MADAGASCAR 10X120 / 4"X48" K02/P  
INVISIBLE, TRAVERTINO, OROBICO POL. 75X60 / 3"X24" K29/P  
INVISIBLE, TRAVERTINO, OROBICO MATT 75X60 / 3"X24" K24/P

\* (DISPONIBLE EN TODOS LOS COLORES / AVAILABLE IN ALL COLORS)



# Wabi Sabi

## BASES

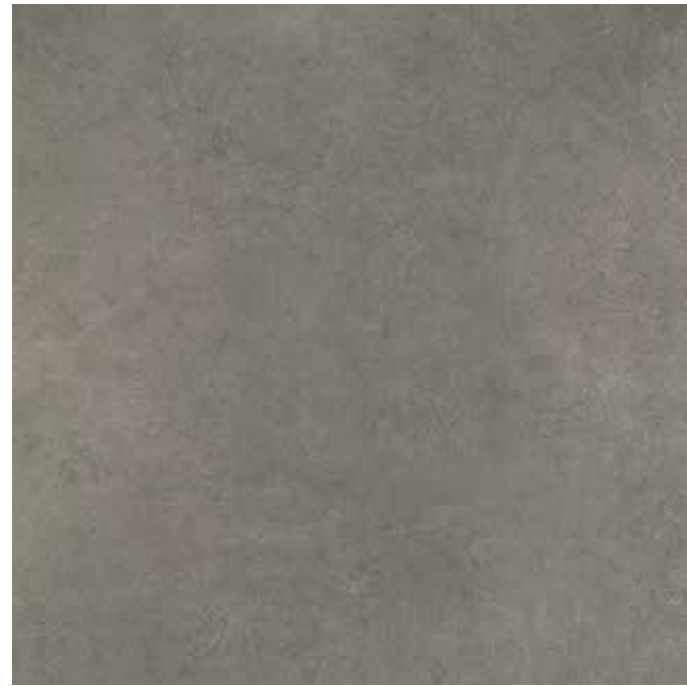

**M C2 R10** WABI GRAFITE LAPATTO RECT.  
120 X 120 / 48" X 48"

P05/M



**M C2 R10** WABI GRAFITE LAPATTO RECT.  
60 X 120 / 24" X 48"

N37/M



**M C2 R10** WABI GRAFITE LAPATTO RECT.  
60 X 60 / 24" X 24"

N43/M

**M C3 R11** STRU WABI GRAFITE RECT.  
60 X 60 / 24" X 24"

N33/M



**M C2 R10** WABI GRAFITE LAPATTO RECT.  
30 X 60 / 12" X 24"

N43/M

**M C3 R11** STRU WABI GRAFITE RECT.  
60 X 120 / 24" X 48"

N74/M

**M C3 R11** STRU WABI GRAFITE RECT.  
30 X 60 / 12" X 24"

N33/M



**M V3** MADAGASCAR NOCE RECT.  
20 X 120 / 8" X 48"

R52/M

**M C3 R11 V3** ANTI-SLIP MADAGASCAR NOCE RECT.  
20 X 120 / 8" X 48"

N72/M

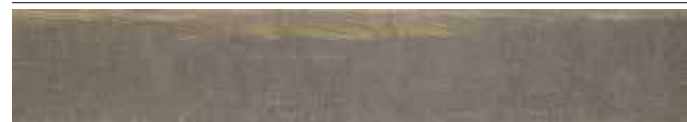

**M V4** MACCHIATO GRAFITE RECT.  
20 X 120 / 8" X 48"

R52/M



**M V3** MADAGASCAR GRAFITE RECT.  
20 X 120 / 8" X 48"

R52/M

### CARACTERÍSTICAS TÉCNICAS · TECHNICAL CHARACTERISTICS

- P** PORCELÁNICO / PORCELAIN TILES
- R** RECTIFICADO / RECTIFIED
- M** MASA COLOREADA / COLORED BODY
- V2** VARIACION LEVE / SLIGHT VARIATION
- T** ESPESOR / THICKNESS:  
120X120 - 11,5mm / 0,45"  
60X120 - 10,5mm / 0,41"  
75X75 - 11mm / 0,43"  
20X120 - 10mm / 0,39"  
30X60 - 10mm / 0,39"  
60X60 - 10mm / 0,39"

## BASES



**M** OROBICO GRIGIO MATT RECT.  
120 X 120 / 48" X 48"

N31/M

**M C2** OROBICO GRIGIO C2 RECT.  
120 X 120 / 48" X 48"

N34/M

**E** OROBICO GRIGIO POL. RECT.  
120 X 120 / 48" X 48"

P06/M



**M** OROBICO GRIGIO MATT RECT.  
60 X 120 / 24" X 48"

R60/M

**M C2** OROBICO GRIGIO C2 RECT.  
60 X 120 / 24" X 48"

N67/M

**E** OROBICO GRIGIO POL. RECT.  
60 X 120 / 24" X 48"

J18/M



**M** OROBICO GRIGIO MATT RECT.  
60 X 60 / 24" X 24"

P07/M

**M C2** OROBICO GRIGIO C2 RECT.  
60 X 60 / 24" X 24"

N18/M

**E** OROBICO GRIGIO POL. RECT.  
60 X 60 / 24" X 24"

N29/M



**M** OROBICO GRIGIO MATT RECT.  
30 X 60 / 12" X 24"

P07/M

**M C2** OROBICO GRIGIO C2 RECT.  
30 X 60 / 12" X 24"

N18/M

**E** OROBICO GRIGIO POL. RECT.  
30 X 60 / 12" X 24"

N29/M



**M V3** SABI GRAFITE RECT.  
75 X 75 / 30" X 30"

N47/M



**M V3** SABI NOCE RECT.  
75 X 75 / 30" X 30"

N47/M

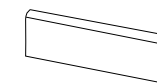

RODAPIÉ  
WABI 75X60 / 3"X24" **K24/P** \*  
MADAGASCAR 10X120 / 4"X48" **K02/P**  
INVISIBLE, TRAVERTINO, OROBICO POL. 75X60 / 3"X24" **K29/P**  
INVISIBLE, TRAVERTINO, OROBICO MATT 75X60 / 3"X24" **K24/P**

\* (DISPONIBLE EN TODOS LOS COLORES / AVAILABLE IN ALL COLORS)



# Work

**An Italian collection ideal for swimming pools, terraces and indoors.**

**Colección de firma italiana ideal para piscinas, terrazas e interiores.**

Fruit of the collaboration with the Italian architect Luigi Romanelli, we present the Work collection. Thanks to its special pieces, you can create both traditional and overflow pools. Its combination of concrete and wood and its variety of colors make it ideal not only for outdoors but also indoors.

Fruto de la colaboración con el arquitecto italiano Luigi Romanelli nace la colección Work. Gracias a sus piezas especiales se pueden crear piscinas tanto tradicionales como desbordantes. Su combinación de cementos y maderas y su variedad de colores la convierten en una colección ideal tanto para exteriores como para interiores.



APE

Work Pools

- 01. ANTI-SLIP WORK B COAL RECT. 30X60/12"X24"
- 02. BORDE DESBORDANTE WORK B COAL 28X66,5/11"X26"
- 03. REJILLA WORK B COAL 24,5X24,5/9,4"X9,4"
- 04. MEDIA CAÑA WORK B COAL 4X33/1,5"X13"
- 05. PELDAÑO RECTO ANT. C3 WORK B COAL 33X120X3/13"X48"X1"
- 06. TABICA WORK B COAL 15X120/6"X48"
- 07. UNA CAÑA WORK B COAL 4X4/1,5"X1,5"
- 08. WORK W NATURAL RECT. 30X120/12"X48"



# Work

APE

Work Pools

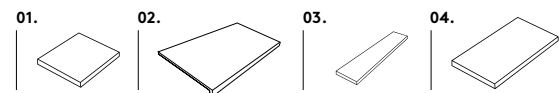

01. ANTI-SLIP WORK B CENERE RECT. 60X120/24"X48" 02. PELDAÑO RECTO ANT. C3 WORK B CENERE 33X120X3/13"X48"X1" 03. TABICA WORK B CENERE 15X120/6"X48"  
04. WORK B CENERE RECT. 30X60/12"X24"



# Work

## PELDAÑO RECTO



**C3** PELDAÑO RECTO ANT. C3 WORK B BIANCO 33 X 120 / 13" X 48" **K91/P** **C3** PELDAÑO RECTO ANT. C3 WORK B CENERE 33 X 120 / 13" X 48" **K91/P** **C3** PELDAÑO RECTO ANT. C3 WORK B COAL 33 X 120 / 13" X 48" **K91/P** **C3** PELDAÑO RECTO ANT. C3 WORK B TAUPE 33 X 120 / 13" X 48" **K91/P**



ZANQUIN RECTO DCHA./IZQ. WORK B BIANCO 7,5X60/3"X24" **K09/P** ZANQUIN RECTO DCHA./IZQ. WORK B CENERE 7,5X60/3"X24" **K09/P** ZANQUIN RECTO DCHA./IZQ. WORK B COAL 7,5X60/3"X24" **K09/P** ZANQUIN RECTO DCHA./IZQ. WORK B TAUPE 7,5X60/3"X24" **K09/P**

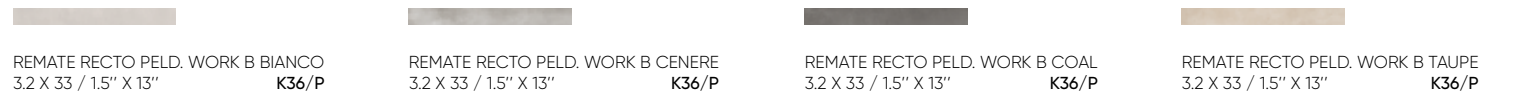

REMATE RECTO PELD. WORK B BIANCO 3,2 X 33 / 1,5" X 13" **K36/P** REMATE RECTO PELD. WORK B CENERE 3,2 X 33 / 1,5" X 13" **K36/P** REMATE RECTO PELD. WORK B COAL 3,2 X 33 / 1,5" X 13" **K36/P** REMATE RECTO PELD. WORK B TAUPE 3,2 X 33 / 1,5" X 13" **K36/P**

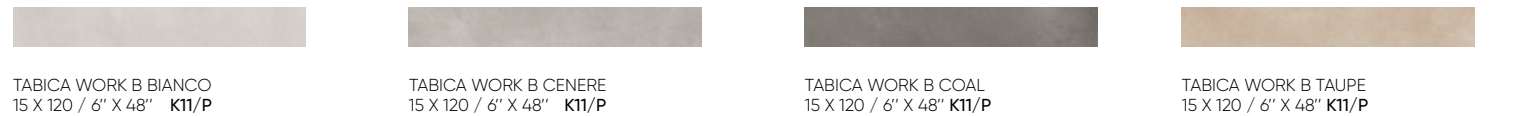

TABICA WORK B BIANCO 15 X 120 / 6" X 48" **K11/P** TABICA WORK B CENERE 15 X 120 / 6" X 48" **K11/P** TABICA WORK B COAL 15 X 120 / 6" X 48" **K11/P** TABICA WORK B TAUPE 15 X 120 / 6" X 48" **K11/P**

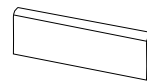

RODAPIÉ  
WORK B 7,5X60 / 3"X24" **K24/P**  
WORK B 7,5X90 / 3"X36" **K14/P**

(DISPONIBLE EN TODOS LOS COLORES / AVAILABLE IN ALL COLORS)

### CARACTERÍSTICAS TÉCNICAS · TECHNICAL CHARACTERISTICS

- K** EXTRUSIONADO/EXTRUDED KLINKER
- M** MATE/MATT
- R** RECTIFICADO/RECTIFIED
- V3** VARIACION MODERADA/MODERATE VARIATION
- R11** ANTI-SLIP R11
- (DCOF) >0.50**
- C3** CLASE 3/CLASS 3
- A+B+C** ANTI-SLIP BAREFOOT A+B+C



DORSO ESTRIADO EN COLA DE MILANO.  
DOVE TAIL PROFILE.



JUNTA RECOMENDADA 5 MM.  
RECOMMENDED JOINT BETWEEN PIECES 5 MM.

# Work

## PELDAÑO RECTO



**C3** PELDAÑO RECTO ANT. C3 WORK W NATURAL 33 X 120 / 13" X 48" **K91/P**

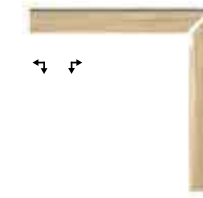

ZANQUIN RECTO DCHA./IZQ. WORK W NATURAL 7,5X60/3"X24" **K09/P**



REMATE RECTO PELD. WORK W NATURAL 3,2 X 33 / 1,5" X 13" **K36/P**



TABICA WORK W NATURAL 15 X 120 / 6" X 48" **K11/P**

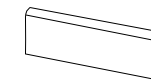

ROD. WORK W NATURAL 10X120 / 4"X48" **K02/P**  
(DISPONIBLE EN TODOS LOS COLORES / AVAILABLE IN ALL COLORS)

## BASES



**V2** WORK W NATURAL RECT. 30 X 120 / 12" X 48" **P12/M**

**C3 R11 V2** ANTI-SLIP WORK W NATURAL RECT. 30 X 120 / 12" X 48" **N24/M**



**V2** WORK W NATURAL RECT. 20 X 120 / 8" X 48" **P12/M**

**C3 R11 V2** ANTI-SLIP WORK W NATURAL RECT. 20 X 120 / 8" X 48" **N24/M**



**C2 R10 V2** HEXAWORK W NATURAL 21 X 18.2 / 8" X 7" **P03/M**



**C2 R10 V4** HEXAWORK MIX 21 X 18.2 / 8" X 7" **N39/M**

### CARACTERÍSTICAS TÉCNICAS · TECHNICAL CHARACTERISTICS

- P** PORCELÁNICO/PORCELAIN TILES
- M** MATE/MATT
- R** RECTIFICADO/RECTIFIED
- M** MASA COLOREADA/COLORED BODY
- V2** VARIACION LEVE/SLIGHT VARIATION
- V4** VARIACION FUERTE/SUBSTANTIAL VARIATION
- T** ESPESOR/THICKNESS: 10,5mm/0,41"



## OVERFLOW POOL / PISCINA DESBORDANTE



POOL EDGE HIGH THICKNESS  
WORK B BIANCO  
90 X 90/36" X 36" **K93/P**  
\* Espesor 20mm / thickness 0,8"

POOL EDGE HIGH THICKNESS  
WORK B CENERE  
90 X 90/36" X 36" **K93/P**  
\* Espesor 20mm / thickness 0,8"

POOL EDGE HIGH THICKNESS  
WORK B COAL  
90 X 90/36" X 36" **K93/P**  
\* Espesor 20mm / thickness 0,8"

POOL EDGE HIGH THICKNESS  
WORK B TAUPE  
90 X 90/36" X 36" **K93/P**  
\* Espesor 20mm / thickness 0,8"



BORDE DESBORDANTE WORK B BIANCO  
28 X 66.5 / 11" X 26" **K94/P**



BORDE DESBORDANTE WORK B CENERE  
28 X 66.5 / 11" X 26" **K94/P**



BORDE DESBORDANTE WORK B COAL  
28 X 66.5 / 11" X 26" **K94/P**



BORDE DESBORDANTE WORK B TAUPE  
28 X 66.5 / 11" X 26" **K94/P**



REJILLA WORK B BIANCO  
24.5 X 24.5 / 9.4" X 9.4" **K57/P**



REJILLA WORK B CENERE  
24.5 X 24.5 / 9.4" X 9.4" **K57/P**



REJILLA WORK B COAL  
24.5 X 24.5 / 9.4" X 9.4" **K57/P**



REJILLA WORK B TAUPE  
24.5 X 24.5 / 9.4" X 9.4" **K57/P**



MEDIA CAÑA WORK B BIANCO  
4 X 33 / 1.5" X 13" **K29/P**



MEDIA CAÑA WORK B CENERE  
4 X 33 / 1.5" X 13" **K29/P**



MEDIA CAÑA WORK B COAL  
4 X 33 / 1.5" X 13" **K29/P**



MEDIA CAÑA WORK B TAUPE  
4 X 33 / 1.5" X 13" **K29/P**



ARISTA WORK B BIANCO  
4 X 33 / 1.5" X 13" **K29/P**



ARISTA WORK B CENERE  
4 X 33 / 1.5" X 13" **K29/P**



ARISTA WORK B COAL  
4 X 33 / 1.5" X 13" **K29/P**



ARISTA WORK B TAUPE  
4 X 33 / 1.5" X 13" **K29/P**



UÑA ARISTA WORK B BIANCO  
3 X 3 / 1.5" X 1.5" **K06/P**



UÑA ARISTA WORK B CENERE  
3 X 3 / 1.5" X 1.5" **K06/P**



UÑA ARISTA WORK B COAL  
3 X 3 / 1.5" X 1.5" **K06/P**



UÑA ARISTA WORK B TAUPE  
3 X 3 / 1.5" X 1.5" **K06/P**



UÑA CAÑA WORK B BIANCO  
4 X 4 / 1.5" X 1.5" **K06/P**



UÑA CAÑA WORK B CENERE  
4 X 4 / 1.5" X 1.5" **K06/P**



UÑA CAÑA WORK B COAL  
4 X 4 / 1.5" X 1.5" **K06/P**



UÑA CAÑA WORK B TAUPE  
4 X 4 / 1.5" X 1.5" **K06/P**



PELDAÑO RECTO WORK W NATURAL



BORDE DESBORDANTE WORK



HIGH THICKNESS/ESPESORADO



REJILLA WORK

### CARACTERÍSTICAS TÉCNICAS · TECHNICAL CHARACTERISTICS

- E** EXTRUSIONADO/EXTRUDED KLINKER
- M** MATE/MATT
- V3** VARIACION MODERADA/MODERATE VARIATION
- R11** ANTI-SLIP R11
- (DCOF) >0.50**
- C3** CLASE 3/CLASS 3
- ANTI-SLIP BAREFOOT A+B+C**

- DORSO ESTRIADO EN COLA DE MILANO. DOVE TAIL PROFILE.**
- JUNTA RECOMENDADA 5 MM. RECOMMENDED JOINT BETWEEN PIECES 5 MM.**





# Work

## BASES

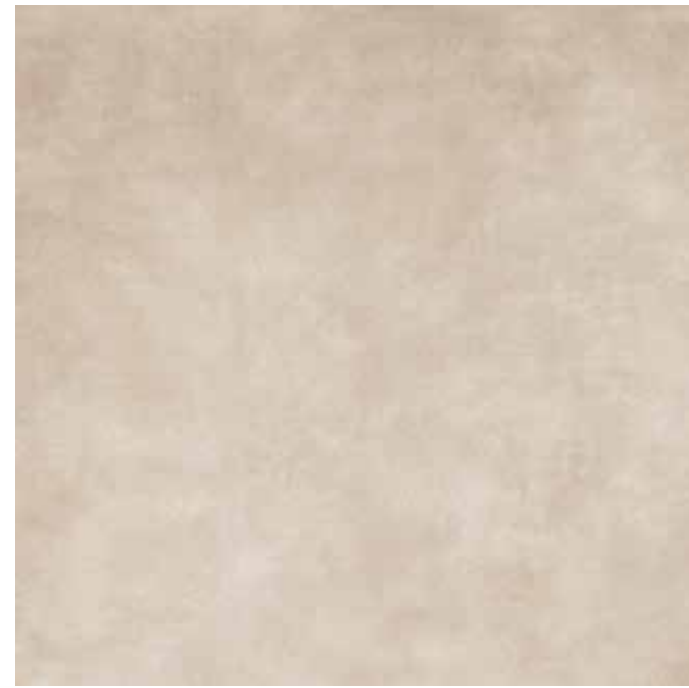

**C2 R10 V3** WORK B TAUPE RECT.  
120 X 120 / 48" X 48" **P08/M**



**V3** WORK B TAUPE RECT.  
90 X 90 / 36" X 36" **P09/M**

**C3 R11 V3** ANTI-SLIP WORK B TAUPE RECT.  
90 X 90 / 36" X 36" **P18/M**

**C3 R11 V3** HIGH THICKNESS WORK B TAUPE RECT.  
90 X 90 X 2 / 36" X 36" X 0,8" **N05/M**

\* Espesor 20mm / thickness 0,8"



**V3** WORK B TAUPE RECT.  
60 X 120 / 24" X 48" **P11/M**

**C3 R11 V3** ANTI-SLIP WORK B TAUPE RECT.  
60 X 120 / 24" X 48" **P01/M**



**V3** WORK B TAUPE RECT.  
60 X 60 / 24" X 24" **P16/M**

**C3 R11 V3** ANTI-SLIP WORK B TAUPE RECT.  
60 X 60 / 24" X 24" **P02/M**



**V3** MOSAICO WORK TAUPE  
30X30 (5X5) / 12"X12" **K01/P**

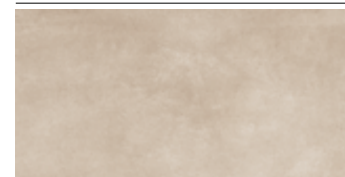

**V3** WORK B TAUPE RECT.  
30 X 60 / 12" X 24" **P16/M**

**C3 R11 V3** ANTI-SLIP WORK B TAUPE RECT.  
30 X 60 / 12" X 24" **P02/M**



**C2 R10 V3** HEXAWORK B TAUPE  
21 X 18.2 / 8" X 7" **P03/M**

### CARACTERÍSTICAS TÉCNICAS · TECHNICAL CHARACTERISTICS

**P** PORCELÁNICO/PORCELAIN TILES

**M** MATE/MATT

**MASA COLOREADA/COLORED BODY**

**ESPEJOR/THICKNESS:**  
10,5mm/0,41"  
90X90 - 10mm/0,39"  
90X90 - 20mm/0,79"

## BASES

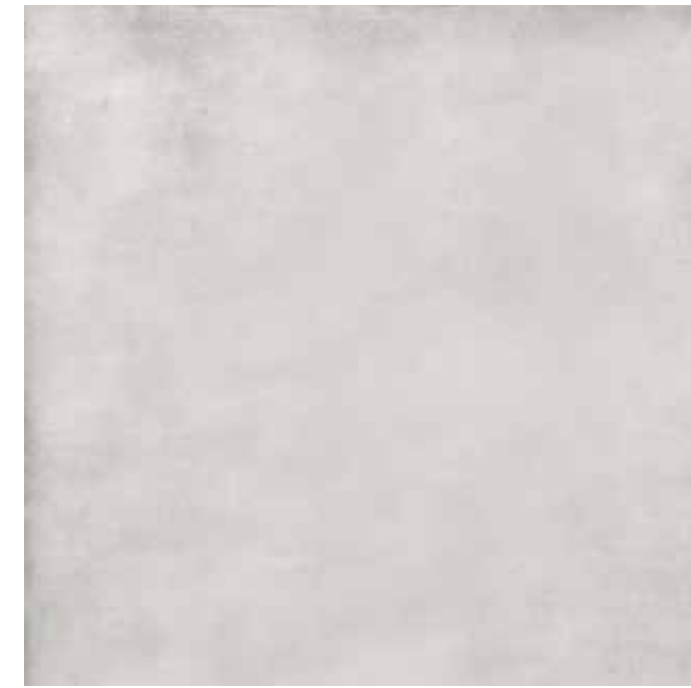

**C2 R10 V3** WORK B BIANCO RECT.  
120 X 120 / 48" X 48" **P08/M**



**V3** WORK B BIANCO RECT.  
90 X 90 / 36" X 36" **P09/M**

**C3 R11 V3** ANTI-SLIP WORK B BIANCO RECT.  
90 X 90 / 36" X 36" **P18/M**

**C3 R11 V3** HIGH THICKNESS WORK B BIANCO RECT.  
90 X 90 X 2 / 36" X 36" X 0,8" **N05/M**

\* Espesor 20mm / thickness 0,8"



**V3** WORK B BIANCO RECT.  
60 X 120 / 24" X 48" **P11/M**

**C3 R11 V3** ANTI-SLIP WORK B BIANCO RECT.  
60 X 120 / 24" X 48" **P01/M**



**V3** WORK B BIANCO RECT.  
60 X 60 / 24" X 24" **P16/M**

**C3 R11 V3** ANTI-SLIP WORK B BIANCO RECT.  
60 X 60 / 24" X 24" **P02/M**



**V3** MOSAICO WORK BIANCO  
30X30 (5X5) / 12"X12" **K01/P**



**C2 R10 V3** HEXAWORK B BIANCO  
21 X 18.2 / 8" X 7" **P03/M**

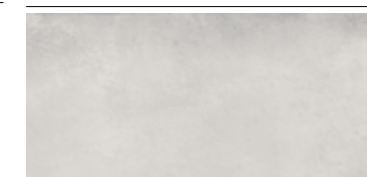

**V3** WORK B BIANCO RECT.  
30 X 60 / 12" X 24" **P16/M**

**C3 R11 V3** ANTI-SLIP WORK B BIANCO RECT.  
30 X 60 / 12" X 24" **P02/M**



# Work

## BASES

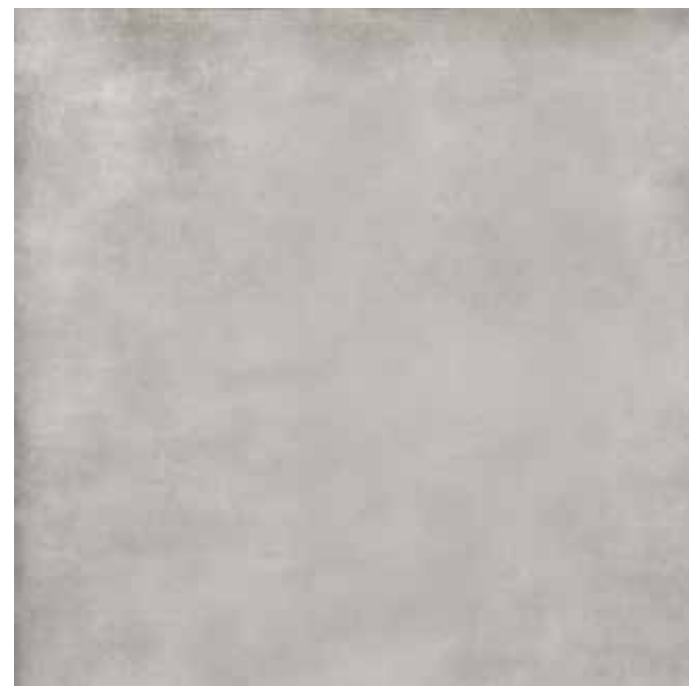

**C2 R10 V3** WORK B CENERE RECT.  
120 X 120 / 48" X 48" **P08/M**



**V3** WORK B CENERE RECT.  
90 X 90 / 36" X 36" **P09/M**

**C3 R11 V3** ANTI-SLIP WORK B CENERE RECT.  
90 X 90 / 36" X 36" **P18/M**

**C3 R11 V3** HIGH THICKNESS WORK B CENERE RECT.  
90 X 90 X 2 / 36" X 36" X 0,8" **N05/M**

\* Espesor 20mm / thickness 0,8"



**V3** WORK B CENERE RECT.  
60 X 120 / 24" X 48" **P11/M**

**C3 R11 V3** ANTI-SLIP WORK B CENERE RECT.  
60 X 120 / 24" X 48" **P01/M**



**V3** WORK B CENERE RECT.  
60 X 60 / 24" X 24" **P16/M**

**C3 R11 V3** ANTI-SLIP WORK B CENERE RECT.  
60 X 60 / 24" X 24" **P02/M**



**V3** MOSAICO WORK CENERE  
30X30 (5X5) / 12"X12" **K01/P**

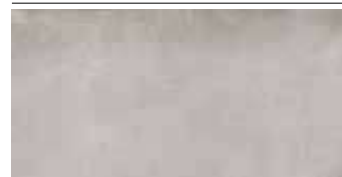

**V3** WORK B CENERE RECT.  
30 X 60 / 12" X 24" **P16/M**

**C3 R11 V3** ANTI-SLIP WORK B CENERE RECT.  
30 X 60 / 12" X 24" **P02/M**



**C2 R10 V3** HEXAWORK B CENERE  
21 X 18.2 / 8" X 7" **P03/M**

### CARACTERÍSTICAS TÉCNICAS · TECHNICAL CHARACTERISTICS

**P** PORCELÁNICO/PORCELAIN TILES

**M** MATE/MATT

**M** MASA COLOREADA/COLORED BODY

**H** ESPESOR/THICKNESS:  
10,5mm / 0,41"  
90X90 - 10mm / 0,39"  
90X90 - 20mm / 0,79"

## BASES

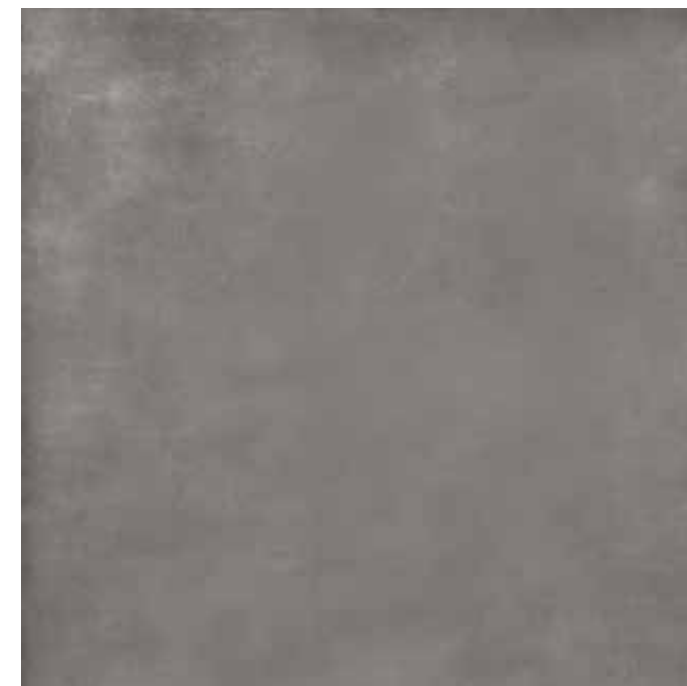

**C2 R10 V3** WORK B COAL RECT.  
120 X 120 / 48" X 48" **P08/M**



**V3** WORK B COAL RECT.  
90 X 90 / 36" X 36" **P09/M**

**C3 R11 V3** ANTI-SLIP WORK B COAL RECT.  
90 X 90 / 36" X 36" **P18/M**

**C3 R11 V3** HIGH THICKNESS WORK B COAL RECT.  
90 X 90 X 2 / 36" X 36" X 0,8" **N05/M**

\* Espesor 20mm / thickness 0,8"



**V3** WORK B COAL RECT.  
60 X 120 / 24" X 48" **P11/M**

**C3 R11 V3** ANTI-SLIP WORK B COAL RECT.  
60 X 120 / 24" X 48" **P01/M**



**V3** WORK B COAL RECT.  
60 X 60 / 24" X 24" **P16/M**

**C3 R11 V3** ANTI-SLIP WORK B COAL RECT.  
60 X 60 / 24" X 24" **P02/M**



**V3** MOSAICO WORK COAL  
30X30 (5X5) / 12"X12" **K01/P**



**C2 R10 V3** HEXAWORK B COAL  
21 X 18.2 / 8" X 7" **P03/M**

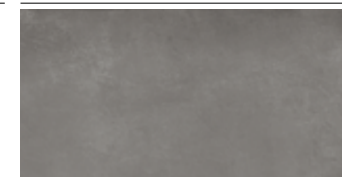

**V3** WORK B COAL RECT.  
30 X 60 / 12" X 24" **P16/M**

**C3 R11 V3** ANTI-SLIP WORK B COAL RECT.  
30 X 60 / 12" X 24" **P02/M**





**collections**

colecciones

PUBLIC POOLS / PISCINAS PÚBLICAS

**Dots**

144

**Grooved**

146



# Dots

## Overflow pool.

Dots collection is a covering for swimming pools with overflowing system , that gives perfect solutions for the most complicated areas of multi-use swimming pools and public sport facilities. Moreover, it guarantees optimum security.

Some of the benefits of this system are:

Omnidirectional anti-slipping. Homogeneous and safer compared with other grooved reliefs.

Easy laying and faster cleaning of the grout.

Easy and safe maintenance, thanks to the relief design.

## Piscina desbordante.

La colección Dots es un recubrimiento para piscinas, con sistema de coronación desbordante, que da óptimas soluciones a las zonas más complejas de piscinas polivalentes e instalaciones deportivas de uso público. Garantizando la máxima seguridad de manera homogénea.

Algunas ventajas de este sistema:

Antideslizamiento omnidireccional, homogéneo y más seguro, frente a otros relieves ranurados.

Fácil colocación y limpieza del rejuntado más rápida.

Mantenimiento rápido y seguro, debido al diseño del relieve.

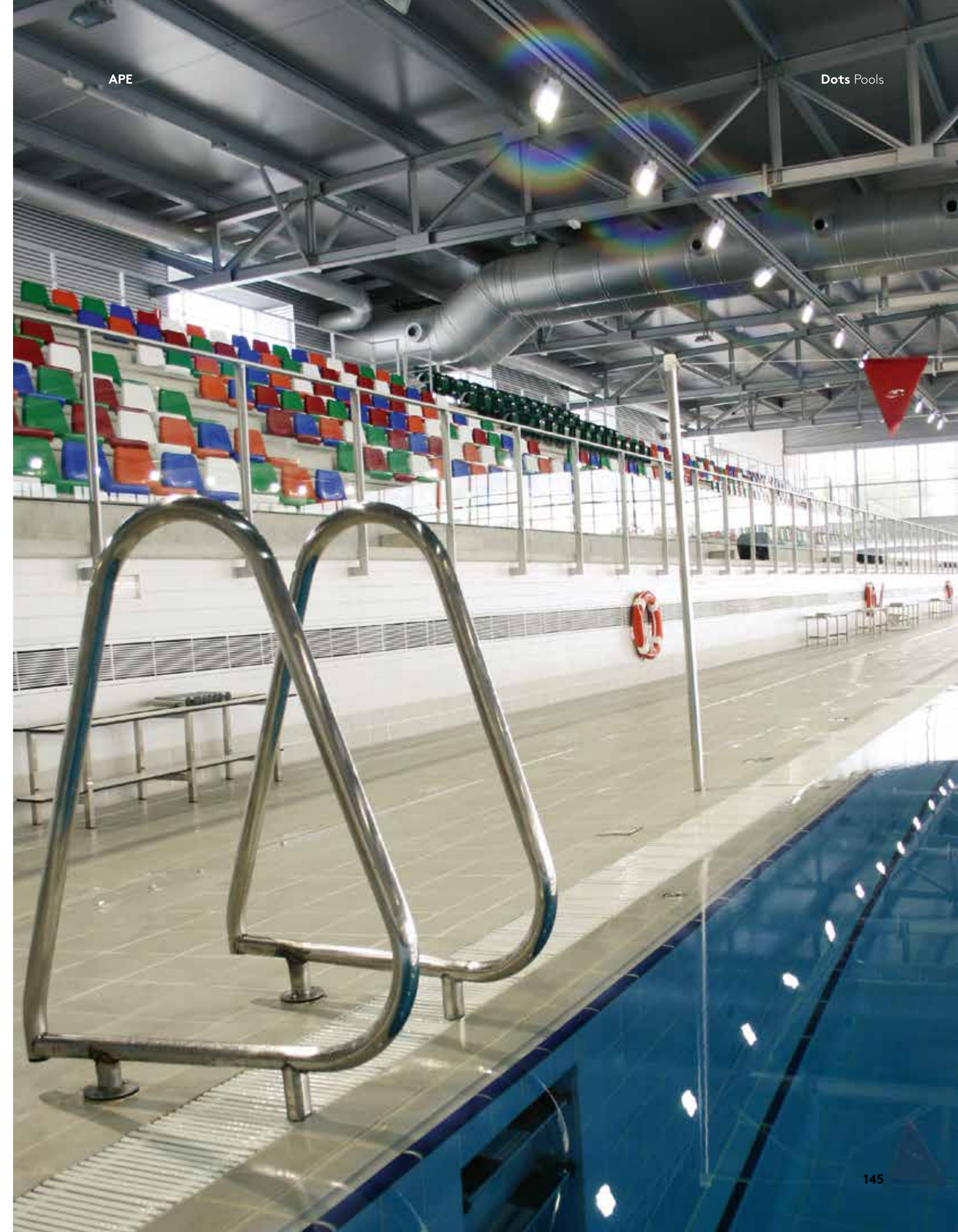



# Grooved

## Overflow pool.

The Finnish system with Grooved finish is the most used system for overflow pools in public facilities.

Multi-use swimming pools, communal swimming pools and public swimming pools. This system offers a series of benefits:

Excellent visibility.

Attenuation of the waves in competition swimming pools.

Water film with a larger surface area than the tank.

## Piscina desbordante.

El sistema finlandés con acabado Grooved es el sistema más utilizado para piscinas desbordantes en instalaciones de uso público.

Piscinas polivalentes, piscinas comunitarias e instalaciones deportivas de uso público. Este sistema ofrece una serie de ventajas:

Excelente visibilidad.

Atenuación del oleaje en vasos deportivos de competición.

Lámina de agua con superficie mayor que el vaso.





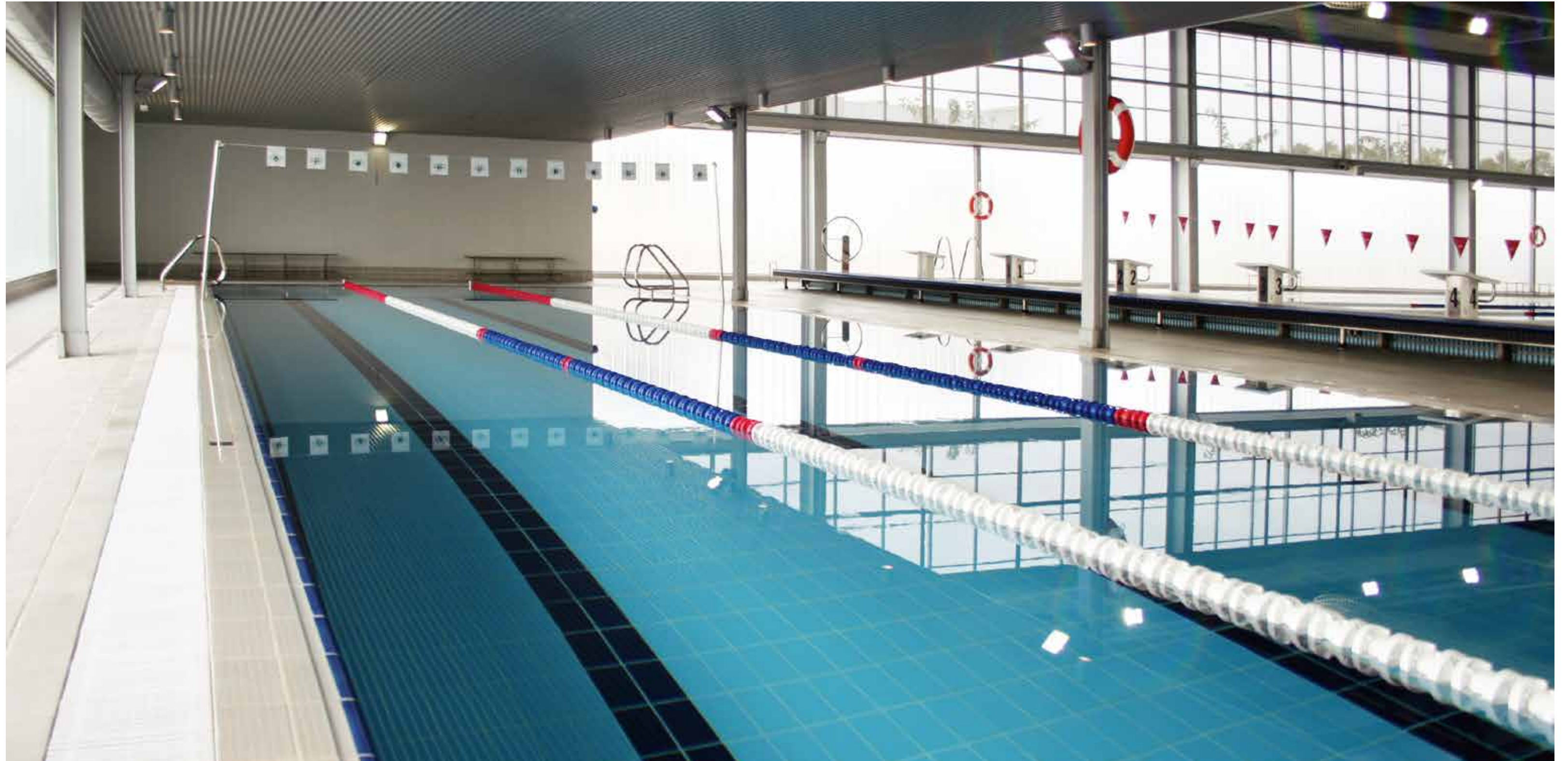



# Dots

## SPECIAL PIECES / PIEZAS ESPECIALES

### OVERFLOW POOL / PISCINA DESBORDANTE

#### AVAILABLE COLORS / COLORES DISPONIBLES

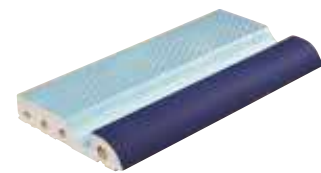

**420**  
BORDE DOTS  
12X24,5X2,6 / 5"X10"X1"  
(Azul) ● K92/P  
(Beige) ● K92/P  
(Blanco) ● K92/P  
(Perla) ● K92/P

(Azul / Marino) ●● K85/P  
(Beige / Marino) ●● K85/P  
(Blanco / Marino) ●● K85/P  
(Perla / Marino) ●● K85/P



**423**  
BORDE ÁNGULO EXTERIOR DOTS  
12X12X2,6 / 5"X5"X1,5" K60/P



**422**  
BORDE ÁNGULO INTERIOR DOTS  
12X12 / 5"X5" K60/P



**410**  
SOPORTE REJILLA DOTS  
13,5X24,5X3,5 / 5,3"X9,6"X1,4" K87/P  
ONLY / SOLO: ● Azul, ● Perla, ● Beige y ● Blanco.



**421**  
BORDE ESQUINA DOTS  
17X17 / 7,7"X7,7" K60/P

### OUTSIDE THE POOL / EXTERIOR DE LA PISCINA

#### AVAILABLE COLORS / COLORES DISPONIBLES

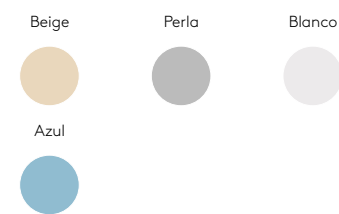

**401**  
BASE DOTS  
12X24,5X0,9 / 5"X10"X0,4" K44/P

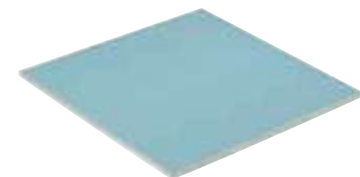

**402**  
BASE DOTS  
24,5X24,5X0,9 / 10"X10"X0,4" K19/P

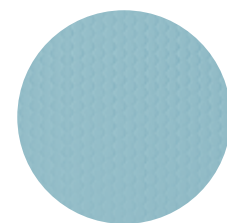

TEXTURE / TEXTURA



# Grooved

## SPECIAL PIECES / PIEZAS ESPECIALES

### OVERFLOW POOL / PISCINA DESBORDANTE

#### AVAILABLE COLORS / COLORES DISPONIBLES



**320**  
BORDE GROOVED  
12X24,5X2,6 / 5"X10"X1"  
(Azul) ● K92/P  
(Beige) ● K92/P  
(Blanco) ● K92/P  
(Perla) ● K92/P

(Azul / Marino) ●● K85/P  
(Beige / Marino) ●● K85/P  
(Blanco / Marino) ●● K85/P  
(Perla / Marino) ●● K85/P



**323**  
BORDE ÁNGULO EXTERIOR GROOVED  
12X12X2,6 / 5"X5"X1" K60/P



**322**  
BORDE ÁNGULO INTERIOR GROOVED  
12X12 / 5"X5" K60/P



**310**  
SOPORTE REJILLA GROOVED  
13,5X24,5X3,5 / 5,3"X9,6"X1,4" K87/P  
ONLY / SOLO: ● Azul, ● Perla, ● Beige y ● Blanco.



**321**  
BORDE ESQUINA GROOVED  
17X17 / 7,7"X7,7" K60/P

### OUTSIDE THE POOL / EXTERIOR DE LA PISCINA

#### AVAILABLE COLORS / COLORES DISPONIBLES

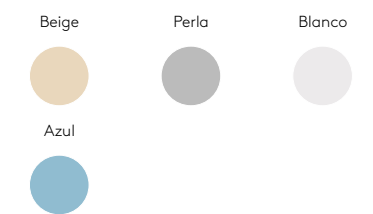

**301**  
BASE GROOVED  
12X24,5X0,9 / 5"X10"X0,4" K44/P



TEXTURE / TEXTURA





SPECIAL PIECES / PIEZAS ESPECIALES

INSIDE THE POOL / DENTRO DE LA PISCINA

AVAILABLE COLORS / COLORES DISPONIBLES

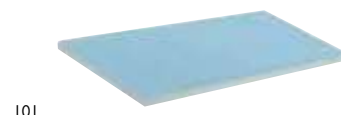
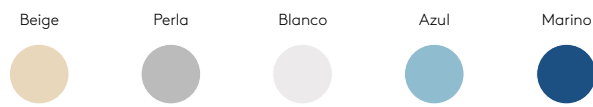

101  
BASE LISA  
12X24,5X0,9 / 5"X10"X0,4"  
● Marino K43/P  
K31/P



201  
BASE ANTI-SLIP SUAVE  
12X24,5X0,9 / 5"X10"X0,4"  
ONLY / SOLO: ● Azul y ● Blanco. K96/P  
● Marino K97/P



SOLUTIONS FOR CORNERS AND ANGLES / SOLUCIONES PARA ESQUINAS Y ÁNGULOS

AVAILABLE COLORS / COLORES DISPONIBLES

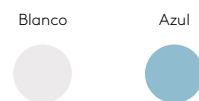

186  
ARISTA L  
24,5 X 8 CM  
10" X 3" - R6 CM K24/P



183  
ÁNGULO EXTERIOR ARISTA L  
12 X 8 X 8 CM  
5" X 3" X 3" K15/P



185  
MEDIA CAÑA L  
24,5 X 8 CM  
10" X 3" - R6 CM K24/P



184  
ÁNGULO INTERIOR ARISTA L  
12 X 8 X 8 CM  
5" X 3" X 3" K15/P



187  
UÑA L  
8 X 8 CM  
3" X 3" - R6 CM K06/P



188  
UÑA ARISTA L  
8 X 8 CM  
3" X 3" - R6 CM K06/P

AVAILABLE COLORS / COLORES DISPONIBLES

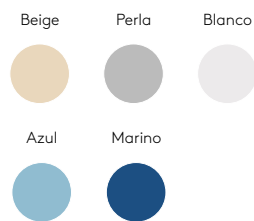

176  
ARISTA  
24,5 X 3 CM  
10" X 1,2" - R3 CM  
● Marino K24/P  
K29/P



175  
MEDIA CAÑA  
24,5 X 4 CM  
10" X 1,5" - R3 CM  
● Marino K24/P  
K29/P



177  
UÑA  
4 X 4 CM  
1,5" X 1,5" - R3 CM K06/P

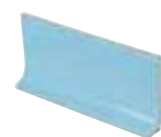

170  
ZÓCALO SANITARIO CON ESCOCIA  
ESMALTADO  
12 X 24,5 X 3,5 CM  
5" X 10" X 1,4"  
● Marino K18/P  
K89/P



172  
ÁNGULO EXTERIOR ARISTA  
12 X 4,75  
5" X 2" - R3 CM  
● Marino K48/P  
K62/P



171  
ÁNGULO INTERIOR ARISTA  
12 X 4,75  
5" X 2" - R3 CM  
● Marino K48/P  
K62/P



178  
UÑA ARISTA  
3 X 3 CM  
1,2" X 1,2" - R3 CM K06/P

SPECIAL PIECES / PIEZAS ESPECIALES

Solutions in corners and level changes in:  
Walking access stairs · Resting step · Walls · Internal/external benches · Built-in stairs.

Soluciones en esquinas y cambios de plano en:  
Escaleras de acceso a pie · Descansillos · Muretes · Bancadas interiores y exteriores · Escaleras empotradas.

AVAILABLE COLORS / COLORES DISPONIBLES

smooth / liso



soft anti-slip / anti-slip suave

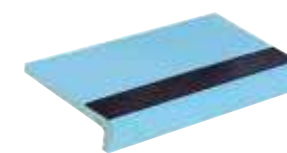

155  
ANGULAR LISO  
12X24,5X3 / 5"X10"X1,2"  
● Azul, y ● Blanco. K35/P  
● Marino K89/P

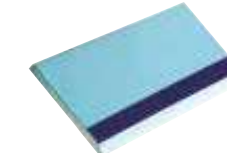

150  
ROMO LISO  
12X24,5X0,9 / 5"X10"X0,4"  
● Azul, y ● Blanco. K90/P  
● Marino K88/P

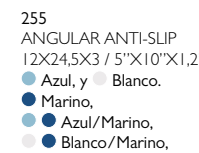

255  
ANGULAR ANTI-SLIP  
12X24,5X3 / 5"X10"X1,2"  
● Azul, y ● Blanco. K35/P  
● Marino, K89/P  
● Azul/Marino, K89/P  
● Blanco/Marino, K89/P

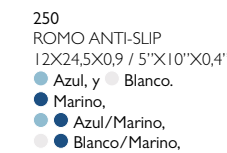

250  
ROMO ANTI-SLIP  
12X24,5X0,9 / 5"X10"X0,4"  
● Azul, y ● Blanco. K90/P  
● Marino, K88/P  
● Azul/Marino, K88/P  
● Blanco/Marino, K88/P

soft anti-slip / anti-slip suave



256  
ESQUINA EXTERIOR ANGULAR ROMO  
12X12X3 / 5"X5"X1,2" K65/P

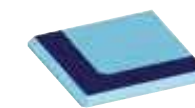

252  
ESQUINA EXTERIOR ROMO  
12X12X0,9 / 5"X5"X0,4" K65/P



257  
ESQUINA EXTERIOR  
ANGULAR ARISTA  
12X12X3 / 5"X5"X1,2" K65/P

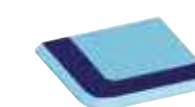

253  
ESQUINA EXTERIOR  
ROMO ARISTA  
12X12X0,9 / 5"X5"X0,4" K65/P

soft anti-slip / anti-slip suave

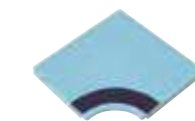

251  
ESQUINA INTERIOR  
17,5X17,5X0,9 / 6,7"X6,7"X0,4" K65/P

soft anti-slip / anti-slip suave





SPECIAL PIECES / PIEZAS ESPECIALES

OVERFLOW CHANNEL / CANALETA

AVAILABLE COLORS / COLORES DISPONIBLES

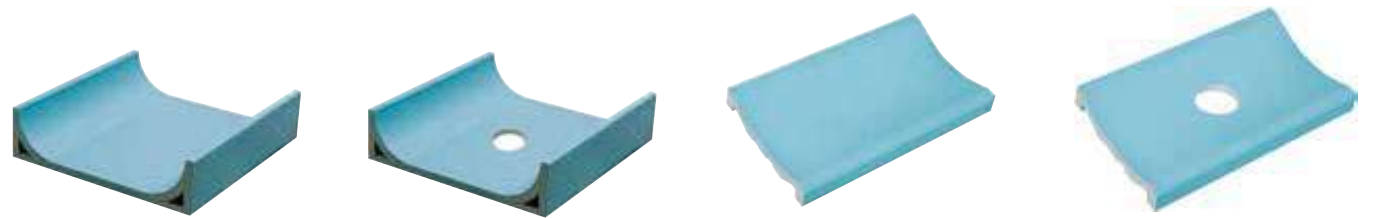

114  
CANALETA  
24,5 X 24,5 X 6,5 CM  
10" X 10" X 2,6"  
ONLY / SOLO:  
● Azul y ● Blanco  
K15/P

115  
CANALETA SUMIDERO  
24,5 X 24,5 X 6,5 CM - 10" X 10" X 2,6"  
Ø 50-65 MM  
ONLY / SOLO:  
● Azul y ● Blanco  
K75/P

112  
CANALETA  
15 X 24,5 X 3,5 CM  
6" X 10" X 1,4"  
K46/P

113  
CANALETA SUMIDERO  
15 X 24,5 X 6,5 CM - 6" X 10" X 1,4"  
Ø 50-65 MM  
K65/P

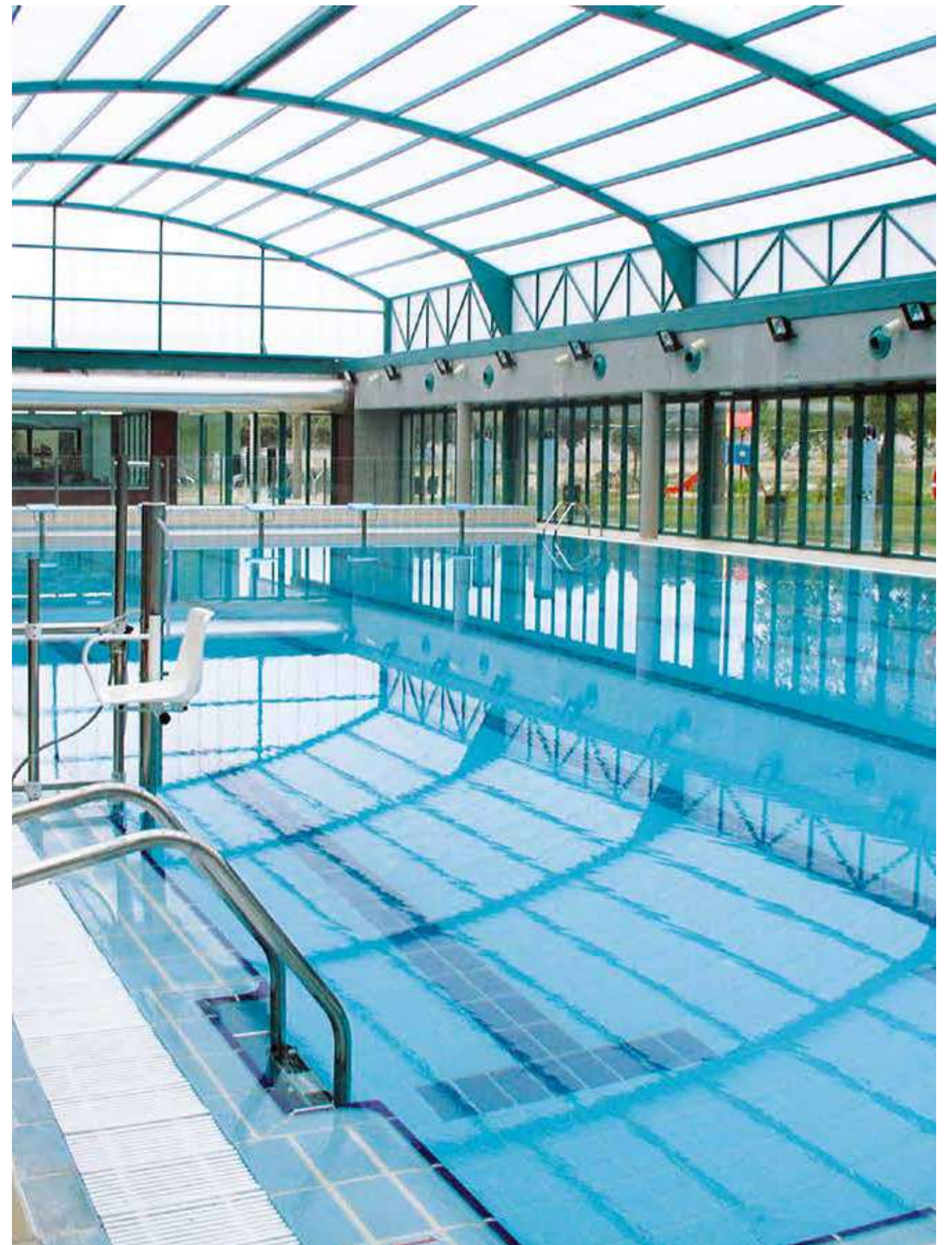





# technical information

información técnica



## CERAMIC GRATING / REJILLA CERAMICA

24,5x24,5/9,4"x9,4"  
EXTRUSIONADO/EXTRUDED KLINKER

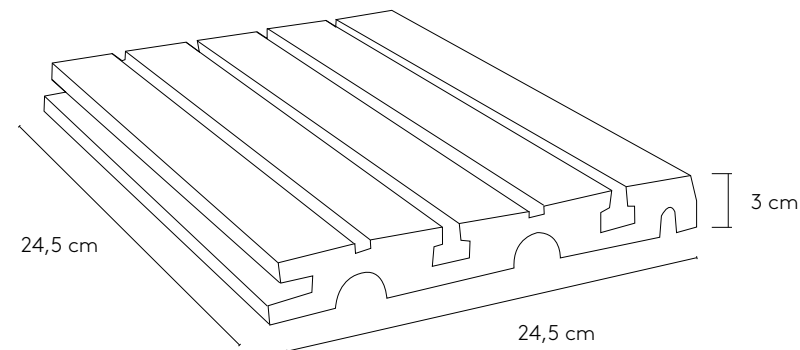

### Exclusive ceramic grating for overflow pools.

The mesh strainer system for infinity pools allows the user to create overflow pools, giving a perfect solution to the most complex areas of multi-use swimming pools and public sport facilities and guaranteeing optimum safety in a homogeneous manner.

Some of the benefits of the system:

Omnidirectional anti-slipping. Homogeneous and safer compared with other grooved reliefs.

Easy laying and faster cleaning of the grout.

Easy and safe maintenance, thanks to the relief design.

Regarding the installation of the grids for the pool overflows, the most appropriate installation is to invert each piece 180° relative to the previous one. This way, the more superficial grooves in one piece pour the water into the deeper ones in the adjacent piece and improve drainage. (Image **A**)

It is also possible to lay all the pieces in the same direction, achieving a more aesthetic result. In this case it is essential to respect a separation between the pieces to allow the water to fall through the gutter that is generated in the intermediate space. (Image **B**)

### Rejillas exclusivas para piscinas desbordantes.

El sistema de rejilla para piscinas desbordantes permite realizar piscinas de coronación desbordante, que da óptimas soluciones a las zonas más complejas de piscinas polivalentes e instalaciones deportivas de uso público, garantizando la máxima seguridad de manera homogénea.

Algunas ventajas de este sistema:

Antideslizamiento omnidireccional, homogéneo y más seguro, frente a otros relieves ranurados.

Fácil colocación y limpieza del rejuntado más rápida.

Mantenimiento rápido y seguro, debido al diseño del relieve.

En lo relativo la instalación de las rejillas para los rebosaderos de las piscinas, la colocación más adecuada es invertir cada pieza 180° respecto a la anterior. De esta forma los surcos más superficiales de una pieza vierten el agua a los más profundos de la pieza adyacente y mejoran el desagüe. (Imagen **A**)

También es posible colocar todas las piezas en el mismo sentido consiguiendo un resultado más estético. En este caso es imprescindible respetar una separación entre pieza y pieza para facilitar la caída del agua por la canaleta que se genera en el espacio intermedio. (Imagen **B**)

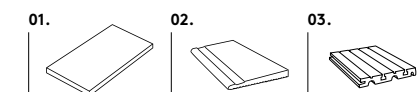

01. OXFORD C3 PURE 33X66,5/13"X26"  
02. BORDE DESBORDANTE OXFORD PURE 28X66,5/11"X26"  
03. REJILLA OXFORD PURE 24,5X24,5/9,4"X9,4"

A.

B.





**OVERFLOW EDGE / BORDE DESBORDANTE**

28x66,5 / 11"x26"  
EXTRUSIONADO/EXTRUDED KLINKER

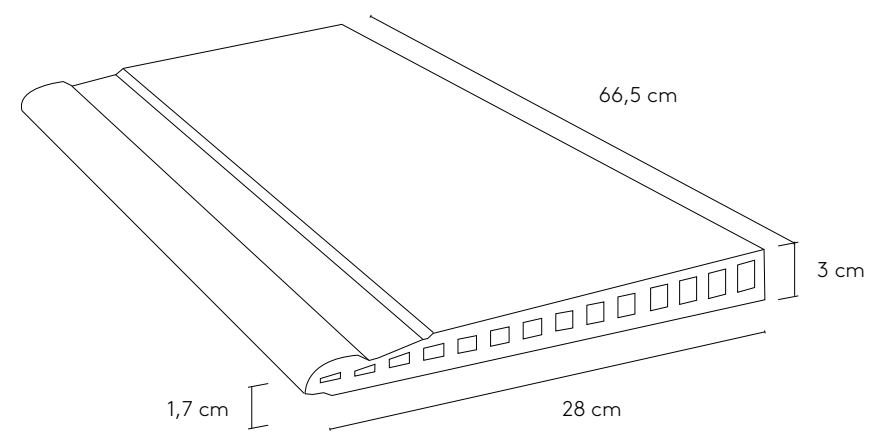

The overflow edge is a special extruded stoneware piece with a light tilt. It is designed so that the tiling arrives to the end of the swimming pool.

The overflow edge with a mesh strainer guarantees excellent results, not only from a practical perspective, draining the water, but also from an aesthetic perspective, creating an increase of the perception of the swimming pool size.

El borde desbordante es una pieza especial de gres extrusionado que tiene una ligera inclinación y que está diseñada para que el solado llegue hasta el final de la piscina.

El borde desbordante con rejilla garantiza excelentes resultados, tanto desde un punto de vista práctico, permitiendo la recogida y drenaje del agua, como desde un punto de vista estético creando un aumento en la percepción del tamaño de la piscina.

**MAINTENANCE**

Easy cleaning

With a minimum effort APE's swimming pools are perfectly maintained. In addition, porcelain stoneware is not susceptible to microbial formations, so you can swim peacefully.

**MANTENIMIENTO**

Limpieza fácil

Con un mínimo esfuerzo las piscinas de APE se mantienen perfectas. Además el gres porcelánico no es susceptible de formaciones microbianas, así que su tranquilidad será total.

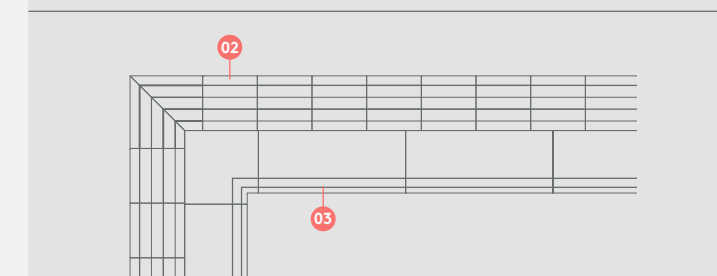
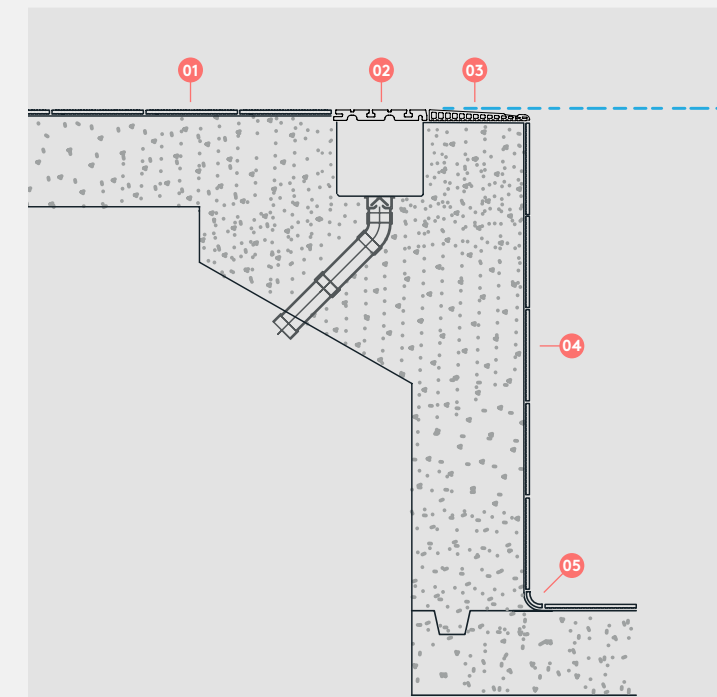

- |           |                   |               |
|-----------|-------------------|---------------|
| <b>01</b> | BASE              | BASE          |
| <b>02</b> | REJILLA           | GRATING       |
| <b>03</b> | BORDE DESBORDANTE | OVERFLOW EDGE |
| <b>04</b> | BASE LISA         | FLAT BASE     |
| <b>05</b> | MEDIA CAÑA        | COVE          |





### STAIR TREAD STRAIGHT / PELDAÑO RECTO

33x120x3 / 13"x48"x1"  
EXTRUSIONADO/EXTRUDED KLINKER

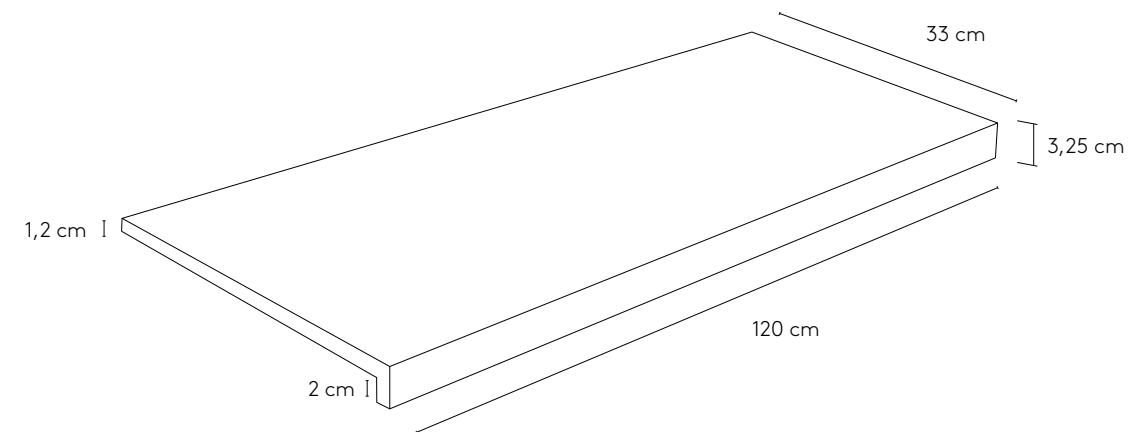

Our collections include straight steps for a more linear, minimalist aesthetic finish. Moreover, the steps are also used for the swimming pool stairs, so that the result becomes homogeneous.

One of the advantages of this system is that it is more efficient regarding cleaning and energy consumption. In addition, it needs less space in relation to an infinity pool, as the latter needs a compensation tank or a channeling able to store between 5% and 10% of the total of the volume of the swimming pool for the replenishment of water.

Nuestras colecciones incluyen peldaños rectos que permiten un acabado estético más lineal y minimalista. Además los peldaños se usan también en las escaleras interiores de la piscina, por lo que se homogeneiza el resultado.

Entre las ventajas de este sistema es que es más eficiente en lo relativo a limpieza y consumo energético. Además precisa menor espacio respecto a una piscina desbordante, ya que esta precisa un depósito de compensación o espacios de canalización suficientes para almacenar entre un 5 y un 10% del total del volumen de la piscina para la reposición de agua.

#### SECURITY

No slips

APE's anti-slip technology provides maximum safety in the tank, on the edge and on the perimeter of the swimming pool. It is visually pleasing and easy-to-clean.

#### SEGURIDAD

Sin resbalones

Los antideslizantes de APE aportan la máxima seguridad, tanto en la zona de playa como en el borde y el vaso de la piscina. Son agradables y fáciles de limpiar.

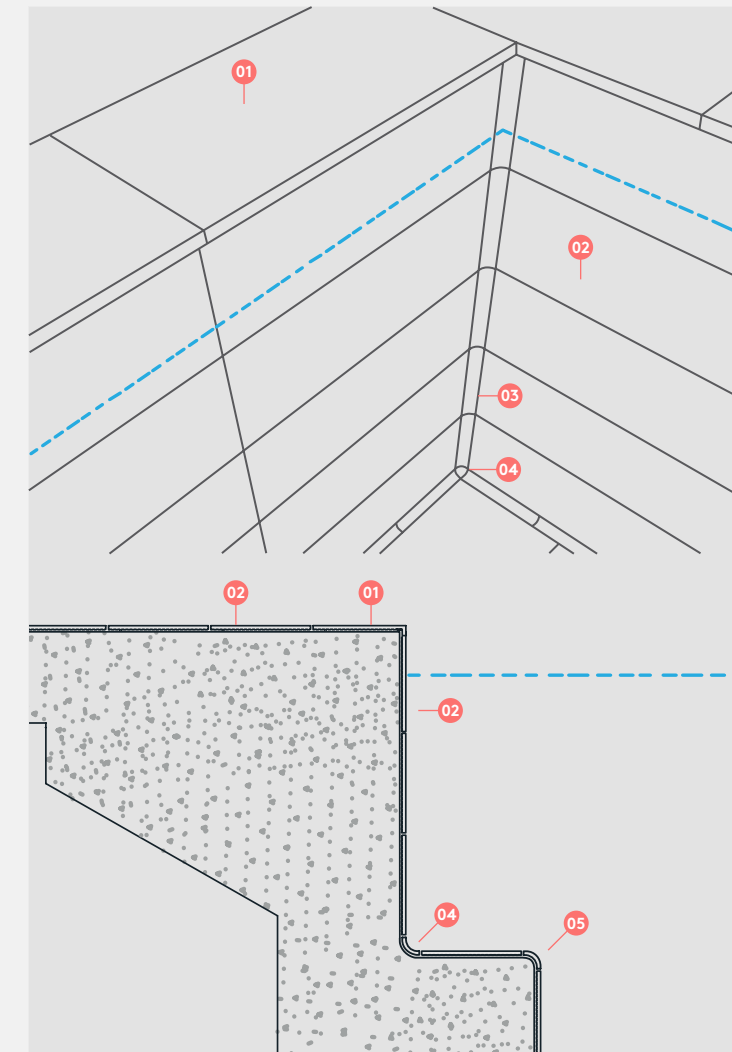

01	PELDAÑO RECTO	STAIR TREAD STRAIGHT
02	BASE	BASE
03	MEDIA CAÑA	COVE
04	UÑA	COVE CORNER TRIM
05	ARISTA	TRIM





**TRADITIONAL POOL/PISCINA TRADICIONAL**

28x66,5x4,5/11"x26"x2"  
EXTRUSIONADO/EXTRUDED KLINKER

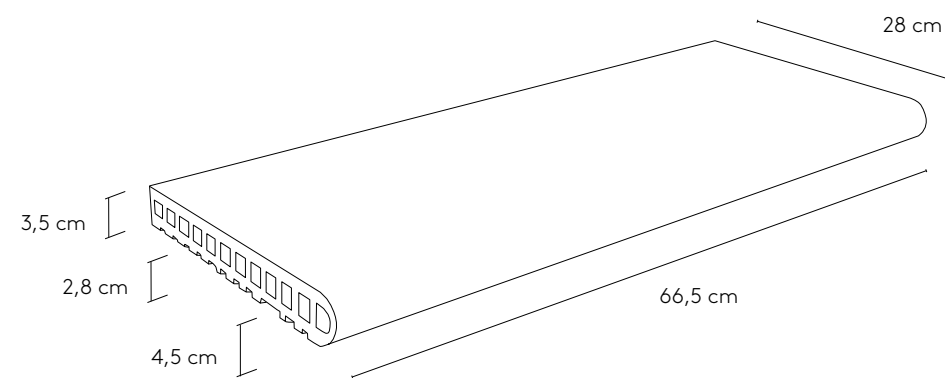

Traditional pools can be topped with rounded swimming pool edges.

A classic piece with the attributes of extrusion.

Las piscinas tradicionales pueden ser coronadas con bordes de piscina redondeadas.

Una pieza clásica con las propiedades del extrusionado.

**IT LASTS FOREVER**  
The perfect swimming pool.

Every summer your swimming pool will be working as well as the first day. Since a swimming pool is a dream, at APE we want to help you make it come true.

**ES PARA SIEMPRE**  
La piscina perfecta.

Cada verano tu piscina estará funcionando tan bien como el primer día. Porque una piscina es un sueño y en APE queremos ayudarte a hacerlo realidad.

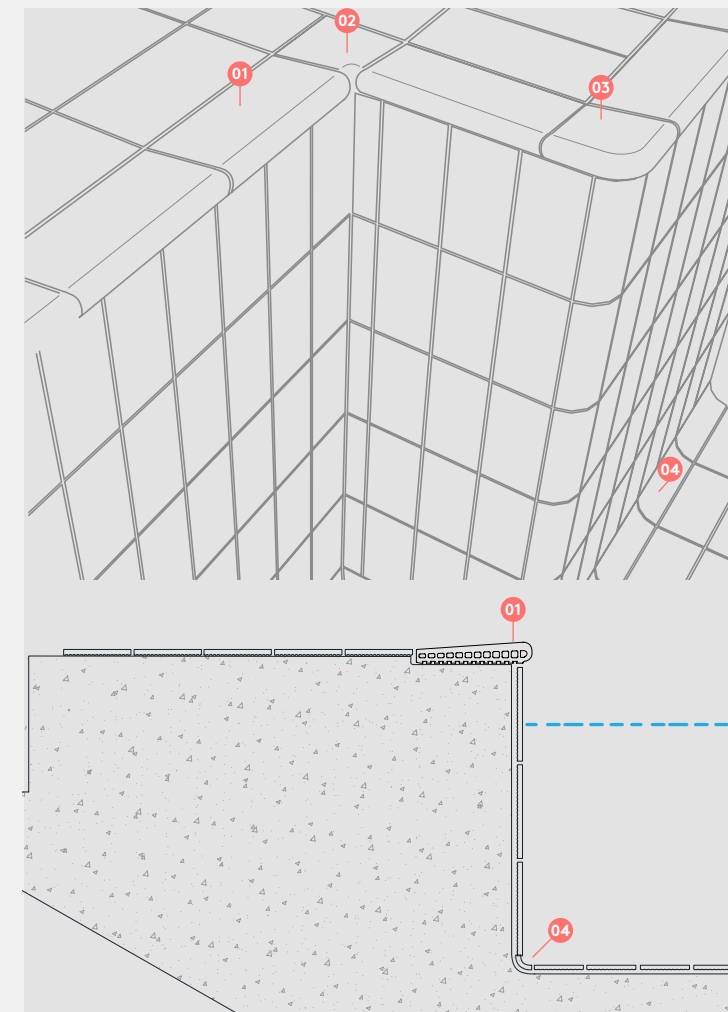

- |    |                         |                      |
|----|-------------------------|----------------------|
| 01 | BORDE PISCINA           | POOL BORDER EDGE     |
| 02 | ÁNGULO INTERIOR PISCINA | POOL INTERIOR CORNER |
| 03 | ÁNGULO EXTERIOR PISCINA | POOL EXTERIOR ANGLE  |
| 04 | MEDIA CAÑA              | COVE                 |





### TRADITIONAL POOL/PISCINA TRADICIONAL

45x75x3 / 18"x30"x1"  
EXTRUSIONADO/EXTRUDED KLINKER

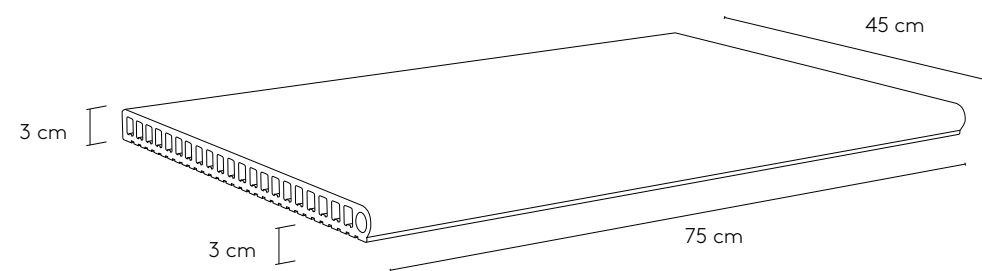

The skimmer system can be installed with a rounded edge or a straight step.

The skimmer system is the classic system in which the water surface is 20cm below the edge of the swimming pool. It is equipped with a less complex filtration system, so the economic investment is lower.

El sistema skimmer puede instalarse con un borde redondeado o con un peldaño recto.

El sistema de skimmer es el sistema clásico en el que la superficie del agua está a unos 20 cm por debajo del borde de la piscina, equipado con un sistema de filtrado menos complejo, por lo que reduce la inversión económica en esta instalación.

#### RESISTANCE

The material that never deteriorates.

It does not alter its properties nor change its color after exposure to sunlight. It is resistant to contact with water and chemical products for filtration. It does not break or crack.

#### RESISTENCIA

El material que nunca se estropea.

No se altera ni cambia de color con la radiación del sol. No le afecta el contacto con el agua ni los productos químicos para la depuración. No se rompe ni se agrieta.

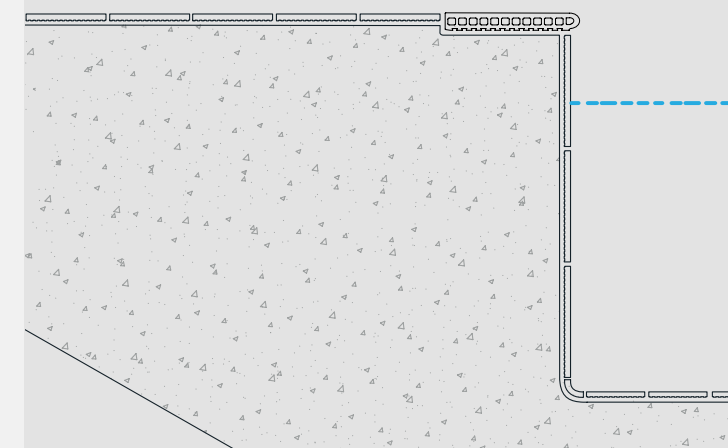
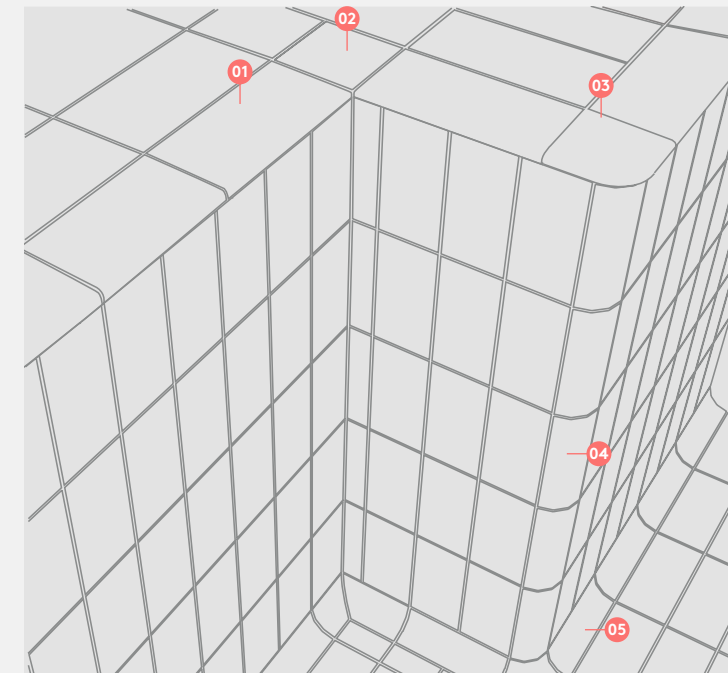

- |    |                         |                      |
|----|-------------------------|----------------------|
| 01 | BORDE PISCINA           | POOL BORDER EDGE     |
| 02 | ÁNGULO INTERIOR PISCINA | POOL INTERIOR CORNER |
| 03 | ÁNGULO EXTERIOR PISCINA | POOL EXTERIOR ANGLE  |
| 04 | ARISTA                  | TRIM                 |
| 05 | MEDIA CAÑA              | COVE                 |





**PUBLIC POOLS EDGE / BORDE PISCINAS PUBLICAS**

EXTRUSIONADO/EXTRUDED KLINKER

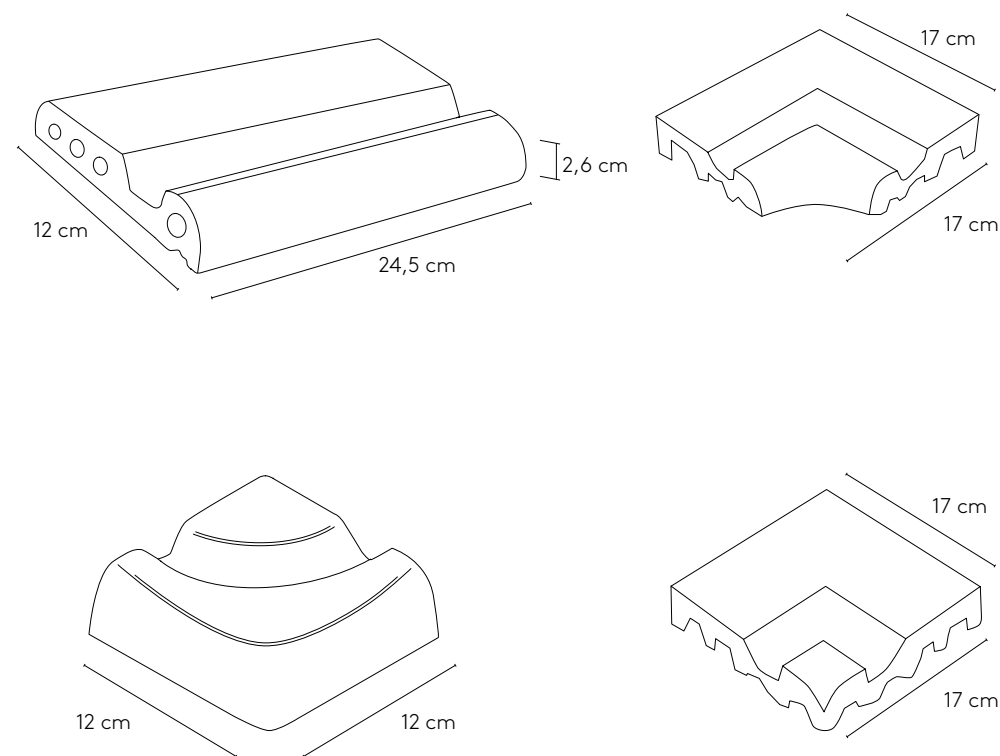

APE dedicates a product line for public swimming pools with infinity edge and stands out for its hygienic and aesthetic advantages.

Infinity pools are those where the water overflows the perimeter and is gathered by a groove that runs around the swimming pool. This channel filters the water and keeps it always clean.

APE dedica una línea de producto para piscinas de uso público que habitualmente optan por sus ventajas higiénicas y estéticas por un sistema desbordante.

Las piscinas desbordantes son aquellas en las que el agua se desborda por el perímetro de la piscina y es recogida en una canaleta que bordea el vaso. En este canal se filtra el agua consiguiendo mantenerla siempre limpia

**SECURITY**

No slips

APE's anti-slipping systems allow for maximum safety in the tank, on the edge and around the perimeter of the swimming pool. They are visually pleasing and easy-to-clean.

**SEGURIDAD**

Sin resbalones

Los antideslizantes de APE aportan la máxima seguridad, tanto en la zona de playa como en el borde y el vaso de la piscina. Son agradables y fáciles de limpiar.

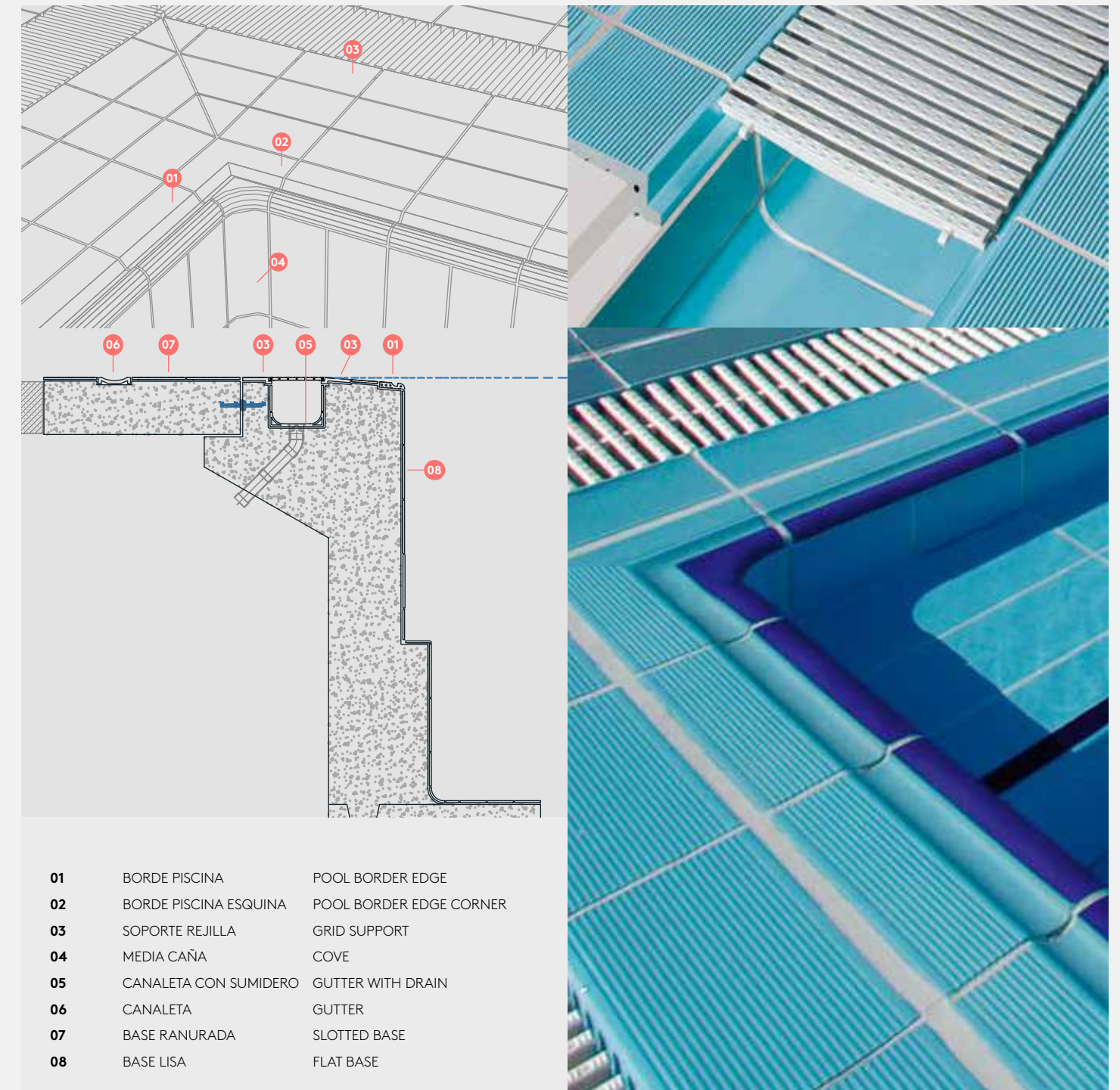

- |    |                       |                         |
|----|-----------------------|-------------------------|
| 01 | BORDE PISCINA         | POOL BORDER EDGE        |
| 02 | BORDE PISCINA ESQUINA | POOL BORDER EDGE CORNER |
| 03 | SOPORTE REJILLA       | GRID SUPPORT            |
| 04 | MEDIA CAÑA            | COVE                    |
| 05 | CANALETA CON SUMIDERO | GUTTER WITH DRAIN       |
| 06 | CANALETA              | GUTTER                  |
| 07 | BASE RANURADA         | SLOTTED BASE            |
| 08 | BASE LISA             | FLAT BASE               |



## SPECIAL PIECES PUBLIC SWIMMING POOLS / PIEZAS ESPECIALES PISCINAS PÚBLICAS

Solutions in corners and level changes in:  
Walking access stairs · Resting step · Walls · Internal/external benches · Built-in stairs.

Soluciones en esquinas y cambios de plano en:  
Escaleras de acceso a pie · Descansillos · Muretes · Bancadas interiores y exteriores · Escaleras empotradas.

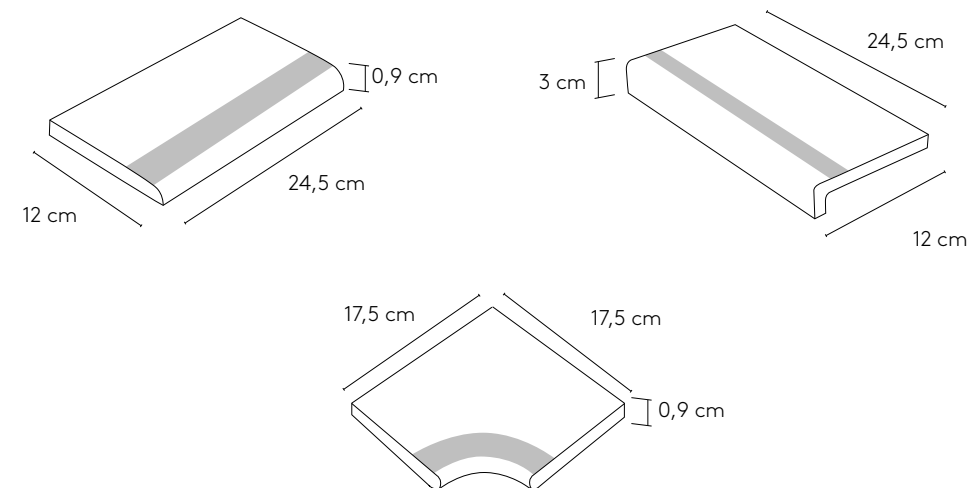

The tank is the structure that contains the water. The interior covering is used to protect and prevent leaks. This covering has become a very important decorative element.

Our office consists of a series of pieces that allow us to cover the tank and give solutions for corners and change of planes.

El vaso de la piscina es la estructura que contiene el agua. El recubrimiento interior sirve para proteger y evitar las fugas de agua pero también se ha convertido en un elemento decorativo de gran importancia.

En nuestra oferta contamos con una serie de piezas que nos permiten revestir el vaso de la piscina y dar soluciones para aristas o cambios de plano

Many special pieces help to coat the swimming pool's tank and guarantee that it functions properly. In order to obtain an interesting aesthetic finish, these pieces maintain continuity with the swimming pool's crowning and tiling.

Son muchas las piezas especiales que ayudan a revestir el vaso de la piscina y aseguran su buen funcionamiento. Para conseguir un acabado estético interesante estas mantienen continuidad con los sistemas de coronación y el solado de la piscina.

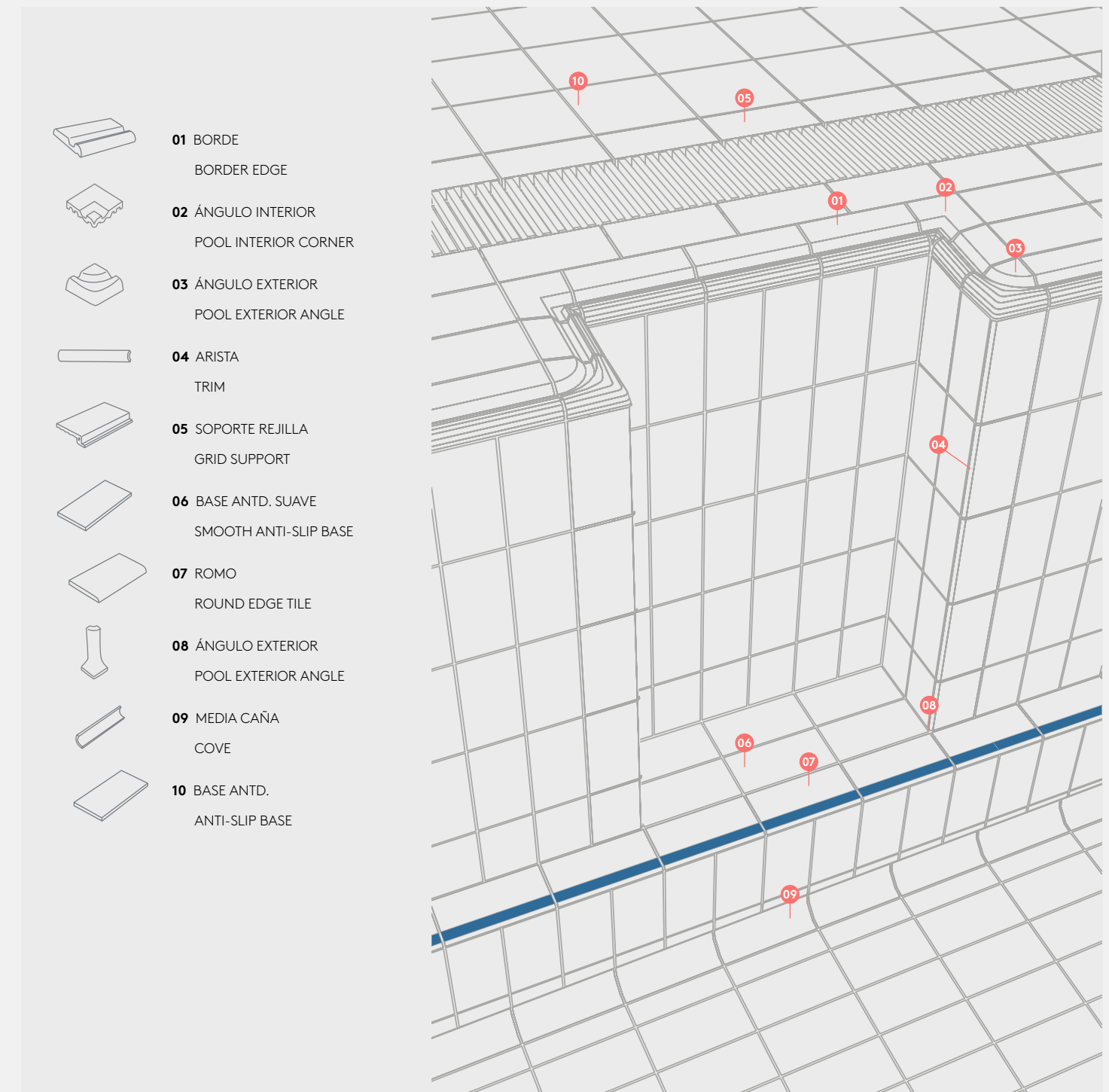



## SWIMMING POOLS CONSTRUCTION / CONSTRUCCIÓN DE PISCINAS Y ESPACIOS HÍDRICOS

Pool coverings, sport facilities and all other ludic and wellness wet areas are exposed to several different demands due to their function, the use conditions and also the setting place.

Basic requirements for a swimming pool coating are: ergonomics, resistance, waterproofing and security.

Extruded klinker ceramic is extremely resistant and offers an overall solution to all requirements needed in such installations. Shape, color and texture variety and special pieces wide range that gives functional solutions to technical design demand in order to obtain long-lasting coating with high quality finished.

Ergonomic shapes, non-pore surfaces, non slip finishes where it is necessary, bright glazings with chemical resistance to deal with water conditioning products, the disinfection and cleaning process.

Easy maintenance is equal to hygienic and healthy spaces.

Using extruded klinker ceramics is a secure and profitable investment.

Los recubrimientos de las piscinas, instalaciones deportivas y la totalidad de los espacios hídricos de uso lúdico y terapéutico, están expuestas a altas y variadas solicitudes debido a su función y también del entorno donde se ubican.

Las demandas básicas exigibles a estos recubrimientos son: ergonomía, resistencia, impermeabilidad y seguridad.

El gres extrusionado es extremadamente resistente y ofrece soluciones a todos los requisitos que se plantean en instalaciones de este tipo. Variedad de formas, colores, texturas y una amplia gama de piezas especiales que dan respuesta funcional a las demandas de diseño de los técnicos proyectistas, para obtener recubrimientos duraderos, estéticos y con alta calidad de acabados.

Formas ergonómicas, superficies sin poros, antideslizantes donde sea necesario, esmaltados luminosos y químicamente resistentes para soportar los productos de acondicionamiento del agua y los procesos de limpieza y desinfección.

Mantenimiento fácil equivale a instalación higiénica y saludable.

Utilizar gres extrusionado es una inversión segura y rentable.

## BAREFOOT WALKING AREAS FLOORING / PAVIMENTACIÓN DE PLAYAS Y ESPACIOS ANEXOS

Barefoot walking areas like those surrounding swimming pools, solariums, changing rooms and others undergo several situations: wet conditions, water from pools, dirt and dust in outdoor areas. These actions and others (impacts, abrasion, frost action) are decisive to tiles choosing criteria.

The selected tile must be no slip, with mechanical, chemical and frost resistance, very low surface porosity, and easy to clean.

APE recommends anti-slip C Class (DIN 51097) for usually wet floors in swimming pools, sport facilities and similar spaces.

Zonas interiores húmedas, vestuarios, baños, aseos y duchas.	
Superficies con pendiente menor que el 6%	Clase 2
Superficies con pendiente igual o mayor que el 6% y escaleras	Clase 3

Zonas exteriores. Piscinas (1).	
(1) Zonas previstas para usuarios descalzos y fondos de vasos de profundidad que no exceda a 1,5 m	Clase 3

Las playas y espacios anexos a una piscina, como vestuarios, servicios, solarios y otros son transitados con pie descalzo y frecuentemente con agua, humedad, ensuciamiento por uso, polvo y contaminación en caso de playas exteriores. Estas solicitudes junto a otras (golpes, abrasiones, acción de heladas) son determinantes a la hora de seleccionar una baldosa para pavimentar estos espacios.

La baldosa elegida debe ser antideslizante, con resistencia mecánica, química y a la helada, con mínima porosidad superficial y fácilmente limpiable.

La aprobación en España del Código Técnico de la Edificación (C.T.E.) supone un endurecimiento de los requisitos de antideslizamiento en las piscinas en general e instalaciones deportivas de uso público a fin de garantizar la seguridad del usuario frente al riesgo de caídas. El Documento Básico SU1 (Seguridad de Utilización) establece la obligatoriedad de pavimentos con Resistencia al Deslizamiento (Rd) en función de su localización y su Clase exigible, concretamente es: \*

APE recomienda en playas, vestuarios, servicios, locales técnicos, coronación de piscinas y otras superficies antideslizantes, utilizar baldosas y piezas especiales con textura superficial calificadas como Clase 3 (C.T.E. ensayo péndulo UNE-ENV 12633) en proyectos ejecutados dentro del territorio español. Para proyectos ejecutados en otros países recomendamos utilizar baldosas y piezas especiales calificadas como Clase C (ensayo pie descalzo, plano inclinado DIN 51097).

## INSTALLATION RECOMMENDATIONS / RECOMENDACIONES DE COLOCACIÓN

Must be considerate substrate type and conditions of use. Surface to be covered shall be cleaned to remove bitumen, soil, dust, curing compounds, form, oil, sealants or grease. In spas, therapy pools, thermal baths, leisure centers and talasotherapy (sea water pools), high resistance grouts (chemical and abrasion) is very recommended.

### BEFORE INSTALLATION. PREVIOUS TASKS

- Check tile system, different special pieces, colors and textures, and submit to Management.
- Check the substrate condition, geometry, surface quality, cracks and moisture.
- Leveling and waterproofing the substrate. Pass waterproofing test before tile installation.
- Check sizes pool, and levels (overflow and pool edge levels).
- Movement joints placement, according to Management.
- Stock-pit organization: place the tiles at different workplaces.
- Detailed layout plan: checking sizes, modularity and singular points.
- Make an installation planning, is very recommended.

### TILES INSTALLATION

- Mark the reference lines, making a control grid.
- Mark the central axe and its perpendicular lines every 2 m. making a grid pattern.
- Use mark lanes as guidelines, in the short walls and bottom of the pool.
- Place a row of tiles along both lanes. Distribute tiles between lanes, align them following the grid.
- Put the cut pieces in the bottom of the pool.
- The joint between pieces will be 5 mm. to respect modularity and the correspondence of joints between different sizes and/or specials pieces.

### THIN BED INSTALLATION

Over leveling substrate, adhesives are applied with a notched trowel. Mortar thickness is between 5 mm-10 mm. The substrate should be clean, sound, dry, plumb and true (3mm/3m). Use leveling coat mortar if need be. Over concrete walls all cracks must be repaired prior the tiling. Pool edge and back high profiled pieces, should be back-buttered to help achieve maximum coverage.

### RECOMMENDED PRODUCTS LEVELING COAT MORTAR:

Latex admix gives the mortar flexibility and bonding strength.

WATERPROOFING:

Direct bond rubber reinforced membranes.

Direct bond reinforced waterproof mortars.

SETTING:

Adhesive C2 type (EN 12004) better C2 TE type.

Use square notch trowel.

GROUTING:

CG2 type (EN 13888).

RG for stain, abrasion and high chemical resistance.

Use hard rubber trowel.

Fill the expansion joints with a flexible sealants: silicone or polyurethane.

Hay que considerar el tipo de soporte y las condiciones de uso de la instalación. La superficie a revestir debe estar limpia de asfaltos, aceites, grasas, polvo, aditivos del hormigón. En balnearios, piscinas terapéuticas, termas, hidromasajes - spas, y talasoterapia (piscinas con agua de mar) se recomienda utilizar juntas de alta resistencia química y a la abrasión.

### TAREAS PREVIAS A LA COLOCACIÓN

- Comprobar y clasificar el material suministrado a obra, diferentes baldosas y piezas especiales, colores y texturas, sometiendo el sistema de recubrimiento a la Dirección Facultativa.
- Comprobar las condiciones del soporte, geometría, aplomado de aristas y rincones, calidad superficial, retracción y humedad residual.
- Nivelar el soporte si es necesario. Impermeabilizar y verificar con Prueba de Estanqueidad.
- Comprobar dimensiones del vaso y los niveles de desborde y coronación.
- Situar las juntas de movimiento y partición de acuerdo con la D.F.
- Organización de acopios a pie de tajo.
- Replanteo detallado: medidas, modularidad y piezas en puntos singulares.
- Planificación de ejecución.

### INSTALACIÓN DE LA CERÁMICA

- Marcar líneas de referencia cada 2 m. formando una retícula de control.
- Marcar el eje de simetría y marcar las líneas de calles en las paredes cortas.
- Utilizar la marcación de calles como referencia, colocando baldosas enteras entre ellas, siguiendo la retícula.
- En caso necesario situar las piezas cortadas en el fondo del vaso.
- La junta entre las piezas será de 5 mm. para respetar la modularidad de las series y la correspondencia de juntas entre los diferentes formatos y/o piezas especiales.

### COLOCACIÓN POR EL SISTEMA DE CAPA DELGADA

- Sobre soportes regulares y nivelados, usando adhesivos mediante llana dentada.
- El espesor de mortero adhesivo es 5-10 mm.
- El soporte debe ser sano, limpio, seco, plano (3 mm de desnivel, como máximo, en 3 m.) y aplomado.
- Usar un mortero de nivelación si es necesario.
- Sobre soportes de hormigón hay reparar las grietas antes de la colocación.
- La piezas de coronación y las de cola de milano acentuadas (Groove, apoyo rejilla, ranuradas, etc) se colocarán con doble encolado para asegurar un total macizado.

### PRODUCTOS RECOMENDADOS PARA NIVELAR Y REGULARIZAR LAS SUPERFICIES:

Usar morteros con Aditivo Látex

PARA IMPERMEABILIZAR:

Membranas bituminosas reforzadas con fibras que se aplican directamente al soporte.

Morteros impermeabilizantes reforzados con fibras que se aplican directamente al soporte.

PARA INSTALAR LAS BALDOSAS:

Adhesivo Tipo C2 (según norma EN 12004) preferentemente C2TE.

Usar llana dentada.

PARA REJUNTAR:

Mortero de Juntas Tipo CG2 (según EN 13888).

Tipo RG para resistencia a las Manchas y alta Resistencia Química.

Usar llana de goma.

LAS JUNTAS DE EXPANSIÓN deben rellenarse con Selladores Flexibles de Silicona o Poliuretánicos.



### EXTRUSION VALUES / EL VALOR DE LA EXTRUSIÓN

The raw materials selected and the careful production process with the most advanced technologies and our human team work, ensure that final product have a exceptional technical characteristics.

With this process three-dimensional geometries can be obtained in the pieces, impossible to obtain with the traditional pressing process.

Las materias primas seleccionadas y el cuidado proceso de producción con las tecnologías más avanzadas y la labor de nuestro equipo humano, hacen que el producto obtenido posea unas características técnicas excepcionales.

Con este proceso se pueden obtener geometrías tridimensionales en las piezas, imposibles de conseguir con el proceso de prensado tradicional.

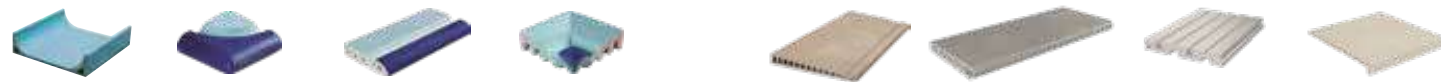

### EXTRUSION PROCESS / PROCESO DE EXTRUSIÓN

Extrusion process is a forming technique for the manufacture of ceramic products. Basically this process consists in forcing the passage, through the application of a pressure, of the paste with a plastic consistency through a matrix. The manufacture of tiles by the extrusion process entails four main phases: kneaded, shaping, drying and firing.

The kneading consists in the mixing with water of the raw materials previously prepared and ground. This provides an easily extrudable paste.

- In the shaping stage, the plastic mass using vacuum pressure is kneaded and pushed through the nozzle to make tiles. This process is widely used to make special tiles pieces like steps or swimming pool border tiles, ... etc.

- Once the tiles have been shaped, hot air is used to remove the moisture content.

- Afterwards they are fired to high temperatures, to obtain a perfect vitrification.

With this process, the tiles can be recycled completely and up to 45% recycled materials are accepted in their standard process.

La extrusión es una técnica de conformado para la fabricación de productos cerámicos. Básicamente el proceso de extrusión consiste en forzar el paso, mediante la aplicación de presión, de la pasta con consistencia plástica a través de una matriz. La fabricación de baldosas mediante el proceso de extrusión consta de cuatro fases principales: amasado, conformado, secado y cocción.

- El amasado consiste en el mezclado con agua de las materias primas previamente preparadas y molidas. Con esto se consigue una pasta fácilmente moldeable por extrusión.

- En el conformado se realiza introduciendo la masa plástica en la extrusora, y con presión de vacío es amasada y empujada a través de la boquilla para obtener las piezas finales. Con este proceso se pueden obtener piezas especiales como peldaños o bordes piscinas, etc...

- Después las piezas ya moldeadas son sometidas a aire caliente para eliminar el contenido de humedad.

- Posteriormente son cocidas a altas temperaturas, obteniendo una perfecta vitrificación de las mismas.

Con este proceso los materiales pueden ser reciclados en su totalidad y admiten hasta un 45% de materiales reciclados en su proceso estándar.

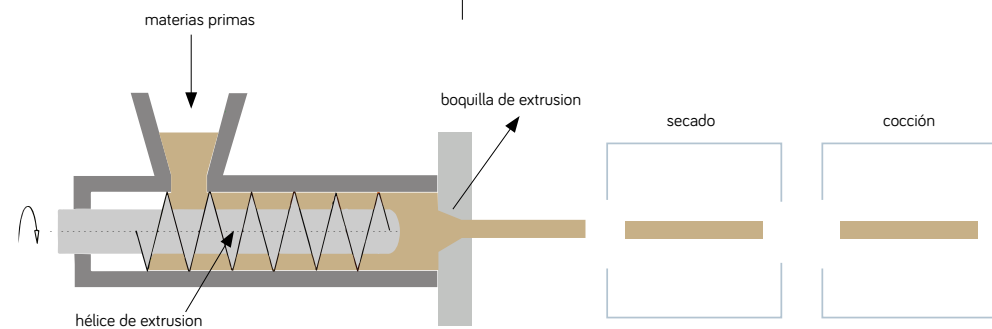

PROCESO DE EXTRUSIÓN - EXTRUSION PROCESS

### TECHNICAL DATA / CARACTERÍSTICAS TÉCNICAS

Extruded klinker KLINKER / GRES EXTRUIDO

White body extruded klinker stoneware with a low water absorption, according to EN 14411, group Alb, glazed.

Gres extruido de pasta blanca de baja absorción de agua, según UNE-EN 14411, grupo Alb esmaltado.

NORMA/TEST	DESCRIPCIÓN / DESCRIPTION	REQUISITOS / STANDARDS	PISCINAS / SERIES
ISO 10545-2	Dimensiones / Sizes Longitud y anchura / Length and width Espesor / Thickness Rectitud de los lados / Straightness of sides Ortogonalidad / Rectangularity Planaridad / Surface Flatness	± 1,5% ± 10% ± 0,6% ± 1,0 % ± 1,5 %	Cumple ampliamente la norma / Amply meets the standard
ISO 10545-3	Absorción de agua / Water absorption	≤ 3 %	≤ 1,5 %
ISO 10545-4	Fuerza de rotura / Breaking strength	≥ 1.100 N	≥ 1.300 N
ISO 10545-4	Resistencia a la flexión / Modulus of rupture	≥ 23 N/mm2	≥ 40 N/mm2
ISO 10545-9	Resistencia al choque térmico / Resistance to thermal shock	exigida / required	garantizado / guaranteed
ISO 10545-11	Resistencia al cuarteo / Crazeing resistance	exigida / required	garantizado / guaranteed
ISO 10545-12	Resistencia a la helada / Frost resistance	exigida / required	garantizado / guaranteed
ISO 10545-13	Resistencia a los agentes químicos / Chemical resistance	exigida / required	A/LA/HA
ISO 10545-14	Resistencia a las manchas / Stain resistance	exigida / required	clase 5 / class 5
UNE-ENV 12633:2003	Resistencia al deslizamiento (péndulo) / Slip Resistance (pendulum)	exigida (CTE) / required (CTE)	CLASE 3 / CLASS 3
DIN 51097	Ángulo Crítico Deslizamiento (pie descalzo) / Anti-slip resistance (barefoot)	-	GRUPO C / C GROUP
DIN 51130	Ángulo Crítico Deslizamiento (rampa) / Anti-slip resistance (ramp)	-	R10-R12



## TECHNICAL DATA / CARACTERÍSTICAS TÉCNICAS

### PORCELAIN TILE / PORCELÁNICO

	Testing method/ Método de prueba	Measurement unit/ Unidad de medida	Values/ Valores Típicos Medios	Established limits/ Valores límite previstos	Reference standard/ Norma de referencia
Water absorption in % Absorción de agua en %	ISO 10545-3	%	≤ 0,5	≤ 0,5 Maximum single value 0,6% Valor único máximo 0,6%	UNI EN 14411-G
Dimensions Dimensiones	ISO 10545-2	mm %	Complies with the standards. Conforme con las normas.	N ≥ 15	UNI EN 14411-G
Length and width Longitud y anchura				± 2 % max ± 5 mm	
Length and width Longitud y anchura				± 0,6 % ± 2 mm	
Length and width Longitud y anchura				± 0,6 % ± 2 mm	
Thickness Espesor				± 5 % ± 0,5 mm	
Edge straightness Rectitud de los cantos				± 0,5 % ± 1,5 mm	
Orthogonality Ortogonalidad				± 0,5 % ± 2 mm	
Flatness Planeidad				x ± 0,5 % ± 2 mm	
Appearance Aspecto				≥ 95%	
Bending strength Resistencia a la flexión	ISO 10545-4				UNI EN 14411-G
Modulus of rupture Módulo de rotura		N/mm <sup>2</sup>	≥ 28	28 Minimum single value 21 Valor único mínimo 21	UNI EN 14411-G
Breaking strenght Esfuerzo de rotura		N	≥ 1300	≥ 1300	UNI EN 14411-G

## TECHNICAL DATA / CARACTERÍSTICAS TÉCNICAS









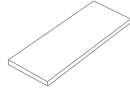
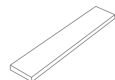

### PORCELAIN TILE / PORCELÁNICO

	Testing method/ Método de prueba	Measurement unit/ Unidad de medida	Values/ Valores Típicos Medios	Established limits/ Valores límite previstos	Reference standard/ Norma de referencia
Resistance deep abrasion Resistencia a la abrasión profunda	ISO 10545-6	mm <sup>3</sup>	120-150	≤ 175	UNI EN 14411-G
Frost resistance Resistencia a la helada	ISO 10545-12		Complies with the stan- dards Conforme con las normas	Test passed in accordan- ce with the en iso 10545-1 standard Prueba superada de con- formidad con la norma EN ISO 10545-1	UNI EN 14411-G
Thermal shock resistance Resistencia al choque térmico	ISO 10545-9		Complies with the stan- dards Conforme con las normas	Test passed in accordan- ce with the en iso 10545-1 standard Prueba superada de con- formidad con la norma EN ISO 10545-1	UNI EN 14411-G
Linear thermal expansion coefficient Coeficiente de dilatación térmica lineal	ISO 10545-8	x10 <sup>-6</sup> /°C	≤ 9	Test method available Método de control disponible	UNI EN 14411-G
Stain resistance Resistencia a las manchas	ISO 10545-14		Clase 5 Class 5 Categoría 5	Value declared Valor declarado	UNI EN 14411-G
Resistance to chemicals for household use and swimming pool salts Resistencia a los productos químicos para uso doméstico y sales para piscina	ISO 10545-13		A	B Minimum B Mínimo	UNI EN 14411-G
			LA - LB HA - HB	Value declared Valor declarado	UNI EN 14411-G
Color resistance to light exposure Resistencia de los colores a la exposi- ción de la luz	DIN 51094		Complies with the stan- dards Conforme con las normas	No sample must show noticeable color modifi- cations. Ninguna muestra ha de presentar alteraciones apreciables de color.	
Resistenza allo scivolamento Skid resistance Resistencia al deslizamiento	RAMP METHOD		R9	from R9 to R13 de R9 a R13	DIN 51130 BGR 181 1
			R10		
			R11		
			R12V4		







**PACKING LIST/LISTA DE EMBALAJE**  
EXTRUDED KLINKER/GRES EXTRUIDO

PRIVATE POOL/PISCINA PRIVADA

	SIZE/FORMATO	Piezas/caja Pieces/box	Kg/caja Kg/box	Cajas/pallet Boxes/pallet	Kg/pallet Kg/pallet
	Base 33x33 cm	9 9 pcs/m2	22,18	56	1242
	Base 33x66,5 cm	5 4,5 pcs/m2	25,38	40	1015
	Base 16,25x66,5 cm	10 9 pcs/m2	25,30	40	1012
	Base 32,5x32,5 cm	7 9 pcs/m2	24,10	63	1518
	Base 32,5x32,5x1,2 cm	9 9 pcs/m2	21,33	63	1344
	Borde desbordante 28x66,5 cm	2	13,60	72	980
	Rejilla 24,5x24,5 cm	6 4 pcs/ml	15,78	57	900
	Media caña 33x4 cm - r 3 cm	52 3 pcs/ml	13	64	832
	Arista 33x3x cm - r3 cm	70 3 pcs/ml	13	64	832
	Uña 4x4 cm	4	0,4	72	30
	Uña arista 3x3 cm	4	0,4	72	30
	Peldaño recto 33x60x3 cm	2	11,70	20	234
	Peldaño recto 33x120x3 cm	2	23,64	11	260
	Peldaño recto 33x33x3 cm	4	12,25	56	686,04

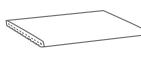
**PACKING LIST/LISTA DE EMBALAJE**  
EXTRUDED KLINKER/GRES EXTRUIDO











PRIVATE POOL/PISCINA PRIVADA

	SIZE/FORMATO	Piezas/caja Pieces/box	Kg/caja Kg/box	Cajas/pallet Boxes/pallet	Kg/pallet Kg/pallet
	Borde Skimmer 45x75 cm	2 1,33 pcs/ml	31,40	30	942
	Ángulo Interior Piscina 33x33 cm	1	4,80	92	441
	Ángulo Exterior Piscina 28x28 cm	1	4,00	92	368
	Borde Piscina 28x66,5 cm	1 1,5 pcs/ml	10,75	72	774

















**PACKING LIST / LISTA DE EMBALAJE**  
EXTRUDED KLINKER / GRES EXTRUIDO

PUBLIC POOL / PISCINA PÚBLICA

	Size / Formato	Pzs/Caja Pieces/Box	Kg/Caja Kg/Box	Cajas/Pallet Boxes/Pallet	Kg/Pallet Kg/Pallet
	Borde Dots 12x24,5x2,6 cm	12 4 pcs/ml	13,80	63	870
	Borde Esquina Dots 17x17 cm	4	6,00	-	-
	Ángulo Interior Dots 12x12 cm	4	3,70	-	-
	Ángulo Exterior Dots 12x12 cm	4	2,80	-	-
	Soporte Rejilla Dots 13,5x24,5x3,5 cm	8 4 pcs/ml	9,5	96	912
	Canaleta 15x24,5x3,5 cm	8 4 pcs/ml	11,12	69	768
	Canaleta Sumidero 15x24,5x3,5 cm	8 4 pcs/ml	11,00	69	768
	Base Dots 12x24,5 cm	35 32 pcs/m <sup>2</sup>	19,25	77	1.482
	Base Dots 24,5x24,5 cm	16 16 pcs/m <sup>2</sup>	19,79	69	1.365
	Borde Grooved 12x24,5x2,6 cm	12 4 pcs/ml	13,80	63	870
	Borde Esquina Grooved 17x17 cm	4	6,00	-	-
	Ángulo Interior Grooved 12x12 cm	4	3,70	-	-
	Ángulo Exterior Grooved 12x12 cm	4	2,80	-	-
	Soporte Rejilla Ranurada 13,5x24,5x3,5 cm	8 4 pcs/ml	9,5	96	912
	Canaleta 24,5x24,5x6,5 cm	4 4 pcs/ml	10,28	36	370
	Canaleta Sumidero 24,5x24,5x6,5 cm Ø 50 - 65 mm	4 4 pcs/ml	10,28	36	370

**PACKING LIST / LISTA DE EMBALAJE**  
EXTRUDED KLINKER / GRES EXTRUIDO









PUBLIC POOL / PISCINA PÚBLICA

	Size / Formato	Pzs/Caja Pieces/Box	Kg/Caja Kg/Box	Cajas/Pallet Boxes/Pallet	Kg/Pallet Kg/Pallet
	Base Ranurada 12x24,5 cm	35 32 pcs/m <sup>2</sup>	19,25	77	1.482
	Base Antideslizante suave 12x24,5 cm	35 32 pcs/m <sup>2</sup>	19,25	77	1.482
	Romo 17,0x17,05 cm	35 4 pcs/ml	19,25	77	1.482
	Esquina Interior 12x12 cm	4	3,20	-	-
	Esquina Exterior Romo 12x12 cm	4	3,92	-	-
	Esquina Ext. Romo Arista 12x12 cm	4	3,92	-	-
	Angular 12x24,5x3 cm	16 4 pcs/ml	13,92	52	677
	Esquina Ext. Angular Romo 12x12x3 cm	4	1,98	-	-
	Esquina Ext. Angular Arista 12x12x3 cm	4	2,00	-	-
	Base 12x24,5 cm	35 32 pcs/m <sup>2</sup>	19,25	77	1.482
	Zócalo sanitario con escocia esmaltado 12x24,5x3,5 cm	16 4 pcs/ml	12,10	57	684
	Ángulo Interior 12x4,75 cm r=3 cm	15	0,55	-	-
	Ángulo Exterior 12x4,75x4,75 cm r= 3 cm	10	0,82	-	-
	Media caña 24,5x4 cm r= 3 cm	50	7,60	114	870



**PACKING LIST / LISTA DE EMBALAJE**  
EXTRUDED KLINKER / GRES EXTRUIDO

PUBLIC POOL / PISCINA PÚBLICA

	Size / Formato	Pzs/Caja Pieces/Box	Kg/Caja Kg/Box	Cajas/Pallet Boxes/Pallet	Kg/Pallet Kg/Pallet
	Arista 24,5x3 cm	64 4 pcs/ml	8,45	114	970
	Uña 4x4 cm r= 3 cm	4	0,40	72	30
	Uña arista 3x3 cm	4	0,40	72	30
	Media caña 24,5x8 cm	20 4 pcs/ml	7,60	128	958
	Arista 24,5x8 cm	22 4 pcs/ml	7,00	114	800
	Ángulo exterior Arista 12x8x8 cm	4	1,30	-	-
	Ángulo interior Arista 12x8x8 cm	4	1,30	-	-
	Uña 8x8 cm	4	0,60	-	-
	Uña arista 8x8 cm	4	0,60	-	-

**PACKING LIST / LISTA DE EMBALAJE**  
PORCELÁNICO / PORCELAIN TILES

	Size / Formato	Pzs/Caja Tiles/Box	M <sup>2</sup> /Caja Sqm/Box	Kg/Caja Kg/Box	Cajas/Pallet Boxes/Pallet	M <sup>2</sup> /Pallet Sqm/Pallet	Kg/Pallet Kg/Pallet
4.Stones	60X120	2	1,44	34,54	36	51,84	1.244
	60X60	3	1,08	25,22	40	43,20	1.009
	40X120	1	0,48	22,38	48	23,04	1.074
	30X120	4	1,44	34,44	36	51,84	1.240
	30X60	6	1,08	27,58	40	43,20	1.103
	20X120	4	0,96	23,08	40	38,40	923
	90X90	2	1,62	37,34	24	38,88	896
Alabama	20X120	6	1,44	32,05	44	63,36	1.430
Koen	30X120	3	1,06	24,42	40	42,40	977
	20X120	4	0,96	22,88	48	46,08	1.098
Oregón	20X120	4	0,96	22,87	48	46,08	1.098
Oxford	33X66,5	5	1,10	25,84	40	44,00	1.033
Pierre de Bali	15X15	22	0,49	9,94	120	59,40	1.213
	30X60	6	1,08	22,50	48	51,84	1.100
Vita	120X120	1	1,44	37,64	36	51,84	1.355
	60X120	2	1,44	37,72	30	43,20	1.130
Wabi Sabi	120X120	1	1,44	37,64	36	51,84	1.355
	60X120	2	1,44	37,72	30	43,20	1.130
	60X60	4	1,44	31,60	30	43,20	970
	30X60	6	1,08	24,04	48	51,84	1.154
	75X75	2	1,13	25,33	48	54,24	1.216
	20X120	4	0,96	22,52	48	46,08	1.081
Work	120X120	1	1,44	35,82	36	51,84	1.289
	60X120	2	1,44	34,54	36	51,84	1.243
	60X60	3	1,08	25,22	40	43,20	1.008
	30X60	6	1,08	22,16	48	51,84	1.063
	30X120	3	1,08	25,94	48	51,84	1.245
	20X120	3	0,72	17,00	60	43,20	1.036
	21X18,2	16	0,45	9,80	100	45,85	980



## TECHNICAL SERVICE / SERVICIO TÉCNICO

Technical support & Information services for APE Distributors, Architects, Engineers and contractors, to provide technical assistance:

- Products specifications and choice criteria
- AutoCAD 3D design service
- Architectural details and design proposals
- Determination of quantities
- Technical information, product tests and certificates
- Job site support and post-installation service
- Technical reports and installation suggestions

El Dpto. de Asistencia Técnica de APE, está a disposición de Técnicos Prescriptores, Dirección Facultativa y Distribuidores, para ofrecerles soporte técnico sobre:

- Especificación de productos y criterio de selección
- Servicio de diseño AutoCAD 3D
- Detalles constructivos y propuestas de diseño
- Despieces y Mediciones
- Documentación técnica, fichas, ensayos y certificados
- Asistencia técnica en obra y servicio post-venta
- Informes y recomendaciones de instalación

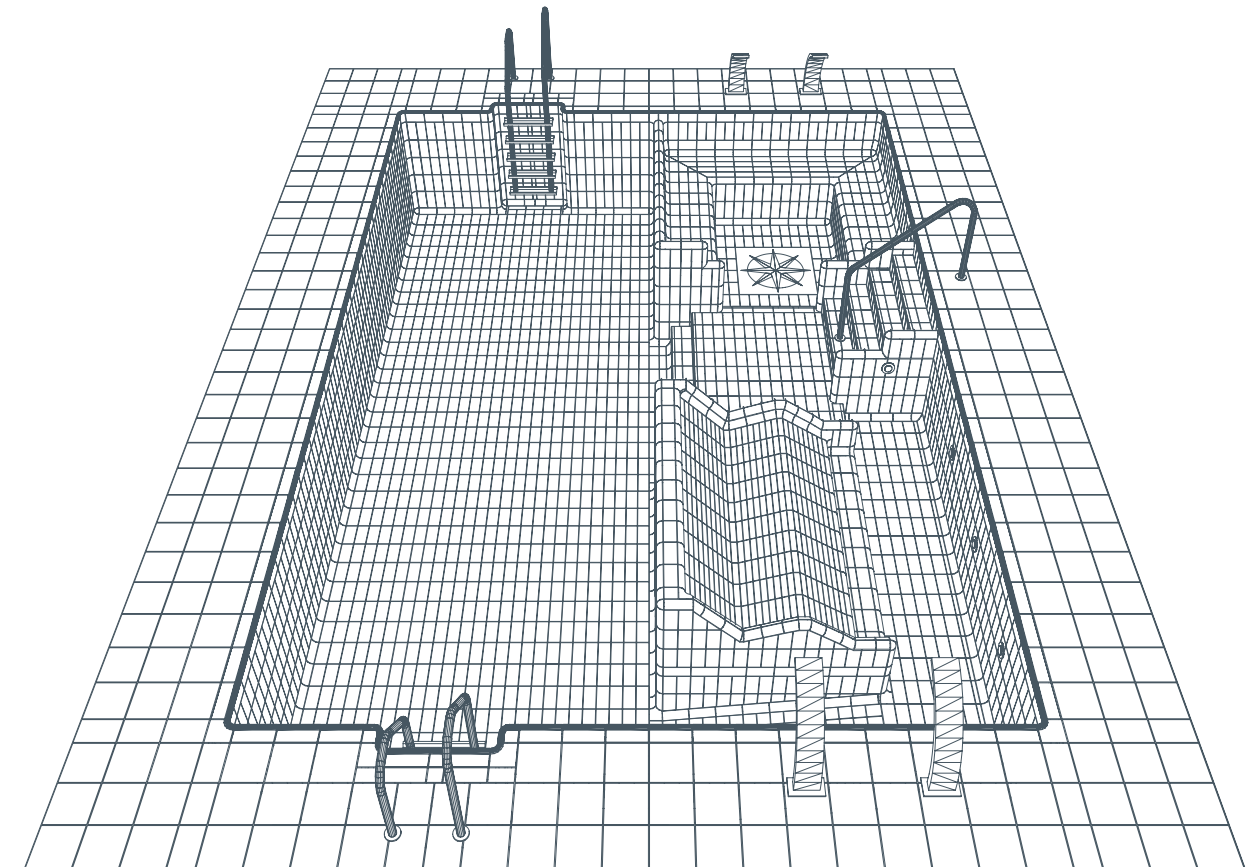





CLEANING AND MAINTENANCE:

CLEANING AFTER LAYING:
WE SUGGEST A GOOD INITIAL CLEANING AFTER THE LAYING ON THE FLOOR OR WALL, THIS IS VERY IM-PORTANT FOR REMOVING RESIDUAL GROUTING AND THE NORMAL DIRT COMING FROM THE BUILDING WORKS.

WE SUGGEST THE USE OF OUR PRODUCT FILA DETERDEK, THAT IS A LIGHTLY ACID PRODUCT THAT DOESN'T EMIT FUMES THAT ARE HARMFUL FOR THE USER AND THAT CAN ATTACKS JOINTS.

REGULAR MAINTENANCE:
FOR A GOOD CLEANING OF THE FLOOR WE SUGGEST THE USE OF OUR PRODUCT FILA CLEANER IT'S A NATURAL DETERGENT WITH A HIGH CLEANING POWER.

TYPE OF DIRTY	DAS RICHTIGE PRODUCT
ZEMENT, KALKSTEIN, METAL TRACER, RUST	DETERDEK
RESIDUALS, STAINS AND HALOS OF EPOXI JOINTS	FILA CR10
GREASY, DRINKS, FOOD, TIRE MARKS, COLOURS, MARKER, ETC.	FILA PS/87
GRAFTIS	FILA NOPAINT STAR
WAX CANDEL, BITUMEN, ADHESIVE TAPE RESIDUES.	FILASOLV

REINIGUNG UND PFLEGE:

ERSTREINIGUNG:
WIR EMPFEHLEN EINE ERSTREINIGUNG NACH DER FLIESENVERLEGUNG, DIE SEHR WICHTIG UM ZEMENTRÜCKSTÄNDE, KLEBER UND SCHMUTZ VERSCHIEDER ART ZU ENTFERNEN IST.
WIR EMPFEHLEN UNSERES PRODUKT FILA DETERDEK, EIN LEICHT SÄURIGEHALTES PRODUKT, DAS KEINE SCHÄDLICHE DÄMPFE FÜR DEN ANWENDER UND DIE UMWELT GIBT UND WIRKUNGSVOLL AUF MÖRTEL IST.

UNTERHALTSPFLEGE:
FÜR EINE NORMALE FLÄCHENREINIGUNG, EMPFEHLEN WIR UNSERES PRODUKT FILA CLEANER, DAS UNIVERSALREINIGER.

ART VON SCHMUTZ	DAS RICHTIGE PRODUKT
ZEMENT, KALKSTEIN, METALLSPÜREN, ROST	DETERDEK
RÜCKSTANDE, FLECKEN UND RÄNDERN VON EPOXIDMÖRTEL	FILA CR10
FETT, GETRÄNKE, ESSEN, REIFENSPIUREN, FARBEN, ETC.	FILA PS/87
GRAFFITI	FILA NOPAINT STAR
WACHSE, BITUMEN, KLEBER.	FILASOLV

ЧИСТКА И ОБСЛУЖИВАНИЕ;
ЧИСТКА ПОСЛЕ РЕМОНТНЫХ РАБОТ;
МЫ ПРЕДЛАГАЕМ ХОРОШУЮ НАЧАЛЬНУЮ ЧИСТКУ ПОСЛЕ РЕМОНТНЫХ РАБОТ НА ПОЛУ ИЛИ СТЕНАХ, ТАК КАК ЭТО НЕОБХОДИМО ДЛЯ УДАЛЕНИЯ ОСТАТКОВ ГРУНТА И ОБЫЧНОЙ ГРЯЗИ, ВОЗНИКАЮЩЕЙ В РЕЗУЛЬТАТЕ СТРОИТЕЛЬНЫХ РАБОТ.
МЫ ПРЕДЛАГАЕМ ВОСПОЛЬЗОВАТЬСЯ НАШИМ ПРОДУКТОМ FILLA DE-TERDEK, КОТОРЫЙ НЕ СОДЕРЖИТ БОЛЬШОГО КОЛИЧЕСТВА КИСЛОТЫ, ОПАСНОЙ ДЛЯ ЗДОРОВЬЯ.
РЕГУЛЯРНОЕ ОБСЛУЖИВАНИЕ;
ДЛЯ ХОРОШЕЙ ЧИСТКИ ПОЛА МЫ ПРЕДЛАГАЕМ НАШ ПРОДУКТ FILLA CLEANER- ЭТО НАТУРАЛЬНОЕ МОЮЩЕЕ СРЕДСТВО, С ВЫСОКОЙ МОЮЩЕЙ СПОСОБНОСТЬЮ.
ДЛЯ ЭКСТРЕННОЙ ЧИСТКИ:

ВИД ЗАГРЯЗНЕНИЯ	ПРОДУКТ ИСПОЛЬЗОВАНИЯ
ЦЕМЕНТ, НАЛЕТ, РЖАВЧИНА	DETERDEK
ОСТАТКИ И ПЯТНА ЭПОКСИДНОЙ СМОЛЫ	FILLA CR10
ЖИР, ПЯТНА ОТ НАПИТКОВ И ЕДЫ, КРАСКА, СЛЕДЫ ОТ МАРКЕРОВ	FILA PS/87
ГРАФИТИ	FILLA NOPAINT STAR
ВОСК, БИТУМ, ОСТАТКИ ИЗОЛЯЦИОННОЙ ЛЕНТЫ	FILASOLV

INDICATIONS DE NETTOYAGE ET DE ENTRETIEN

NETTOYAGE DE FIN DE CHANTIER
APRÈS LA POSE EST IMPORTANT NETTOYER CORRECTEMENT POUR ELIMINER LES RÉSIDUES DES JOINTS ET EN GENERAL LA SALETÉ DE APRÈS CHANTIER
POUR BIEN EFFECTUER CETTE OPERATION NOUS CONSEILLONS L'UTILISATION D' UN DETERGENT LEGEREMENT ACIDE QUI N'EXHALE PAS DES FUMÉES TOXIQUES ET QUI RESPECTE LES JOINTS, LE MATÉRIEL COMME LE DETERDEK.

ENTRETIEN ORDINAIRE:
POUR UN ENTRETIEN DU SOL NOUS VOUS CONSEILLONS L'UTILISATION DE UN DETERGENT NEUTRE AVEC UN POUVOIR DE NETTOYAGE ÉLEVÉ COMME LE FILACLEANER

TYPE DE SALETÉ	PRODUIT À UTILISER
CIMENT, CALCAIRE DE L'EAU, OXIDES, SALETÉ METALLIQUE	DETERDEK
RÉSIDUS, TACHES ET AURÉOLES DE MORTIER DE JOINTOIEMENT ÉPOXY	FILA CR10
GRAISSE, BOISSONS, NOURRITURE, CHEWINGUM, STYLO,TEINTURES	FILA PS/87
VERNIS POUR LE GRAFFITTIS	FILA NOPAINT STAR
CIRES DE CHANDELLE, RÉSINE DES ARBRES, RÉSIDUES DE SCOTCH	FILASOLV



<b>RECOMMENDED PRODUCT / PRODUCTO RECOMENDADO / PRODUIT RECOMMANDÉ</b>	<b>TYPE OF DIRT / TIPO DE SUCIEDAD / TYPE DE SALETÉ</b>		
CEMENT REMOVER	CEMENT-BASED GROUT	RESIDUOS JUNTA CEMENTOSA	MORTIER CIMENT
	CONCRETE, PLASTER, WALL PAINT	CEMENTO, YESO, PINTURA PARA PARED	CIMENT, PLÂTRE, PEINTURE MURALE
	COAL, RUST, SALT EFFLORESCENCES	CARBÓN, ÓXIDO, EFLORESCENCIAS SALINAS	CHARBON, ROUILLE, SELS EFFLORESCENCES
EPOXY CLEANER	EPOXY GROUT	JUNTA EPOXÍDICA	MORTIER ÉPOXY
	BLACK SUCTION-CUP MARKS	MARCAS NEGRAS DE VENTOSA EN SUPERFICIES MATE	MARQUES NOIRES DE VENTOUSE
FLOOR CLEANER	DAILY ORDINARY CLEANING	LIMPIEZA DIARIA ORDINARIA	NETTOYAGE QUOTIDIEN NORMAL
TILE CLEANER	SUPERFICIAL PATINA, HEAVY DUTY CLEANING	PÁTINA SUPERFICIAL, LIMPIEZA PROFUNDA	PATINE SUPERFICIELLE, NETTOYAGE À FOND
	METAL MARKS, SIGNS AND RESIDUES	MARCAS Y RESIDUOS METÁLICOS	MARQUES DE MÉTAL, AURÉOLES ET RÉSIDUS
	STUBBORN DIRT, LIMESCALE BUILD-UPS, FOOTPRINT	SUCIEDAD OBSTINADA, ACUMULACIÓN DE CAL, HUELLAS	SALETÉ OBSTINÉE, ACCUMULATION DE CALCAIRE, EMPREINTES
COLOURED STAIN REMOVER	COFFE, WINE, DRINKS	CAFÉ, VINO, BEBIDAS	CAFÉ, VIN, BOISSONS, GLACES
	MARKER PEN, PERMANENT INK, HAIR DYE	ROTULADOR, TINTA PERMANENTE, TINTE PARA EL CABELLO	MARQUEURS, ENCRE PERMANENT, TEINTURE DES CHEVEUX
DEEP DEGREASER	OIL, GREASE, BITUMINOUS RESIDUES	ACEITES, GRASAS, RESIDUOS BITUMINOSOS	HUILE, GRAS, RÉSIDUS BITUMINEUX
	WAX, RUBBER MARKS, TYRE MARKS	CERAS, MARCAS DE CAUCHO, MARCAS DE NEUMÁTICO	CIRE, MARQUES DE CAOUTCHOUC, MARQUES DE PNEUS
	SILICONE	SILICONA	SILICONE
	GREASY STAINS AND RESIDUES	RESIDUOS Y MANCHAS DE GRASA	TACHES DE GRAS ALIMENTAIRE ET RÉSIDUS
ALKALINE CLEANER	WATER-REPELLENT SUCTION-CUP MARKS	MARCAS DE VENTOSAS	MARQUES HYDROFUGES DE VENTOUSE
HONING CREAM	BACK-MARKS FROM MATT SURFACES	MARCA DE COSTILLA EN SUPERFICIES NO PULIDAS	MARQUES AU VERSO DUES À SURFACE MATTE
POLISHING CREAM	BACK-MARKS FROM POLISHED SURFACE	MARCA DE COSTILLA EN SUPERFICIES PULIDAS	MARQUES AU VERSO DUES À SURFACE POLIE
SHINE REPAIR LIGHT	SCRATCHES FROM LIGHT COLOURED POLISHED SURFACE	MARCAS Y ARAÑAZOS EN SUPERFICIES PULIDAS – COLORES CLAROS	RAYURES SUR SURFACE POLIE, COULEURS CLAIRES
SHINE REPAIR DARK	SCRATCHES FROM DARK COLOURED POLISHED SURFACE	MARCAS Y ARAÑAZOS EN SUPERFICIES PULIDAS – COLORES OSCUROS	RAYURES SUR SURFACE POLIE, COULEURS FONCÉES

<b>EMPFÖHLENES PRODUKT / PRODOTTO SUGGERITO / РЕКОМЕНДУЕМЫЙ ПРОДУКТ /</b>	<b>ART VON SCHMUTZ / TIPO DI SPORCO / ВИД ЗАГРЯЗНЕНИЯ</b>		<b>حرت قملما چوتنجلما</b>	<b>خاستملا عون</b>
CEMENT REMOVER	ZEMENTMÖRTEL	STUCCO CEMENTIZIO / ЦЕМЕНТНАЯ ЗАТИРКА	تتمسلا ليزم	يتمسلا صجلا
	BETON, GIPS, WANDFARBE	CEMENTO, INTONACO, PITTURA MURALE / ЦЕМЕНТ, ШТУКАТУРКА, НАСТЕННАЯ КРАСКА	يسكويولا فظنم	جلملا تارولديو انصلا، محظلا ناردجلا ءلاطو صجلا، تئاسرخلا
	KOHLE, ROST, SALZSÄUBLÜHUNGEN	CARBONE, RUGGINE, EFFLORESCENZE SALINE / УГОЛЬ, РЖАВЧИНА, ВЫСОЛЫ	يتمسلا فظنم	يفسكويولا صجلا
EPOXY CLEANER	EPOXIDMÖRTEL	STUCCO EPOSSIDICO / ЭПОКСИДНАЯ ЗАТИРКА	ضرلا فظنم	طفشلا بواوكلا ءانوم تاملاء
	SCHWARZE SAUGNAPFSPUREN	RESIDUI DI VENTOSA NERI / ЧЕРНЫЕ СЛЕДЫ ПРИСОСОК	طلابلا فظنم	يداعلما يمويلا فيظنتللا
FLOOR CLEANER	TÄGLICHE REINIGUNG	PULIZIA QUOTIDIANA / ПОВСЕДНЕВНАЯ УБОРКА	قشاشا فيظنتللا ، يمحظسلا راجزرا	تمينمعا اياقوبو تامال ع
TILE CLEANER	ÖBERFLÄCHLICHE PATINA, TIEFENREINIGUNG	PATINA SUPERFICIALE, PULIZIA DI PROFONDITÀ / ПОВЕРХНОСТНАЯ ПАТИНА, ЧИСТКА УСТОЙЧИВОГО ЗАГРЯЗНЕНИЯ	ةغحصلا ليزم قنولملا	تمينكللا تابسرتلا مكارة ، تدينمعا خامبوللا
	METALLSPUREN, ZEICHEN UND RÜCKSTÄNDE	SEGNI E RESIDUI METALLICI / МЕТАЛЛИЧЕСКИЕ СЛЕДЫ И ОСТАТКИ	قيمعلا فظنملا	ميرك سويلاو تابورشملا رمدخل، قرومظلا رعشه تغبص ، مئالدا ربحلا ، ملقولا قمال ع
	HARTNÄCKIGER SCHMUTZ, KALKSTEIN, FUSSABDRUCK	SPORCO INTENSO, CALCFARE, IMPRONTE / УСТОЙЧИВОЕ ЗАГРЯЗНЕНИЕ, НАКИПЬ, ОТПЕЧАТКИ	قيمعلا فظنملا	روصو تاملاء ، طاطملا تاملاء ، عمشه تمينموتيد تافلخم ، موحش ، تويرز
COLOURED STAIN REMOVER	KAFFEE, WEIN, GETRÄNKE	CAFFE, VINO, BEVANDE, INCHIOSTRI / КОФЕ, ВИНО, НАПИТКИ, ЧЕРНИЛА	نويكاييس	ناهايقيو تمينملا باعظلا عقي
	MARKER, TINTE, HAARFÄRBE MITTEL	PENNARELLI INDELEBILI, TINTA PER CAPELLI / ПЕРМАНЕНТНЫЙ МАРКЕР, КРАСКА ДЛЯ ВОЛОС	نويل الكلا فظنم	ءاملا تمواقملا طفشلا
DEEP DEGREASER	ÖL, FETT, BITUMINÖSE RÜCKSTÄNDE	OLIO, GRASSO, RESIDUI BITUMINOSI / МАСЛЯНЫЕ И ЖИРОВЫЕ ЗАГРЯЗНЕНИЯ, БИТУМНЫЕ ОСТАТКИ	ريشقتلا ميرك	"تام" محظم نم ءيفلخل تامالخل
	WACHS, GUMMIRÜCKSTÄNDE, REIFENSPIUREN	CERA, SEGNI DI GOMMA, SEGNI DI PNEUMATICI / ВОСК, СЛЕДЫ ОТ РЕЗИНЫ, СЛЕДЫ ОТ ШИН	عيمتللا ميرك	لوقصملا محظسلا نم ءيفلخل تامالخل
	SILIKON	SILICONE / СИЛИКОН	عءلملا حالصلا ءيضلملا	نوللا تحفأة شوووخ
	FETTFLICKEN UND RÜCKSTÄNDE	MACCHIE E RESIDUI DI CIBO GRASSI / ЖИРНЫЕ ПИЩЕВЫЕ ПЯТНА И ОСТАТКИ	ملظملا عململا حالصلا	قماء نول نم شوووخ
ALKALINE CLEANER	WASSERABWEISENDE SAUGNAPFSPUREN	RESIDUI DI VENTOSA IDROREPELLENTI / ГИДРОФОБНЫЕ ОСТАТКИ ПРИСОСОК		
HONING CREAM	RÜCKSPUREN AUF MATTEN OBERFLÄCHEN	ENGOBBIO SU SUPERFICI OPACHE / АНГОВ НА МАТОВЫХ ПОВЕРХНОСТЯХ		
POLISHING CREAM	RÜCKSPUREN AUF POLIERTER OBERFLÄCHE	ENGOBBIO SU SUPERFICI LUCIDE / АНГОВ НА БЛЕСТЯЩИХ ПОВЕРХНОСТЯХ		
SHINE REPAIR LIGHT	KRATZER AUF EINER POLIERTEN HELLEN OBERFLÄCHE	GRAFFI SU SUPERFICI LUCIDE CHIARE / ЦАРАПИНЫ НА ПОЛИРОВАННОЙ СВЕТОЙ ПОВЕРХНОСТИ		
SHINE REPAIR DARK	KRATZER AUF EINER POLIERTEN, DUNKLEN OBERFLÄCHE	GRAFFI SU SUPERFICI LUCIDE SCURE / ЦАРАПИНЫ НА ПОЛИРОВАННОЙ ТЕМНОЙ ПОВЕРХНОСТИ		

التنظيف والصيانة:

التنظيف بعد تركيب بلاط الأرضيات

بعد تركيب بلاط الأرضيات أو الجدران يوصى بغسله لإزالة الحشو المتبقي والأوساخ الناتجة عن الأشغال. ولهذا الغاية، فمن المستحسن استخدام منتج DETERDEK ، القليل الحموضة ولا تتبعث منه أبخرة ضارة بمركب البلاط أو أية أبخرة قد تؤدي إلى تلف اللحامات.

الصيانة

لتنظيف جيد لبلاط الأرضيات، نقترح استخدام منتج FILECLEANER ، وهو عبارة منظف محايد عالي الفعالية.

غسل استثنائي

بمرانلملا چتنجلما	خاسبول عون
DETERDEK	انصلاو ريچلماو تنجسالا
FILLA CR10	يسكويوبسيالا زوجململا تالامو عقوبو كيمسرتلملا اياقوبلا
FILLA PS/87	تتاراطلالا نع ءجتانللا تامالخل او قئيلاخل داوملاو تاسورشملاو ،نوملا جلا ،مالقالاو
FILLA NOPAINT STAR	ناردجلا علع تاموسرلا
FILASOLV	قوصاللا فطرشالا اياقوب ،راقلا ،عمشللا



La reproducción de los colores es aproximada. Ape grupo se reserva el derecho de alterar o modificar los productos aquí relacionados.

*The reproduction of the colours is approximate. Ape grupo reserves the right to alter or amend the products here stated.*

Los códigos de precios y referencias deben verificarse ya que puede haber errores tipográficos.  
Es recomendable consultar la web ya que cualquier producto de ese catálogo puede sufrir cambios en códigos de venta, formatos, packing,.

*Price codes and product codes should be checked, since there may be typographical errors.  
We always recommend consulting the website as the products could undergo price code, format or packing changes.*

En la web también pueden consultar las características técnicas, consejos de colocación , elementos de merchandising o los diversos ambientes de cada una de las colecciones.

*On the website you can also find the technical specifications, installation suggestions, merchandising elements and a variety of room scene pictures for each of the collections.*