

PRODUCT CATALOGUE



COMPANY PROFILE

Kenzai Ceramics Industry Company Limited is a manufacturer and exporter of unglazed and homogeneous ceramic tiles which have been fired at 1,300 degree Celsius. Kenzai ceramic tiles have been created for natural-look in both the surface and its colors.

Kenzai Ceramics Industry Company Limited has been established since 1983 as Primarn Ceramics Co., Ltd.

In 1991, Primarn Ceramics Co., Ltd. was renamed to Kenzai Ceramics Industry Co., Ltd. With the registered capital of 10 million THB.

In 2003, Kenzai has increased the registered capital to 60 million THB.

In 2004, Kenzai Art & Design Co., Ltd. was established with the registered capital of 50 million THB. This new venture allowed Kenzai to bring in high technology machinery and know-how from Italy and Germany.

In 2005, as Kenzai Ceramics Industry Co., Ltd. increased its registered capital to 80 million THB, Kenzai Art & Design Co., Ltd. also increased its registered to 120 million THB.

In 2006, Kenzai was able to manufacture a total 4,000 square meters of ceramic tiles per day.

In 1999, Kenzai expanded and began exporting to U.S.A., Japan, Philippines, India, Saudi Arabia, U.A.E., Qatar, and Singapore.

Kenzai Ceramics Industry Co., Ltd. intends to develop high quality, natural look and durable products to serve needs of the consumers which include commercial, residential and government projects.

Kenzai ceramic tiles have passed ASTM Standard Test from U.S.A. and EN87 Standard Test from Italy.

Index

GRANITE TILE	6	1
GRANITO PORCELAN TILE	10	
GRANITO PORCELAN TILE (on net)	12	2
ROCKY	16	
HARMONY	18	
HARMONY ON NET	20	
MARINA	22	
MARINA ON NET	24	
COLORADO	26	
COLONIAL	28	
VICTORIA	30	
ICEBERG	32	
ARMSTONE	34	
TUSCANY STONE	36	
ITALIAN MODERN DESIGN	38	4
NAPOLIE STONE	40	
FUJI TILE	42	
HEXA TILE	44	
NINE IN ONE	46	
NARITA	48	5
MELBOURNE	49	
PHOENIX	50	
LUGA	51	
GRANITE G	52	
EXTRUDED TILE	53	6
OLD COUNTRY	56	
EXTRUDED TILE SKIRTING	57	
FLORENCE TILE	58	
SPANISH TILE	62	
INTER LOCK	64	
LAVA STONE	66	
BACKWOODS	68	
OMBRA	70	7
HOLO BLOCK	72	
VENTO SERIES	73	
THERMIC	74	
KENZAI PLUS	76	8
NOVA TILE	78	
GYPSY TILE	79	9
PERSIA	80	
QUART ROUND	81	
AMAZON TILE	82	
QUARTZ STONE	83	10
MONALISA	84	
K-BOND	86	
INSTALL METHOD	90	10
HOW & WHY	94	



KENZAI

PORCELAIN & CERAMIC TILES

a little



Big difference





Granite Tile : GF-206 / Color : White Granite

Granite Tile Is one of Kenzai tile first series and become the root of most Kenzai product line. The firing at high temperature (1250 °C) process makes strong body and durable tile. Granite tile has an extensive range of shapes and colors that help you to create a tile pattern that is a true reflection of you and your lifestyle. Granite tile is the most well-known and classic product line for Kenzai for more than 30 years.



Interior wall installation



Exterior wall installation



Interior floor installation



Exterior floor installation



Staircase installation



Installation with joint



Installation without joint

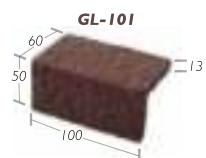
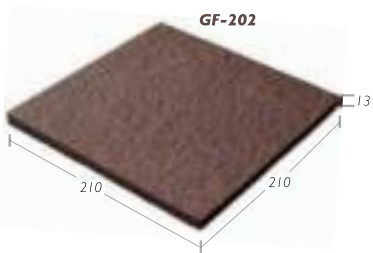
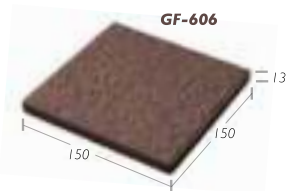
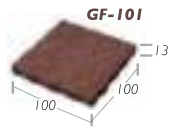
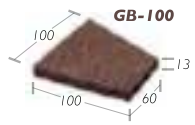
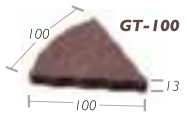

Granite Tile : GF-206 / Color : White Granite

COLORS



*ACTUAL COLORS MAY LOOK SLIGHTLY DIFFERENT DUE TO PRINTING

GRANITE TILE



Granite Tile : GF-206 / Color : New Gold



Granite Tile : GF-206 / Color : New Gold



Granite Tile : GF-206 / Color : New Gold



Granite Tile : GT-100, GB-100, GF-101 / Color : White Granite, Blue Bird, New Gold, Grey Leaden



Granite Tile : GT-100, GB-100, GF-101 / Color : White Granite, Blue Bird, New Gold, Grey Leaden

GRANITO PORCELAIN TILE



Granito Porcelain Tile : EX GF-606 / Color : Red Forest



Granito Porcelain Tile : EX GF-606 / Color : Red Forest, Black Sapphire

Granito Porcelain Tile

Granito tile has been developed from years of experience in producing exterior tiles. It passes standard tests from America (ASTM) and European Union (EN87). Its quality is internationally accepted for having low water absorption, heavy duty usage, and being strong and durable which makes it suitable for exterior decoration. It is appropriate to be used in car parks and driveways in residential and hotel projects that require extreme luxury. Decorating along walls, whether in a classical or modern style creates unique exquisiteness and therefore accepted from architects worldwide.

COLORS



White Champagne



Black Sapphire



Pigeon Grey



Green Valley



Red Forest



Copper Stone



Flamingo Pink



Wild Rose



Harvest Gold



Super Black



Autumn



Turquoise



Poppy Pink



Blue Canyon



Paradise Blue



Blue Carbon

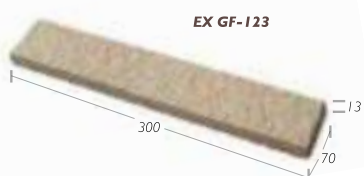
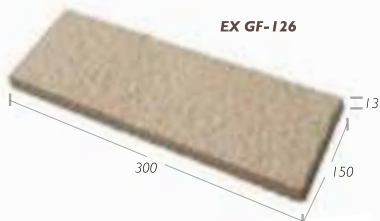
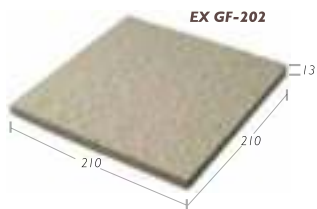
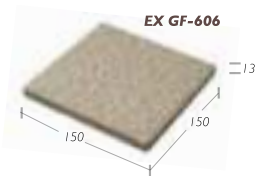
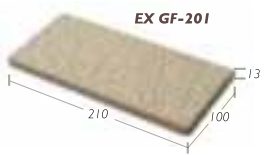
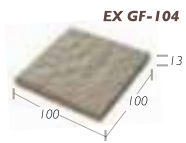
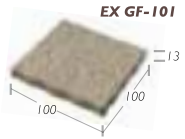
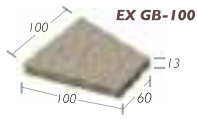
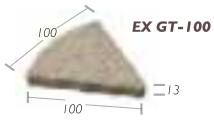

Granito Porcelain Tile : EX GF-101, EX GB-100 /
Color : White Champagne, Paradise Blue, Blue Canyon, Blue Carbon



Interior wall installation



Exterior wall installation



Interior floor installation



Exterior floor installation



Staircase installation



Installation with joint



Installation without joint

GRANITO PORCELAIN TILE (on-net)



Granito tile (on-net) is a product Kenzai especially designed with special technique to reduce labor workloads. This enhances convenience, speed, and efficiency in labor cost and time. Typically, any technicians could install Granito Tile (On-net) easily and therefore is suitable for jobs that require speed.

SCALLOP

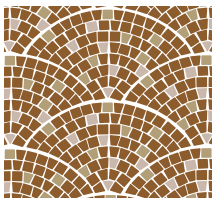

SQUARE



ADRIANA



MIMOZA

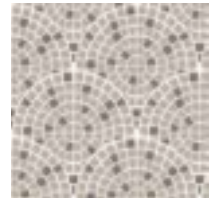

COMMON BRICK



HERRINGBONE

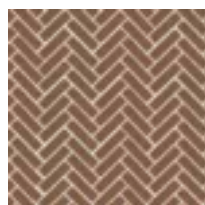

ICEBERG



ARMSTONE



MIMOZA

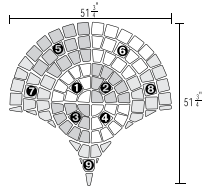
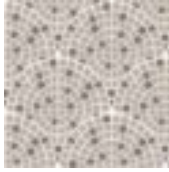

MIMOZA

1 Set = 0.99 Sq. M.
1 Ctn. = 1 Set

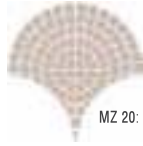

MZ 20: WHITE CHAMPAGNE



MZ 42: WILD ROSE +
COPPER STONE



MZ 22: PIGEON GREY +
WHITE CHAMPAGNE



MZ 45: WILD ROSE +
COPPER STONE +
AUTUMN

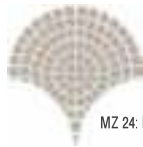

MZ 24: PIGEON GREY

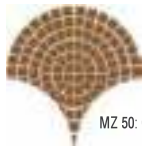

MZ 50: COPPER STONE



MZ 26: PIGEON GREY +
BLACK SAPPHIRE



MZ 53: COPPER STONE +
AUTUMN

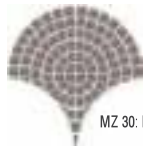

MZ 30: BLACK SAPPHIRE

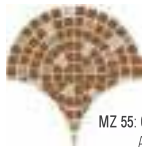

MZ 55: COPPER STONE +
AUTUMN +
WHITE CHAMPAGNE



MZ 32: BLACK SAPPHIRE +
PIGEON GREY

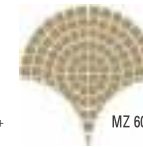

MZ 60: AUTUMN

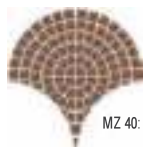

MZ 40: WILD ROSE



MZ 67: AUTUMN +
COPPER STONE

SCALLOP

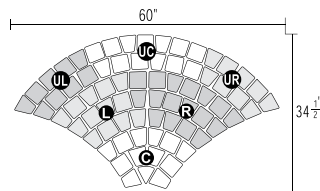
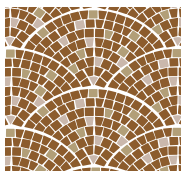

SCALLOP

1 Set = 0.81 Sq. M.
1 Ctn. = 1 Set



SC 20: WHITE CHAMPAGNE

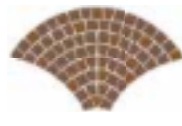

SC 42: WILD ROSE + COPPER STONE



SC 22: PIGEON GREY + WHITE CHAMPAGNE



SC 45: WILD ROSE + COPPER STONE +
AUTUMN



SC 24: PIGEON GREY



SC 50: COPPER STONE



SC 26: PIGEON GREY + BLACK SAPPHIRE



SC 53: COPPER STONE + AUTUMN



SC 30: BLACK SAPPHIRE



SC 55: COPPER STONE + AUTUMN +
WHITE CHAMPAGNE



SC 32: BLACK SAPPHIRE + PIGEON GREY



SC 60: AUTUMN

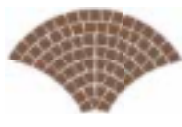

SC 40: WILD ROSE



SC 67: AUTUMN + COPPER STONE

GRANITO PORCELAIN TILE



Granito Porcelain Tile : EX GF-104 / Color : Black Sapphire, Pigeon Grey, White Champagne



Hexa Granito Tile : EX GF HX - 6 / Color : Super Black

COLORS

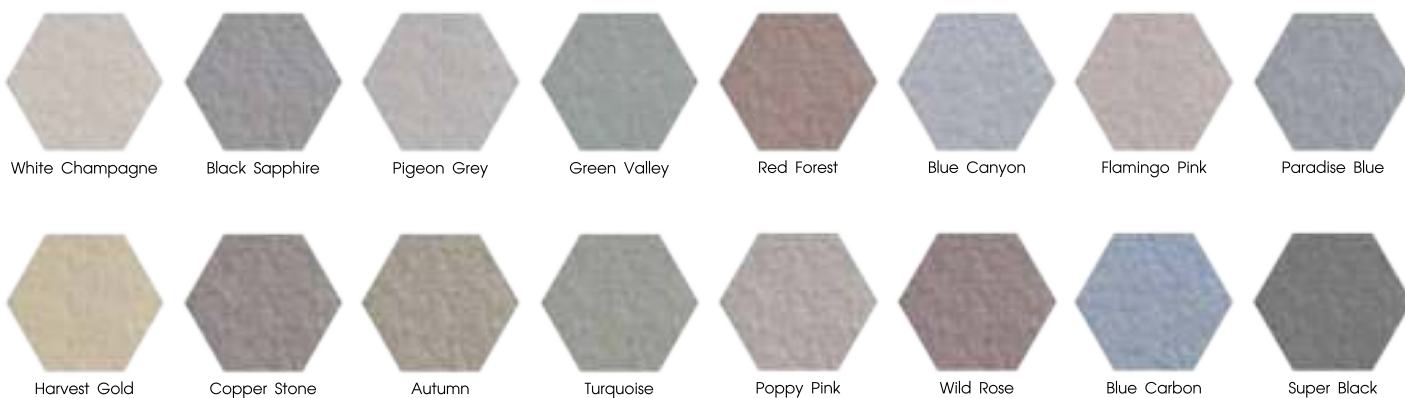

Hexa Granito Tile

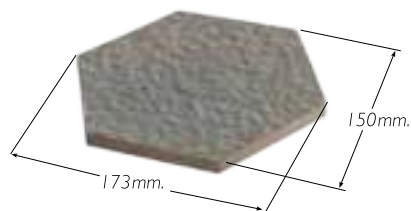

EX GF HX - 6

150 mm. x 173 mm. x 13 mm.

45 Pcs. / Sq.m.

25 Pcs. / Ctn.

Remark Pieces per Square Meter is calculated based on installation with 1 cm. joint



Rocky : RK-508 / Color : Red Forest

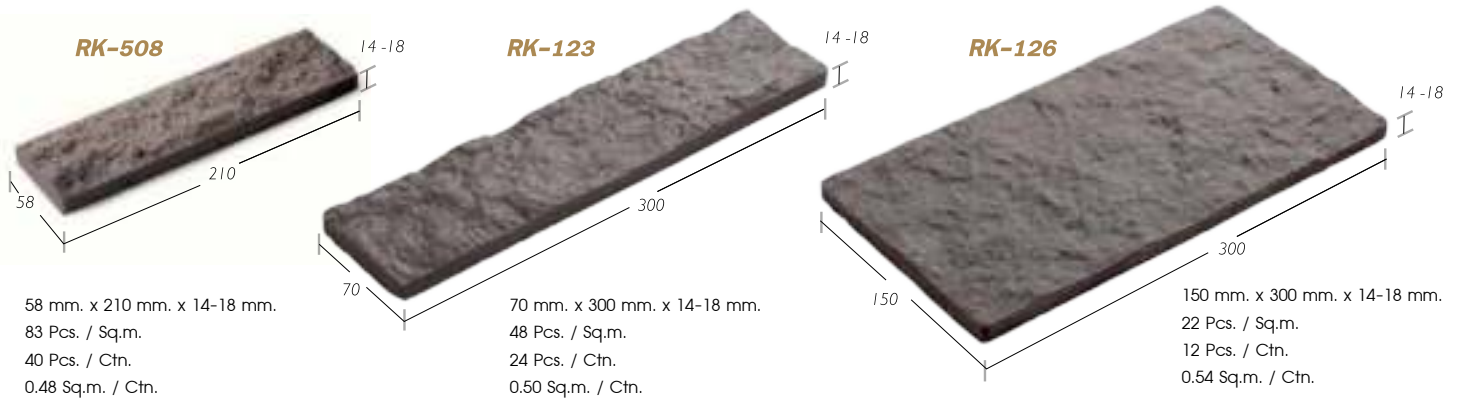



Rocky : RK-508 / Color : Pigeon Grey, White Champagne



Rocky

Has the mountainous rock surface in which each tile has dissimilar surface. This makes decoration with Rocky tiles to offer an impressive natural ambience wherever it is decorated.

Being a ceramic tile, Rocky can be clean easily without having to carry out the surface coating like natural stones and other similar objects.

COLORS



White Champagne



Pigeon Grey



Black Sapphire



Autumn



Harvest Gold



Flamingo Pink



Red Forest



Wild Rose



Turquoise



Paradise Blue



Interior wall installation



Exterior wall installation



Installation without joint

*ACTUAL COLORS MAY LOOK SLIGHTLY DIFFERENT DUE TO PRINTING



Harmony : HM-508 HM-108 / Color : Malaga, Smoky

HM-108



25 mm. x 210 mm. x 13-17 mm.
191 Pcs. / Sq.m.
100 Pcs. / Ctn.

HM-508



58 mm. x 210 mm. x 13-17 mm.
83 Pcs. / Sq.m.
50 Pcs. / Ctn.

Remark Pieces per Square Meter is calculated based on installation without joint.
In case HM-508 and HM-108 are used together, it would require 57 pcs. each/sam.

Harmony

The harmonization of nature, Kenzai create the Harmony as a luxury wall tile with natural ambience.

A homogeneous tile fired at 1,250 degree Celsius. It looks like natural stone while quality is higher and no fungus. Available in 7 colors and 2 different sizes.



In case HM-108 and HM-508 are used together, each will require 57 pcs/m²

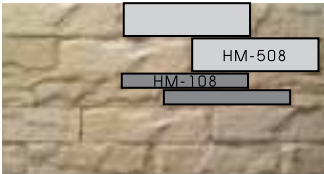

PATTERN A

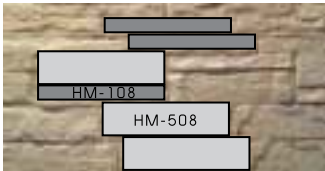

PATTERN B

1st - 2nd row of HM-108,
3rd row of HM-508, 4th row of HM-108, 5th-6th row of HM-508

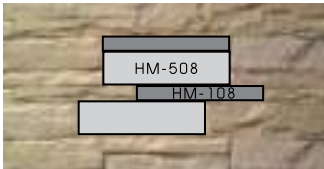

PATTERN C

1st row of HM-108, 2nd row of HM-508, 3rd row of HM-108, 4th row of HM-508



Harmony : HM-I08 / Color : Palm, Malaga

COLORS



Almond



Linen



Malaga



Palm



Camberly



Terra



Smoky

*ACTUAL COLORS MAY LOOK SLIGHTLY DIFFERENT DUE TO PRINTING



Harmony On Net : HM-03 / Color : Almond 50% Linen 50%



Harmony On Net : HM-01 / Color : Almond 100%

Harmony on net

Easy and convenient installation due to a combination of size and color which attached to the net and ready to use. The 10-11 sets are used for 1 square meter. The pattern is for a building and venue where require natural look.



Interior wall
installation



Exterior wall
installation



Installation
without joint

COLORS



HM-01 Almond 100%



HM-07 Malaga 100%



HM-02 Linen 100%



HM-08 Smoky 100%



HM-03 Almond 50% Linen 50%



HM-09 Malaga 50% Smoky 50%



HM-04 Camberry 100%



HM-10 Palm 100%



HM-05 Terra 100%



HM-11 Palm 50% Smoky 50%



HM-06 Camberry 50% Terra 50%

HARMONY (ON NET)

181 mm. x 420 mm. x 13-17 mm.

9 Set / 1 Ctn.

0.68 Sq.m. / Ctn.

Remark Pieces per Square Meter is calculated based on installation without joint



Marina : MR-109 / Color : White Champagne



Interior wall installation



Exterior wall installation



Installation without joint

Marina

The rough surface can create the look of tile, feature and pattern and more beautiful. The tiny pieces also fulfill the curve and narrow area. It can be used for interior and exterior decoration. Easy installation with less time spent. Available in 5 colors to mix and match to your own design.

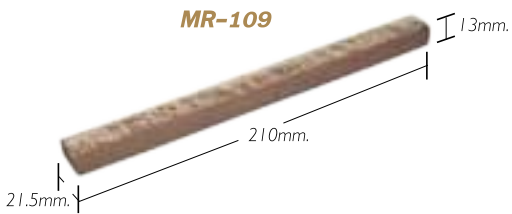

21.5 mm. x 210 mm. x 13 mm.
221 Pcs. / Sq.m.
150 Pcs. / Ctn.
0.68 Sq.m. / Ctn.

Remark Pieces per Square Meter is calculated based on installation without joint.



Marina : MR-109 / Color : White Champagne

COLORS



White Champagne



Pigeon Grey



Autumn



Copper Stone



Black Sapphire

*ACTUAL COLORS MAY LOOK SLIGHTLY DIFFERENT DUE TO PRINTING

COLORS



MR-01 White Champagne 100%



MR-02 Pigeon Grey 100%



MR-03 Pigeon Grey 50% White Champagne 50%



MR-04 Black Sapphire 100%



MR-05 Black Sapphire 65% Pigeon Grey 35%



MMR-06 Black Sapphire 50% White Champagne 50%



MR-07 Copper Stone 100%



MR-08 Copper Stone 50% Black Sapphire 50%



MMR-09 Copper Stone 50% Autumn 50%



MR-10 Pigeon Grey 50% Copper Stone 25% Autumn 25%



MRR-11 Autumn 50% White Champagne 50%



MR-12 Autumn 70% Black Sapphire 30%



MR-13 Copper Stone 40% White Champagne 30% Autumn 30%



MR-14 White Champagne 65% Copper Stone 35%



MR-15 Autumn 100%



Marina On Net : MMR-06 Black Sapphire 50% White Champagne 50%



Marina On Net : MMR-11
Autumn 50% White Champagne 50%

Marina on net

The rough surface makes an elegant wall. Easy installation due to the tiles are attached to the net and ready to use. Suitable for the curve and narrow area. It can be decorated for both interior and exterior. Easy installation with less time spent. The pattern can reduce work step, more convenient and minimize labor cost.



MARINA ON NET

159 mm. x 455 mm. x 13 mm.

10 Set / Ctn.

0.67 Sq.m. / Ctn.

Remark Pieces per Square Meter is calculated based on installation without joint



Colorado : CO-508 / Color : Copper Stone



Colorado

The wall tile which surface resembles split stone and offering variety of colors to choose from. It is easy for installation, cleaning and can be used with Granito and Rocky series. This gives your house's walls or building walls a natural ambience both internally and externally.



Interior wall installation



Exterior wall installation



Installation with joint



Installation without joint



Colorado : CO-508 / Color : Poppy Pink, Pigeon Grey

COLORS

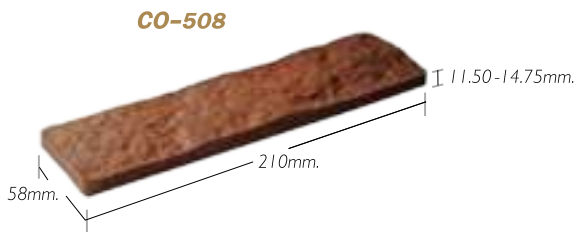

58 mm. x 210 mm. x 11.50 - 14.75 mm.
 67 Pcs. / Sq.m.
 60 Pcs. / Ctn.
 0.90 Sq.m. / Ctn.

*Remark Pieces per Square Meter is calculated based on installation with 1 cm. joint
 In case installation without joint, it would require 83 Pcs. / Sq. M.



Turquoise



White Champagne



Poppy Pink



Copper Stone



Autumn



Pigeon Grey



Wild rose



Black Sapphire



Paradise Blue

*ACTUAL COLORS MAY LOOK SLIGHTLY DIFFERENT DUE TO PRINTING



Colonial : CL-508 / Color : Autumn, Copper Stone, Black Sapphire



Colonial : CL-508 / Color : Autumn, Copper Stone

Colonial

Is a pride of Kenzai. The surface created in a modern luxury style with outstanding texture which makes more impression.

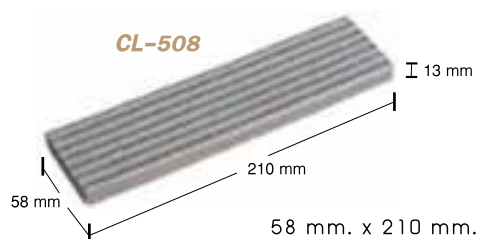

58 mm. x 210 mm. x 13 mm.

83 Pcs. / Sq.m.

60 Pcs. / Ctn.

0.72 Sq.m. / Ctn.

*Remark Pieces per Square Meter is calculated based on installation without joint



Colonial : CL-508 / Color : Autumn

COLORS



White Champagne



Pigeon Grey



Black Sapphire



Copper Stone



Autumn



Interior wall installation



Exterior wall installation



Installation without joint

*ACTUAL COLORS MAY LOOK SLIGHTLY DIFFERENT DUE TO PRINTING

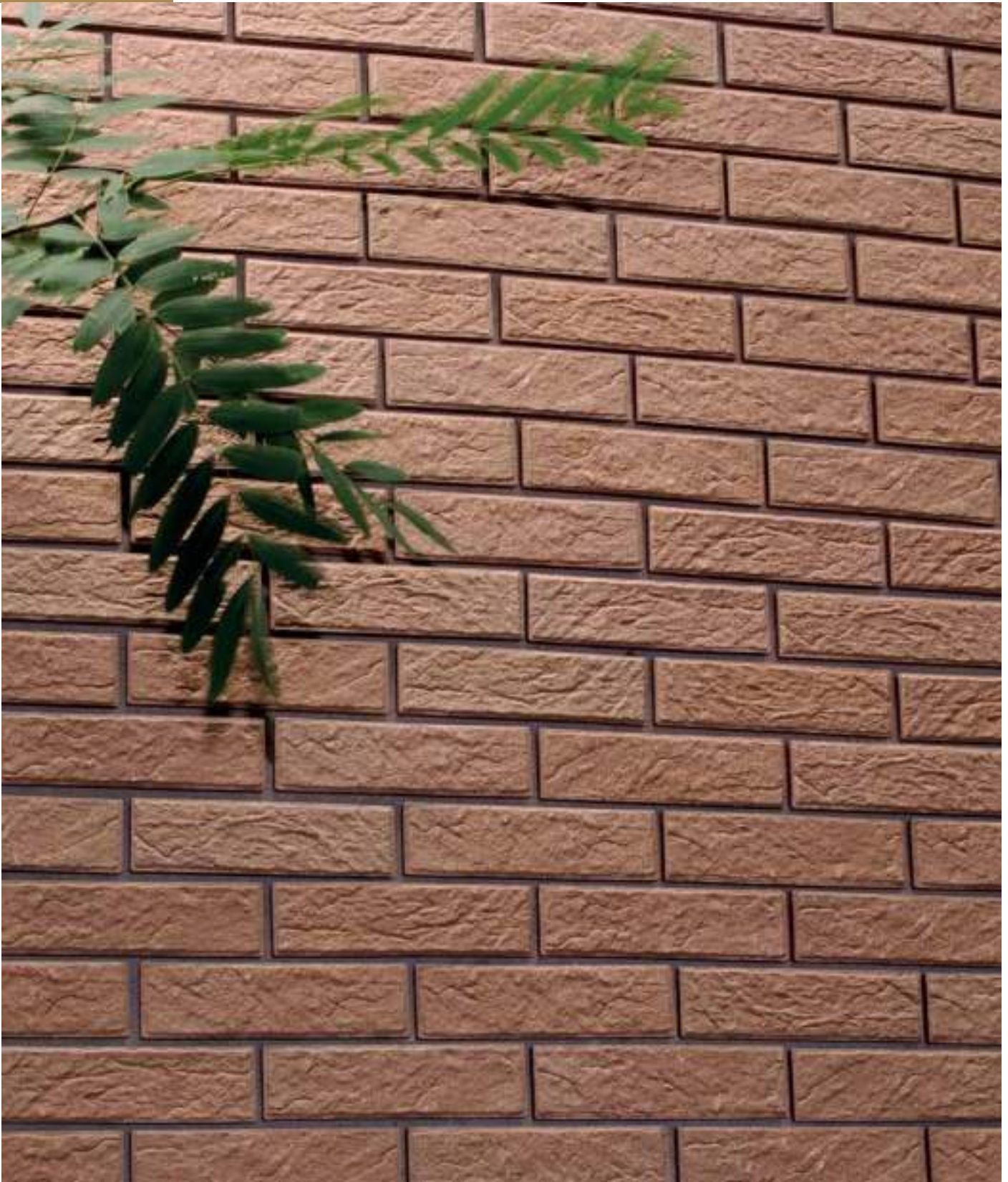

Victoria :VR-508 / Color : Montana Brown



Victoria

Victoria is the tile whose surface is not too smooth or too rough and is similar to Limestone. It is suitable for those who seek for natural atmosphere. It is offered in a variety of colors and it is easy to install just like other Kenzai tiles.



WALL / **Victoria** : VR-508 / Color : Cortina
 FLOOR / **Granito** : EX GF-202 / Color : Poppy Pink, Pigeon Grey

COLORS

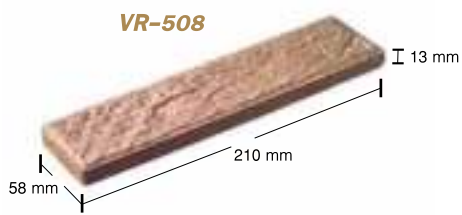

58 mm. x 210 mm. x 13 mm.
 67 Pcs. / Sq.m.
 60 Pcs. / Ctn.
 0.89 Sq.m. / Ctn.

*Remark Pieces per Square Meter is calculated based on installation with 1 cm. joint
 In case installation without joint, it would require 83 Pcs. / Sq. M.



Cortina



Montana Brown



Dakota



Panama



Camelot Grey



Ebony



Interior wall installation



Exterior wall installation



Installation with joint



Installation without joint

*ACTUAL COLORS MAY LOOK SLIGHTLY DIFFERENT DUE TO PRINTING



Iceberg / Color : White Champagne, Black Sapphire, Pigeon Grey

Iceberg

Is the created tile inspired by the mountainous rocks. With the characteristics of ceramic tile, Iceberg facilitates your endless imagination with a variety of colors and freedom sizes but still maintains its strength and durability that withstands the car's weight. This makes it suitable for garden decoration, wall decoration and driveways etc.



Iceberg 1



Diameter 4 inches
6 shapes
72 Pcs. / Sq. m.
36 Pcs. / Ctn.
0.50 Sq. m. / Ctn.

Iceberg 2



Diameter 6 inches
4 shapes
40 Pcs. / Sq. m.
20 Pcs. / Ctn.
0.50 Sq. m. / Ctn.

Iceberg 3



Diameter 8 inches
2 shapes
24 Pcs. / Sq. m.
12 Pcs. / Ctn.
0.50 Sq. m. / Ctn.

*Remark Pieces per Square Meter is calculated based on installation with 1.00 - 1.50 cm. joint

COLORS



White Champagne



Pigeon Grey



Black Sapphire



Copper Stone



Wild Rose

*ACTUAL COLORS MAY LOOK SLIGHTLY DIFFERENT DUE TO PRINTING



Iceberg / Color : White Champagne, Turquoise



Autumn



Poppy Pink



Turquoise



Paradise Blue



Interior wall installation



Exterior wall installation



Interior floor installation



Exterior floor installation

ARMSTONE



Armstone / Color : White Champagne, Wild Rose



Armstone

The ceramic tile that is similar to natural slate but has a much more variety of colors to choose from and its surface does not peel off like some natural stone do. It is easy to install, attractive and strong enough to withstand the car's weight. This makes it suitable for garden decoration, Wall decoration and driveways etc.

Armstone



Diameter 4 inches (approximate)
 6 shapes
 72 Pcs./ Sq. m.
 36 Pcs./ Ctn.
 0.50 Sq. m. / Ctn.

*Remark Pieces per Square Meter is calculated based on installation with 1.00 - 1.50 cm. joint

COLORS



White Champagne



Pigeon Grey



Black Sapphire



Copper Stone



Wild Rose

*ACTUAL COLORS MAY LOOK SLIGHTLY DIFFERENT DUE TO PRINTING



Armstone / Color : Copper Stone, Wild Rose



Armstone / Color : White Champagne, Black Sapphire



Autumn



Poppy Pink



Turquoise



Paradise Blue



Interior wall installation



Exterior wall installation



Interior floor installation



Exterior floor installation



Tuscany Stone :TUS-I45 / Color : Black Pearl

Tuscany Stone

A set of tile create modern luxury and unique style. It is designed for a convenient installation. Each set has different surface and size. Available in 4 patterns and colors for the use of interior and exterior to add more value and luxury to wall. Easy installation lighter than natural stone, durable.



Tuscany Stone :TUS-I45 / Color : Black Pearl



Interior wall installation



Exterior wall installation



Installation without joint



Tuscany Stone : TUS-145 / Color : White champagne

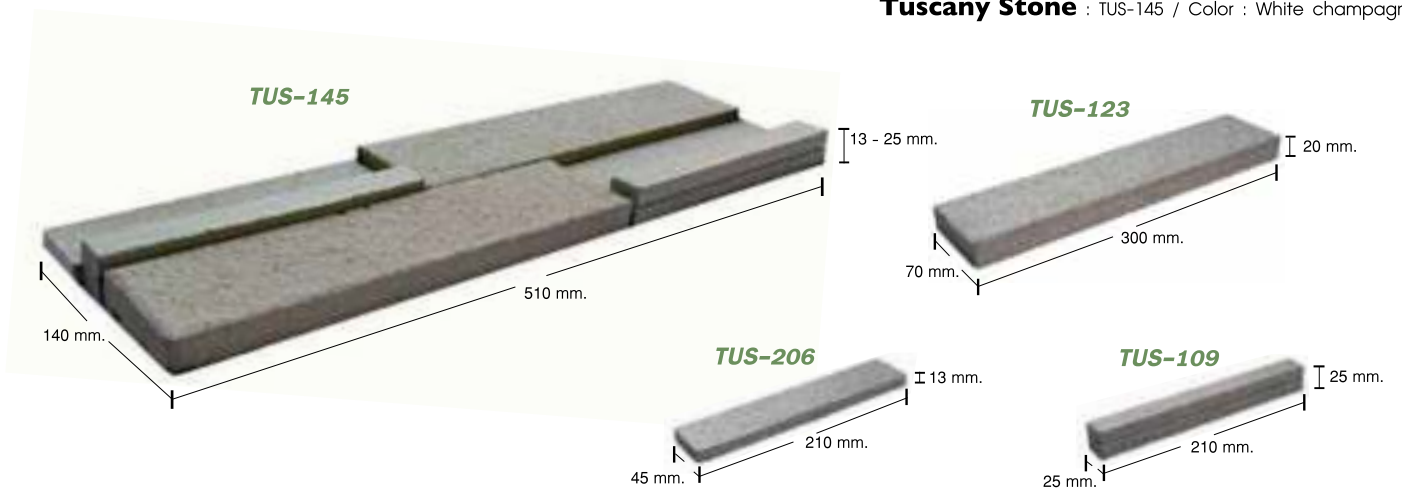

COLORS



White Champagne



Black Pearl



Cookie and Cream



Sahara Grey

*ACTUAL COLORS MAY LOOK SLIGHTLY DIFFERENT DUE TO PRINTING



Italian Modern Design : RKG-WH-04

Italian Modern Design

A set of tile with exclusive and classic look. The width, length higher create a deep dimension and different remarkable aspects. Each price of design and meshed together with special substance to prevent the misunderstanding of installing and pattern.



Interior wall installation



Exterior wall installation



Installation without joint

Colors & Pattern Combination

Model 1

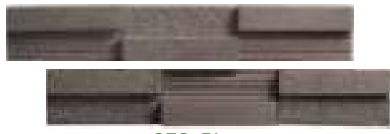

CEG-BL-01
0.52 Sq. M./Ctn. 8Sets/Ctn.

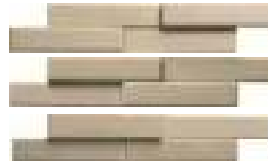

GGN-WH-02
0.45 Sq. M./Ctn. 8Sets/Ctn.

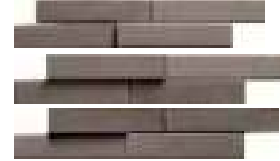

GGN-GL-02
0.45 Sq. M./Ctn. 8Sets/Ctn.

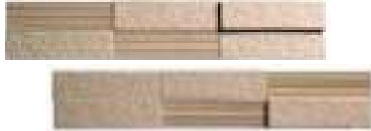

CEE-WH-17
0.58 Sq. M./Ctn. 8Sets/Ctn.



CEE-BL-17
0.58 Sq. M./Ctn. 8Sets/Ctn.

Model 2

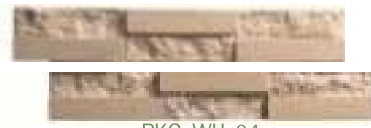

RKG-WH-04
0.52 Sq. M./Ctn. 8Sets/Ctn.



REG-BL-14
0.63 Sq. M./Ctn. 8Sets/Ctn.



CEE-PG-17
0.52 Sq. M./Ctn. 8Sets/Ctn.

Model 3



CMR-WH-07
0.58 Sq. M./Ctn. 8Sets/Ctn.



HEG-HV-12
0.51 Sq. M./Ctn. 8Sets/Ctn.



CMG-PG-13
0.62 Sq. M./Ctn. 8Sets/Ctn.



RHE-RD-15
0.63 Sq. M./Ctn. 8Sets/Ctn.

Italian Modern Design

Available in 12 series, each created in 6 different styles reflecting the unlimited imagination. Free to design as desired. Easy to installation, lighter than natural stone, durable and free from fungus.

NAPOLIE STONE



Napolie Stone : NAP-101 / Color : Jamica White, Rebecca Red, Savana Brown

NAP NT-100



100 x 100 x 13 mm.
60 Pcs. / Ctn.

NAP NB-100



100 x 100 x 68 x 13 mm.
90 Pcs. / Sq.m.
70 Pcs. / Ctn.
0.78 Sq.m. / Ctn.

NAP-101



100 x 100 x 13 mm.
80 Pcs. / Sq.m.
60 Pcs. / Ctn.
0.75 Sq.m. / Ctn.

NAP-104



100 x 100 x 13 mm.
80 Pcs. / Sq.m.
60 Pcs. / Ctn.
0.75 Sq.m. / Ctn.

NAP-202



210 x 210 x 13 mm.
21 Pcs. / Sq.m.
16 Pcs. / Ctn.
0.76 Sq.m. / Ctn.



Napolie Stone : NAP-101, NAP NB -100 / Color : Savana Brown

COLORS



Napolie Stone

The tile whose beauty transcends the beauty of typical stone. Various colors are offered. Easy to install with the thickness being only 13 mm. Napolie stone is suitable in displaying exceptional European home style.



*ACTUAL COLORS MAY LOOK SLIGHTLY DIFFERENT DUE TO PRINTING



Fuji Tile : FJ-508 / Color : Bone

Fuji Tile

One of Kenzai's innovative ceramic tiles that reflect natural beauty in harmony with luxury and fascination of Japanese style. Fuji tile has a high degree of breaking strength, chemical resistance and glossy surface which makes it easy to clean and maintenance. Fuji tile can be used on any floor/wall area to enhance your decorating idea. Fuji tile will fulfill the beauty of your house and make it pleasant and more attractive to live in.

COLORS



Bone



Purple Black



Golden Sand



Almond



Rosita



Narada



Ocean Blue 1



Ocean Blue 2



Interior wall installation



Exterior wall installation



Interior floor installation



Exterior floor installation



Staircase installation



Installation with joint



Installation without joint



Fuji Tile : FJ-101 / Color : Bone

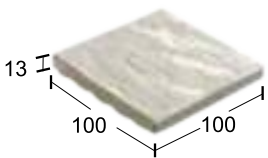

FJ-101

100 mm. x 100 mm. x 13 mm.
80 Pcs. / Sq.m.
60 Pcs. / Ctn.

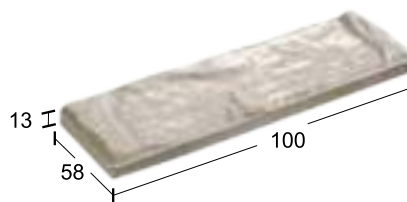

FJ-508

58 mm. x 210 mm. x 13 mm.
67 Pcs. / Sq.m.
60 Pcs. / Ctn.

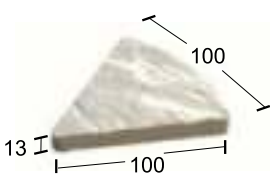

FJ FT-100

100 mm. x 100 mm. x 13 mm.
60 Pcs. / Ctn.

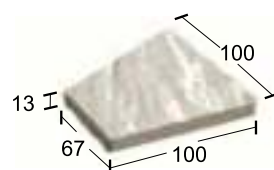

FJ FB-100

67 mm. x 100 mm.
x 100 mm. x 13 mm.
90 Pcs. / Sq.m.
70 Pcs. / Ctn.

Remark Pieces per Square Meter is calculated based on installation with 1 cm. joint

HEXA TILE



Hexa Tile : HEXA-6 / Colour : Lemon, Navy Blue, Sterling, Almond

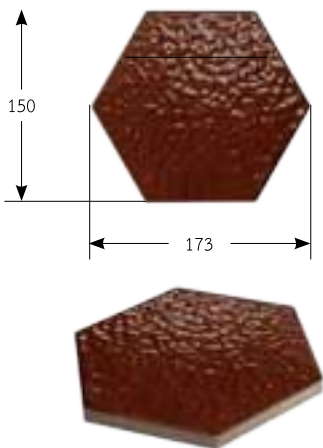

Hexa Tile

Is a geometric shape that never out of trend based on its patterns and colors. It can create time wall and floor after stylish pattern using in Italian architecture. Kenzai's Hexa tile has various groups of colors such as "Metallic" which similar to metal like colors, "Vintage" that has vintage style color, "Japanese colorful" that has a colorful of Japanese kimono style and "Rainbow" for a rainbow tone. The design can be simple as one color or can have complexity of patterns and colors according to your own style and can be design to match with young generation style. Hexa tile will amaze you and make you proud of your own creation style.

HEXA-6

150 mm. x 173 mm. x 13 mm.

45 Pcs. / Sq.m.

25 Pcs. / Ctn.

Remark Pieces per Square Meter is calculated based on installation with 1 cm. joint

Hexa Tile Rainbow

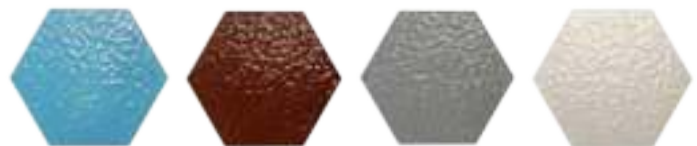

Marine Blue

Brown Sugar

Sterling

Almond



Interior wall installation



Exterior wall installation



Interior floor installation



Exterior floor installation



Installation with joint



Hexa Tile : HEXA-6 / Color : Almond, Sterling, Golden Shower, Marigold

Hexa Tile Japanese Colorful

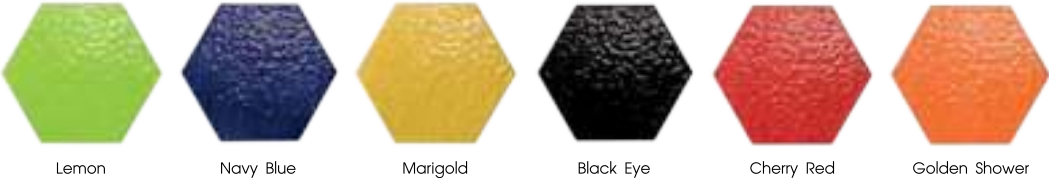

Lemon Navy Blue Marigold Black Eye Cherry Red Golden Shower

Hexa Tile Vintage

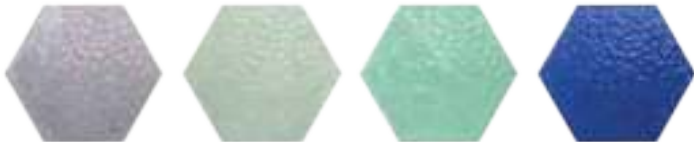

Nikel Nite Mist India Green Pacific Blue

Hexa Tile Metallic



Copper Oxide Metallic Black

*ACTUAL COLORS MAY LOOK SLIGHTLY DIFFERENT DUE TO PRINTING

NINE IN ONE



Nine in One : NO-9/1 / Color : Autumn

Nine in One

A decorative ceramic floor tile that has nine different sizes in one set will bring back the opulence atmosphere of ancient Roman Street to your area. Kenzai added special properties to 9 in 1 series, which make it strong, highly resistance to chemical, able to withstand the weight of vehicle and more durable than natural stone. 9 in 1 has its unique beauty with various colors that give your home prominently and perfectly decorated.

COLORS



White Champagne

Pigeon Grey

Autumn

Sahara Grey

Cookie and Cream

Copper Stone

Wild Rose

Black Pearl



No.1

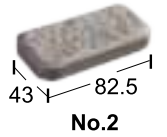

No.2

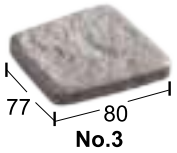

No.3

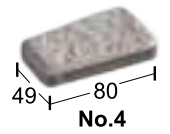

No.4

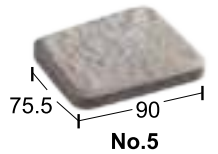

No.5

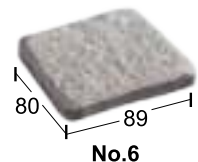

No.6

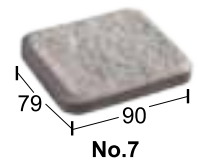

No.7

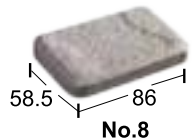

No.8

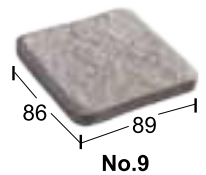

No.9

NO-9/1

135 Pcs. / Sq.m.

135 Pcs. / Ctn.

9in1 (on net)

1.05 Sq.m. / Ctn.

8 Set / Ctn.

Remark Pieces per Square Meter is calculated based on installation with 1 cm. joint



Interior floor installation



Exterior floor installation



Installation with joint



Nine in One (on net) : NIO-27 / Color : Pigeon Grey 80% Cookie and Cream 20%

9in1
 Nine in One
 (on net)



NIO - 20
 White Champagne 100%



NIO - 24
 Pigeon Grey 100%



NIO - 60
 Autumn 100%



NIO - 16
 Sahara Grey 100%



NIO - 17
 Cookie and Cream 100%



NIO - 50
 Copper Stone 100%



NIO - 40
 Wild Rose 100%



NIO - 18
 Black Pearl 100%



NIO - 27
 Pigeon Grey 80%
 Cookie and Cream 20%



NIO - 68
 Sahara Grey 80%
 Black Pearl 20%



NIO - 78
 Cookie and Cream 80%
 Black Pearl 20%



NIO - 53
 Copper Stone 80%
 Autumn 20%



NIO - 42
 Wild Rose 80%
 Copper Stone 20%



NIO - 28
 White Champagne 80%
 Pigeon Grey 10%
 Cookie and Cream 10%



NIO - 45
 Wild Rose 80%
 Copper Stone 10%
 Autumn 10%

*ACTUAL COLORS MAY LOOK SLIGHTLY DIFFERENT DUE TO PRINTING

COLORS



NARITA : NR-101 / Color : Yellow

Narita Tile

Narita is inspired by the combination of cliff's rock. It has been widely accepted due to its low water absorption, durability and strength. Thus makes Narita widely accepted from architects and designer, great for landscaping, housing project and driveway.

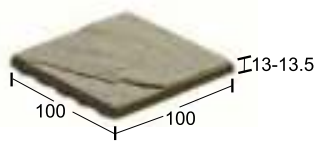

NR-101

100 mm. x 100 mm.
x 13.0 -13.5 mm.
80 Pcs./Sq.m.
60 Pcs./Ctn.

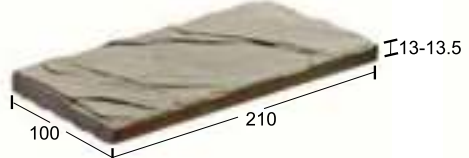

NR-201

100 mm. x 210 mm.
x 13.0 -13.5 mm.
40 Pcs./Sq.m.
30 Pcs./Ctn.

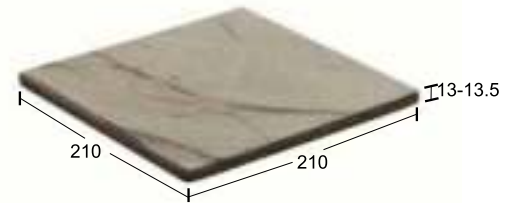

NR-202

210 mm. x 210 mm.
x 13.0 -13.5 mm.
21 Pcs./Sq.m.
16 Pcs./Ctn.

Remark Pieces per Square Meter is calculated based on installation with 1 cm. joint



MELBOURNE



MELBOURNE : MB-508, MB-206, MB-108 / Color : Black

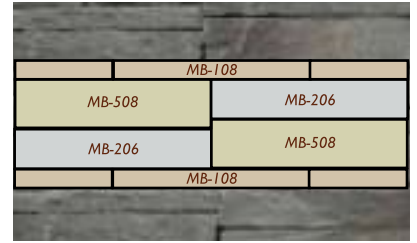

MB – 508, MB – 206 and MB – 108 each will be require 38 Pcs. / Sq. M.

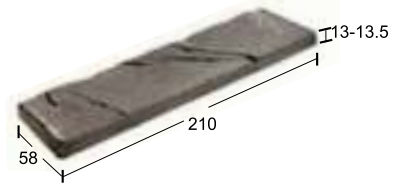

MB-508

58 mm. x 210 mm.
x 13.0-13.5 mm.
83 Pcs./Sq.m.
60 Pcs./Ctn.



MB-206

45 mm. x 210 mm.
x 13.0-13.5 mm.
106 Pcs./Sq.m.
60 Pcs./Ctn.



MB-108

25 mm. x 210 mm.
x 13.0-13.5 mm.
191 Pcs./Sq.m.
100 Pcs./Ctn.

Melbourne

Melbourne series is great combination of different sizing thus creates the simple but unique impression. With its smooth texture creates a simplicity but extraordinary for your home.

COLORS



White



Grey



Brown



Yellow



Pink



Green



Black



Red

*ACTUAL COLORS MAY LOOK SLIGHTLY DIFFERENT DUE TO PRINTING



Interior wall installation



Exterior wall installation



Installation with joint



Installation without joint

5



PHOENIX : PN-508, PN-206, PN-109 / Color : Mountain Grey

COLORS



Light Cream



Mountain Grey

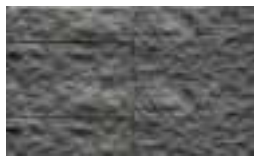

Black Sheep



Swiss Gold



Sugar Brown

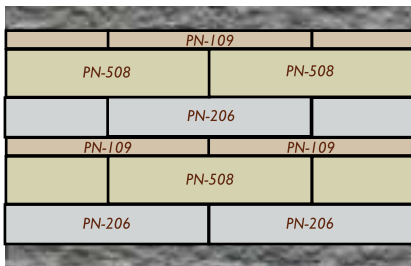

PN – 508, PN – 206 and PN – 109
each will be require 40 Pcs. / Sq. M.

Phoenix

Phoenix is inspired by the roughness of the split surface stone but more durable, easy to maintenance due to high temperature firing. With its rough texture creates an extravagance for your precious home.



PN-508

58 mm. x 210 mm.
x 15.0-16.8 mm.
83 Pcs./Sq.m.
40 Pcs./Ctn.

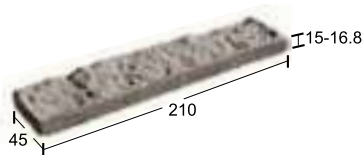

PN-206

45 mm. x 210 mm.
x 15.0-16.8 mm.
106 Pcs./Sq.m.
50 Pcs./Ctn.



PN-109

19 mm. x 210 mm.
x 15.0-16.8 mm.
250 Pcs./Sq.m.
130 Pcs./Ctn.

*ACTUAL COLORS MAY LOOK SLIGHTLY DIFFERENT DUE TO PRINTING

*Remark Pieces per Square Meter is calculated based on without joint installation. In case PN – 508, PN – 206 and PN – 109 are used together, each will be require 40 Pcs. / Sq. M.



LUGA : LU-204 / Color : Black Pearl

COLORS



White Champagne

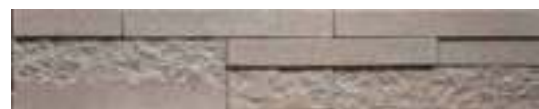

Sahara Grey



Black Pearl



LU-204

100 mm. x 525 mm. x 13 mm.
19 Set/Sq.m.
10 Set/Ctn.

Remark Pieces per Square Meter is calculated based on installation without joint



Interior wall installation



Exterior wall installation



Installation without joint



GRANITE G : GG-508 / Color : Simon Gold



GG-508

58 mm. x 210 mm. x 13 mm.
67 Pcs. / Sq.m.
60 Pcs. / Ctn.

*Remark Pieces per Square Meter is calculated based on installation with 1 cm. joint.
In case GG - 508 install without joint each will be require 83 Pcs. / Sq. M.

Granite G

Granite G series' classical design, creates eternal beauty with its variety of colors can be combined. With its durability and homogeneity will make your home beauty last forever.

COLORS



*ACTUAL COLORS MAY LOOK SLIGHTLY DIFFERENT DUE TO PRINTING





6

Extruded Tile : F-206 / Color : Charcoal



Extruded Tile : F-201, F-206 / Color : Wine Red

F-106

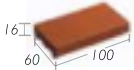

60 mm. x 100 mm. x 16 mm.
130 Pcs. / Sq.m.
100 Pcs. / Ctn.
0.77 Sq.m. / Ctn.

F-206



60 mm. x 210 mm. x 16 mm.
65 Pcs. / Sq.m.
50 Pcs. / Ctn.
0.77 Sq.m. / Ctn.

F-101

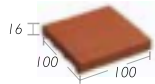

100 mm. x 100 mm. x 16 mm.
80 Pcs. / Sq.m.
60 Pcs. / Ctn.
0.75 Sq.m. / Ctn.

F-201



100 mm. x 210 mm. x 16 mm.
40 Pcs. / Sq.m.
30 Pcs. / Ctn.
0.75 Sq.m. / Ctn.

F-606

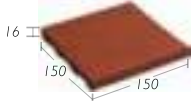

150 mm. x 150 mm. x 16 mm.
38 Pcs. / Sq.m.
20 Pcs. / Ctn.
0.53 Sq.m. / Ctn.

F-202

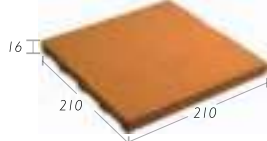

210 mm. x 210 mm. x 16 mm.
21 Pcs. / Sq.m.
10 Pcs. / Ctn.
0.48 Sq.m. / Ctn.

Extruded Tile

Extruded Tile - has been fired at 1,250 °C, which makes it stronger than other extruded tiles in the market. It can be decorated for both floor and wall. It is qualified for heavy duty usage such as car park and withstanding acid and base while maintaining warmth in a classic European style.

C-206



45 mm. x 60 mm. x 210 mm. x 16 mm.
5 Pcs. / M.
30 Pcs. / Ctn.
6 M. / Ctn.

S-201



45 mm. x 100 mm. x 210 mm. x 16 mm.
5 Pcs. / M.
20 Pcs. / Ctn.
4 M. / Ctn.



Interior wall installation



Exterior wall installation



Interior floor installation



Exterior floor installation



Installation with joint



Staircase installation



Extruded Tile : F-201 / Color : White



45 mm. x 60 mm. x 100 mm. x 16 mm.
15 Pcs. / M.
80 Pcs. / Ctn.
5.33 M. / Ctn.

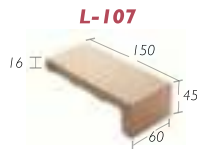

45 mm. x 60 mm. x 150 mm. x 16 mm.
15 Pcs. / M.
40 Pcs. / Ctn.
2.67 M. / Ctn.

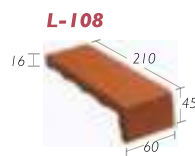

45 mm. x 60 mm. x 210 mm. x 16 mm.
15 Pcs. / M.
40 Pcs. / Ctn.
2.67 M. / Ctn.

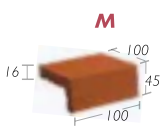

45 mm. x 100 mm. x 100 mm. x 16 mm.
10 Pcs. / M.
60 Pcs. / Ctn.
6 M. / Ctn.

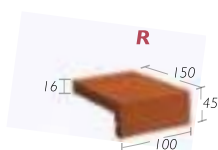

45 mm. x 100 mm. x 150 mm. x 16 mm.
10 Pcs. / M.
18 Pcs. / Ctn.
1.80 M. / Ctn.

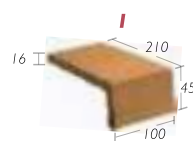

45 mm. x 100 mm. x 210 mm. x 16 mm.
10 Pcs. / M.
18 Pcs. / Ctn.
1.80 M. / Ctn.

OLD COUNTRY



Old Country : AF-206 / Color : Smoky White

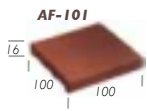

100 mm. x 100 mm. x 16 mm.
80 Pcs. / Sq.m.
60 Pcs. / Ctn.
0.75 Sq.m. / Ctn.

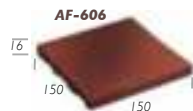

150 mm. x 150 mm. x 16 mm.
38 Pcs. / Sq.m.
20 Pcs. / Ctn.
0.53 Sq.m. / Ctn.

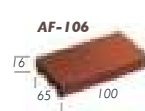

65 mm. x 100 mm. x 16 mm.
121 Pcs. / Sq.m.
100 Pcs. / Ctn.
0.83 Sq.m. / Ctn.



45 mm. x 65 mm. x 100 mm. x 16 mm.
14 Pcs. / Sq.m.
80 Pcs. / Ctn.
5.71 M. / Ctn.



65 mm. x 210 mm. x 16 mm.
60 Pcs. / Sq.m.
50 Pcs. / Ctn.
0.83 Sq.m. / Ctn.

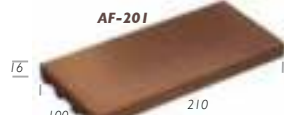

100 mm. x 210 mm. x 16 mm.
40 Pcs. / Sq.m.
30 Pcs. / Ctn.
0.78 Sq.m. / Ctn.

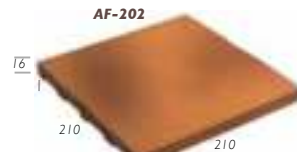

210 mm. x 210 mm. x 16 mm.
21 Pcs. / Sq.m.
10 Pcs. / Ctn.
0.48 Sq.m. / Ctn.

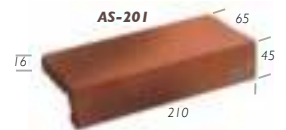

65 mm. x 210 mm. x 16 mm.
5 Pcs. / Sq.m.
20 Pcs. / Ctn.
4 M. / Ctn.

COLORS



Foggy Grey

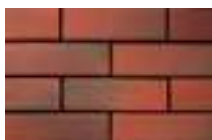

Red wood

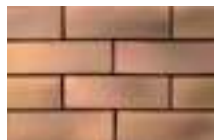

Chadow Brown



Smoky White



Solar Eclipse



Extruded Tile : K-201 / Color : Wine Red

6

Extruded Tile : Skirtings Series

Extruded tile for wall decoration to prevent the stain and dirt from cleaning process and cover the joint between wall and floor.



COLORS

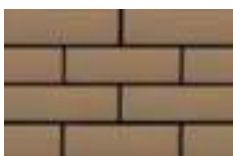

Bricky Brown

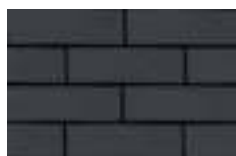

Charcoal

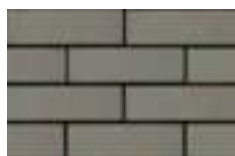

Silver Grey

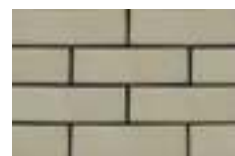

White

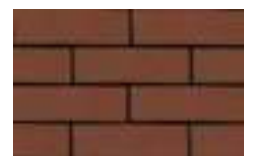

Wine Red



Florence Tile : FF-808 / Color : Roza

FL-404

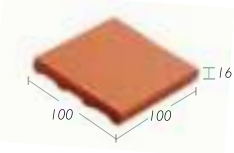

4 Inch x 4 Inch
100 x 100 x 16 mm.
80 Pcs. / Sq.m.
60 Pcs. / Ctn.
0.75 Sq.m. / Ctn.

FF-206

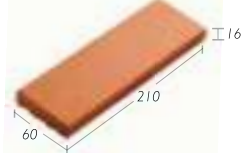

2 Inch x 8 Inch
60 x 210 x 16 mm.
65 Pcs. / Sq.m.
50 Pcs. / Ctn.
0.77 Sq.m. / Ctn.

FF-201

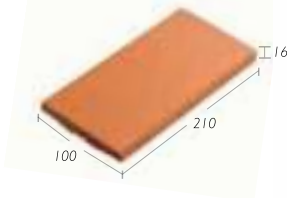

4 Inch x 8 Inch
100 x 210 x 16 mm.
40 Pcs. / Sq.m.
30 Pcs. / Ctn.
0.75 Sq.m. / Ctn.

FF-808

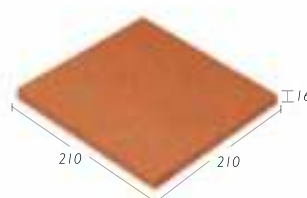

8 Inch x 8 Inch
210 x 210 x 16 mm.
21 Pcs. / Sq.m.
10 Pcs. / Ctn.
0.48 Sq.m. / Ctn.

FS-608



6 Inch x 8 Inch
150 x 210 x 16 mm.
5 Pcs. / m.
9 Pcs. / Ctn.
1.80 m. / Ctn.

FL-303

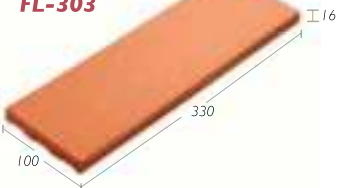

4 Inch x 13 Inch
100 x 330 x 16 mm.
3 Pcs. / m.
6 Pcs. / Ctn.
2 m / Ctn.

FF-130

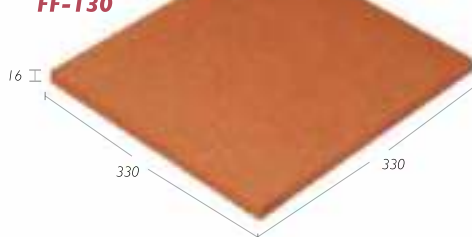

13 Inch x 13 Inch
330 x 330 x 16 mm.
9 Pcs. / Sq.m.
5 Pcs. / Ctn.
0.56 Sq.m. / Ctn.

FS-130



6 Inch x 13 Inch
150 x 330 x 16 mm.
3 Pcs. / m.
6 Pcs. / Ctn.
2 m / Ctn.

Remark Pieces per Square Meter is calculated based on installation with 1 cm. joint



Florence Tile : FS-608, FF-808 / Color : Apricot

COLORS



Roza



Apricot

Florence Tile

Is terracotta tile that has just the right smoothness not too slippery and not too rough with the color tone of Terracotta, it gives the atmosphere of warmth and relaxation like Mediterranean home style. It is suitable for dining room, bedroom, living room, showroom, or even exterior decoration like walkway, terrace and pool deck.

*ACTUAL COLORS MAY LOOK SLIGHTLY DIFFERENT DUE TO PRINTING



Interior wall installation



Exterior wall installation



Interior floor installation



Exterior floor installation



Installation with joint



Staircase installation

DECORATION TILE



Florence Tile : FF-I30, FF-404 Fiore / Color : Roza

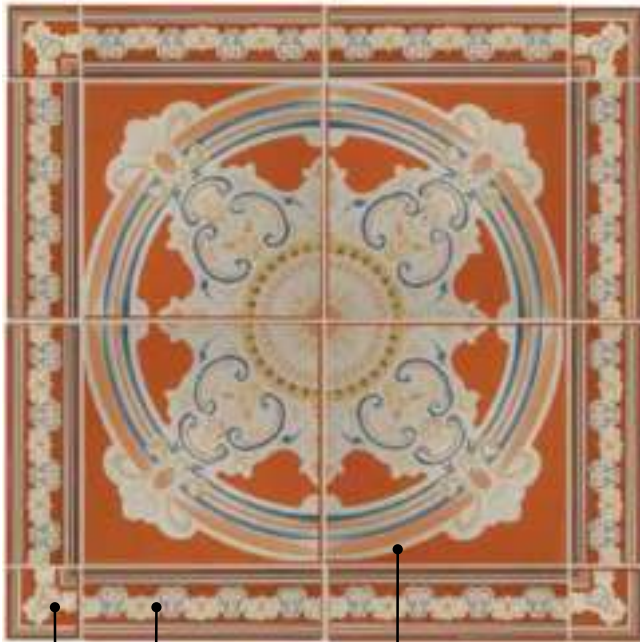

FL-404 FL-303 SIENA FL-130 SIENA

FL-404 FL-303 FIORE FL-130 FIORE

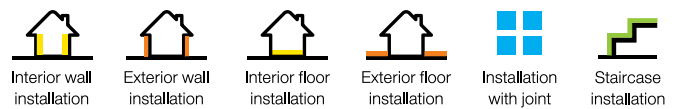

*ACTUAL COLORS MAY LOOK SLIGHTLY DIFFERENT DUE TO PRINTING

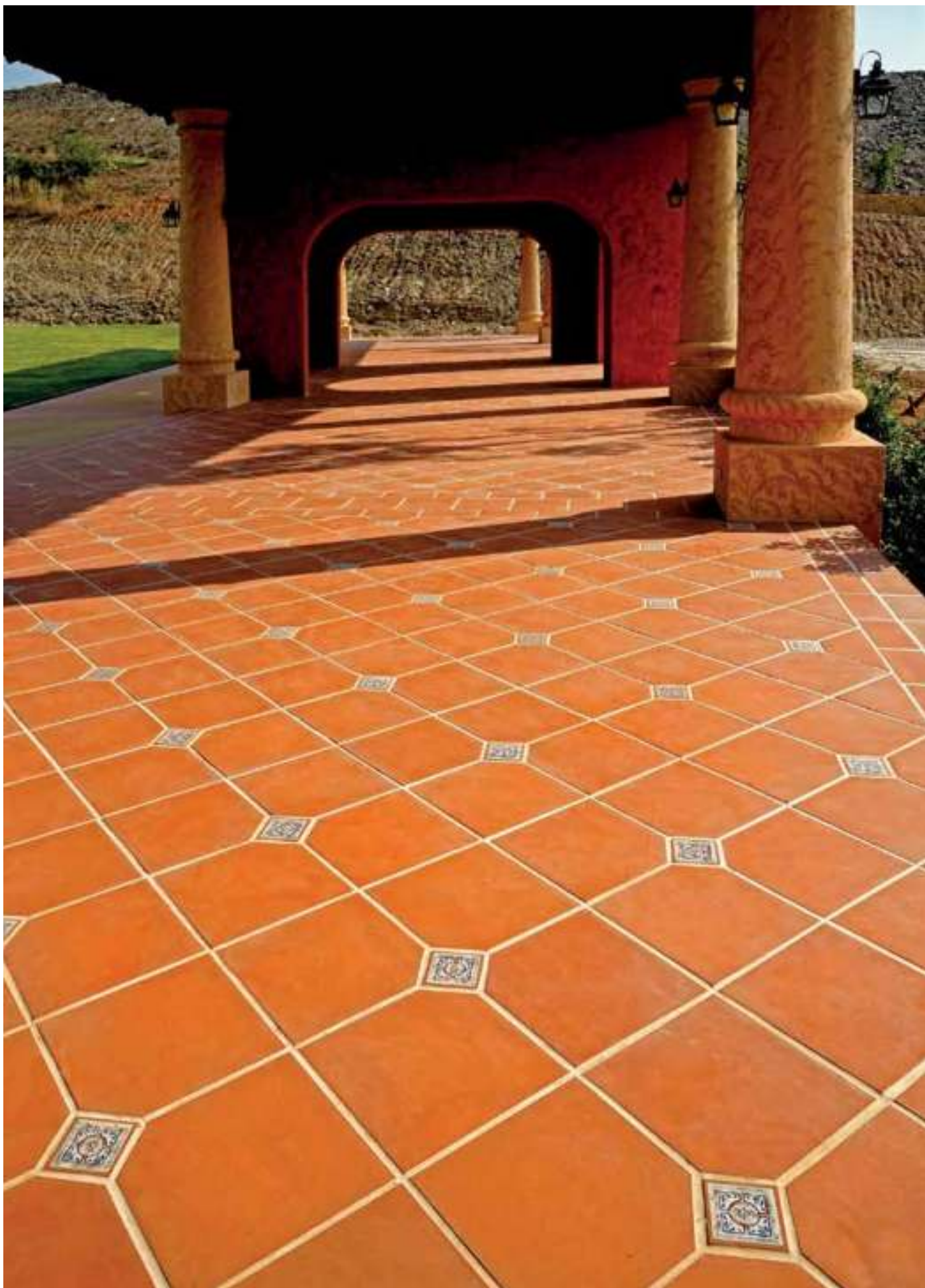

Florence Tile : FF-130, FF-404 Valencia / Color : Roza

SPANISH TILE



Spanish Tile : SP-206 / Color : Cinnamon

COLORS



Dusty Rose



Cinnamon



White Truffle



Grey Dust



Black Pepper



Black Coffee



White Linen



Spanish Tile : SP-206 / Color : Dusty Rose

Spanish Tile

Will enhance the feel of classic vintage looks on a wall. It also has all the main characteristic of Kenzai tile quality such as strong body due to the high temperature firing 1,250 °C chemical resistance, low water absorption which makes you less concern of bacteria and fungus that may appear on the surface of tile. Spanish tile will create a classy atmosphere to your home.



Spanish Tile : SP-206 / Color : Dusty Rose



60 mm. x 210 mm. x 16 mm.
 65 Pcs. / Sq. M.
 50 Pcs. / Ctn.
 0.77 Sq. M. / Ctn.

*Remark Pieces per Square Meter is calculated based on installation with 1 cm. joint





Inter Lock : HT-201 / Color : White, Brick Brown



Inter Lock

Is a premium quality of extruded tile that fired at high temperature 1,250 °C to make a strong body and resistant to bacteria. The principle characteristic is that can lay to any type of wall without adhesive cement, easy to install, resistant to the vibration. Tile will not lost or fall off. It can also reflect heat from the outside and fit with many house design. Inter look will add a perfect feeling of quality and style to your home.

COLORS



White

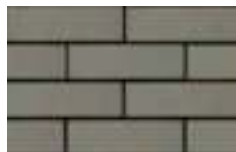

Silver Grey



Wine Red



Bricky Brown

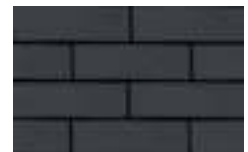

Charcoal



Smoky White



Foggy Grey

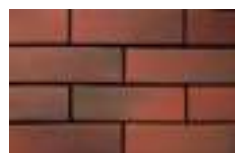

Red Wood

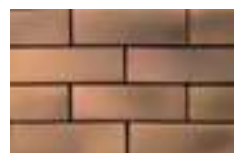

Chadow Brown

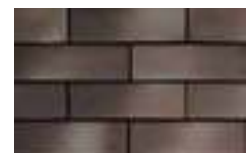

Solar Eclipse



Inter Lock : HT-201 / Color : Red Wood

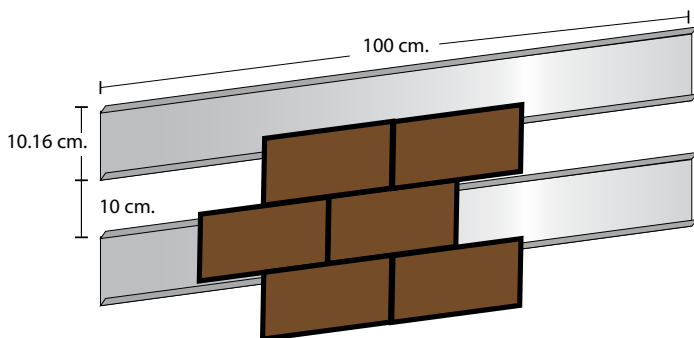

100 mm. x 230 mm. x 20 mm.
43 Pcs. / Sq.m.
14 Pcs. / Ctn.
0.33 Sq.m. / Ctn.

Remark Pieces per Square Meter is calculated based on installation without joint



The pattern of Inter Lock installation on all type of wall. Use aluminum rail to attach tile to the wall. Easy to install, dry process and less time consumption.



Interior wall installation



Exterior wall installation

LAVA STONE



Lava Stone : LAVA-206, LAVA-406 / Color : Coral

Lava Stone

Extruded is tile that passed splitting process and create the resemblance of decorative natural stone which have utmost nature sensation in color shades along with the surface.

Design Pattern



PATTERN A



PATTERN B



PATTERN C



PATTERN D



PATTERN E



PATTERN F



Lava Stone : LAVA-206, LAVA-406 / Color : Polar White



Interior wall
installation



Exterior wall
installation



Installation
without joint



Lava Stone : LAVA-206, LAVA-406 / Color : Polar White

COLORS



Polar White



Coral



Midnight Sky

LAVA-206



65 x 245 x 25-41 mm.
62 Pcs. / Sq.m.
30 Pcs. / Ctn.
0.48 Sq.m / Ctn.

LAVA-406



45 x 245 x 25-41 mm.
91 Pcs. / Sq.m.
48 Pcs. / Ctn.
0.53 Sq.m. / Ctn.

LAVA-213



65 x 330 x 25-41 mm.
46 Pcs. / Sq.m.
20 Pcs. / Ctn.
0.43 Sq.m. / Ctn.

LAVA-413



45 x 330 x 25-41 mm.
67 Pcs. / Sq.m.
30 Pcs. / Ctn.
0.45 Sq.m. / Ctn.

*Remark Pieces per Square Meter is calculated based on without joint installation
In case LAVA-206 and LAVA-406 are used together, each will require 38 Pcs. / Sq. M.



Backwoods : BW-134 / Color : Palm

Backwoods

Wood is one of the essential materials that have been with humanity. Its strength and the warm atmosphere of wood, bring it to one of the most popular construction material since the ancient time. The strength of wood does not last long due to its softness, low deep abrasion, difficult to maintenance, and changes the color makes its beauty does not last long Backwoods is homogeneous wooden ceramics tiles, not only screen the pattern on its surface and also acidic resistance. Backwoods has been fired in a high temperature 1,250 degree Celsius. Thus makes Backwoods strong, durable and suitable in all area of your home. Even in a heavy duty area such as garage and drive way, high traffic area such as foot path and building entrance, High humidity are such as border of swimming pool deck. Backwoods “Everlasting Beauty of Nature”



-  Interior wall installation
-  Exterior wall installation
-  Interior floor installation
-  Exterior floor installation
-  Staircase installation
-  Installation with joint
-  Installation without joint



Backwoods : BW-134 / Color : Mahogany

BW-134



105 mm. x 325 mm. x 14 mm.
 29 Pcs. / Sq.m.
 20 Pcs. / Ctn.
 0.69 Sq.m. / Ctn.

Remark Pieces per Square Meter is calculated based on installation with 3 mm joint

COLORS



Mahogany



Palm



Magnolia



Red Sea



Black Mountain

*ACTUAL COLORS MAY LOOK SLIGHTLY DIFFERENT DUE TO PRINTING



Design Pattern



Ombra : OB-206 **Extruded Tile** : F206 / Color : Bricky Brown

COLORS



Wine Red



Bricky Brown



Charcoal



White



Silver Grey





Ombra : OB-206 / Color : Wine Red



60 x 210 x 16 x 45 mm.
 79 Pcs. / Sq.m.
 24 Pcs. / Ctn.
 0.30 Sq.m. / Ctn.

Remark Pieces per Square Meter is calculated based on installation without joint

Ombra

A special design of wedge-shaped extruded tile that create a unique 3D stepped pattern which can combine with other extruded tile and old country series to add a different format that similar to no one to your home.



Interior wall installation



Exterior wall installation



Installation without joint



DEmark



GOOD DESIGN

THAILAND-JAPAN: DESIGN AWARD PARTNERSHIP

HOLO BLOCK



Holo Block : HB-131 / Color : Bricky Brown

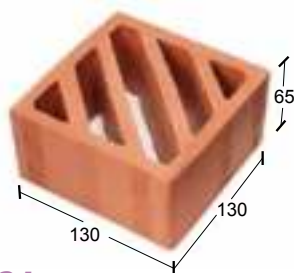

HB-131

130 mm. x 130 mm. x 65 mm.

60 Pcs./Sq.m.

16 Pcs./Ctn.

Remark Pieces per Square Meter is calculated based on installation with 1 cm. joint



Wine Red

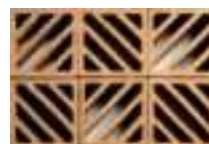

Bricky Brown

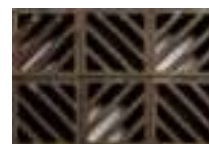

Charcoal

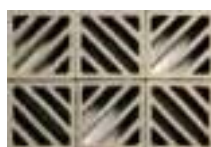

White



Silver Grey



Interior wall installation



Exterior wall installation



Installation with joint



7

Vento Series :VT-065 / Color :Wine Red



White



Silver Grey



Wine Red



Bricky Brown



Charcoal

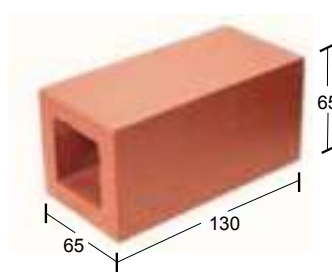

VT-065

65 mm. x 65 mm. x 130 mm.

170 Pcs./Sq.m.

32 Pcs./Ctn.

Remark Pieces per Square Meter is calculated based on installation with 1 cm. joint



*ACTUAL COLORS MAY LOOK SLIGHTLY DIFFERENT DUE TO PRINTING



Thermic : TM-201 / Color : Charcoal

THERMIC PATTERN



THAILAND-JAPAN: DESIGN AWARD PARTNERSHIP



TM-101 + F-101

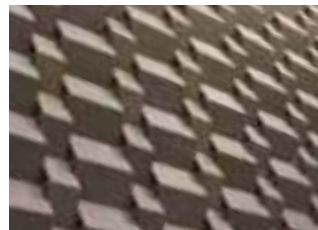

TM-201 + F-201



TM-201

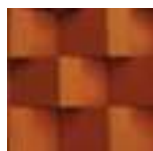

Wine Red

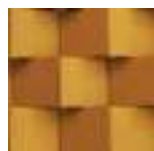

Bricky Brown

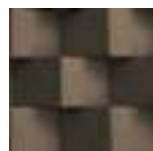

Charcoal



White

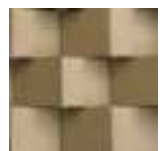

Silver Grey



Interior wall installation



Exterior wall installation



Installation without joint

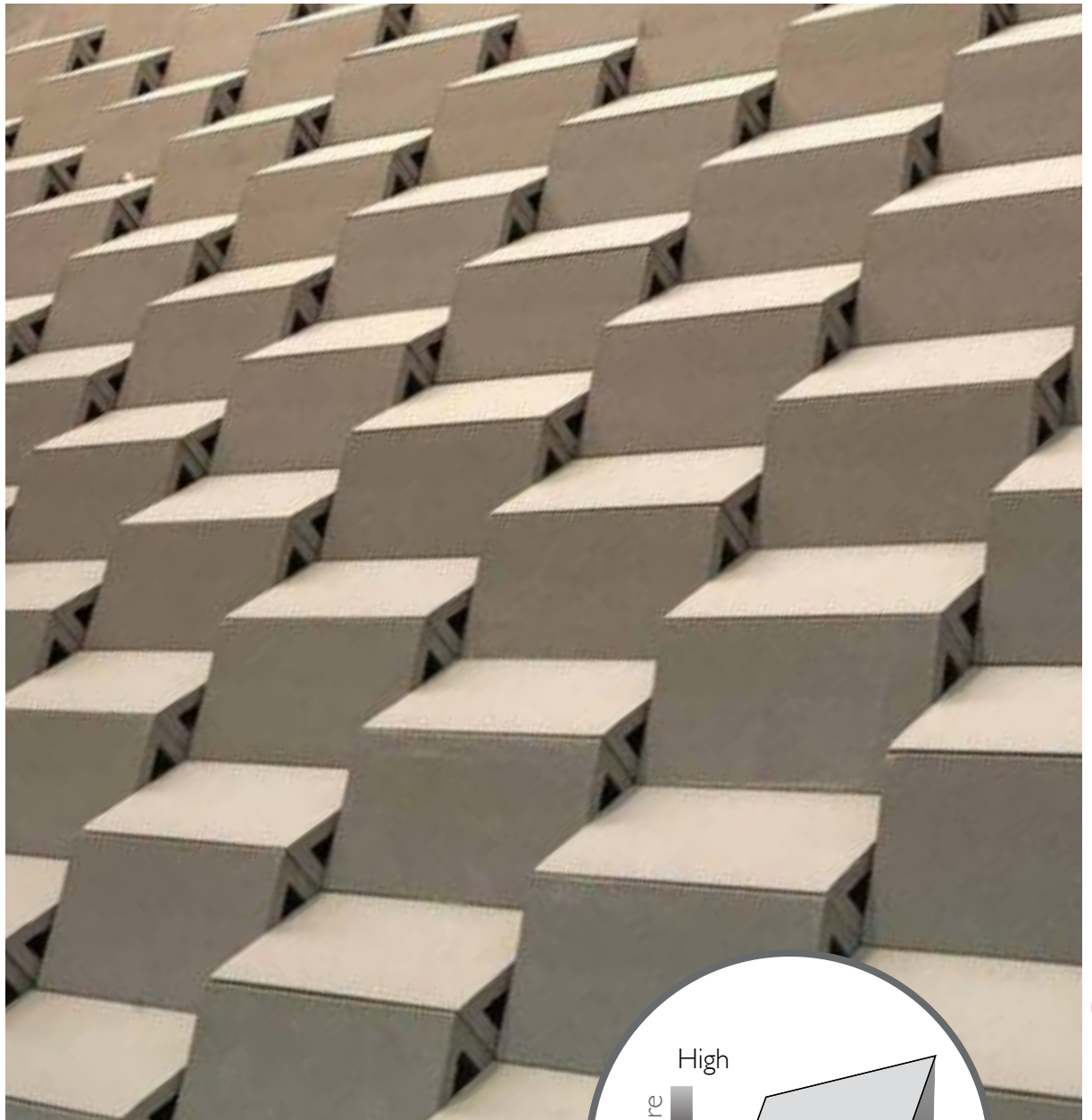

Thermic :TM-201 / Color : Silver Grey

Thermal insulation using natural mechanism
Thermodynamic system, heat from the sun will not be transferred to a building because the collected heat on the surface is cool down by natural air-flow in the middle.

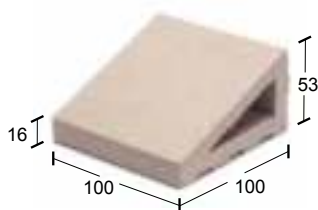
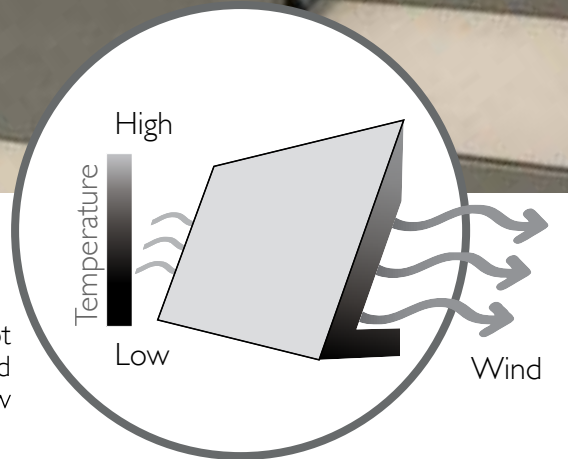

TM-101

100 mm. x 100 mm. x 53 mm.
100 Pcs./Sq.m.
36 Pcs./Ctn.

Remark Pieces per Square Meter is calculated based on installation without joint

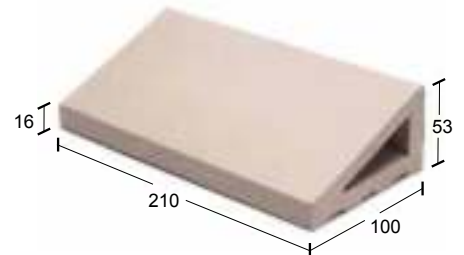

TM-201

210 mm. x 100 mm. x 53 mm.
48 Pcs./Sq.m.
18 Pcs./Ctn.

Remark Pieces per Square Meter is calculated based on installation without joint



Kenzei Plus : KZ PS-606 / Color : Yellow

Kenzei Plus

Was designed to alert the pedestrian who has sight problem to aware from impending danger such as level change, stop sign and change of direction. Kenzei Plus is the Homogeneous ceramic tile fired with high temperature at 1,250 °c. Resistant to chemical, thermal shock and low level of water absorption. (less than 1%)



Kenzei Plus : KZ PS-606 / Color : Yellow

GLAZED
CERAMIC TILES



Yellow

HOMOGENEOUS
CERAMIC TILES



Bright Yellow



Interior floor
installation



Exterior floor
installation



Staircase
installation



Installation
with joint



Installation
without joint



Kenzai Plus : KZ PS-606 , KZ GT-606 / Color : Yellow

WARNING TILE

DIRECTIONAL TILE

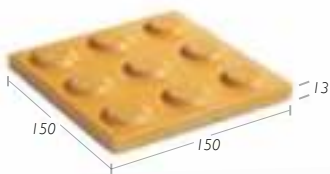

KZ PS-606
150 x 150 x 13 mm.
42 Pcs. / Sq.m.
20 Pcs. / Ctn.

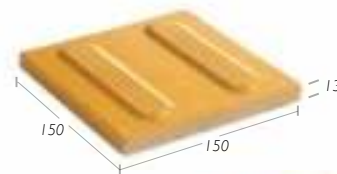

KZ GT-606
150 x 150 x 13 mm.
42 Pcs. / Sq.m.
20 Pcs. / Ctn.

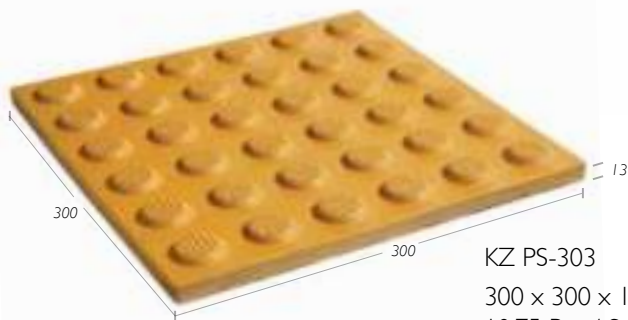

KZ PS-303
300 x 300 x 13 mm.
10.75 Pcs. / Sq.m.
4 Pcs. / Ctn.

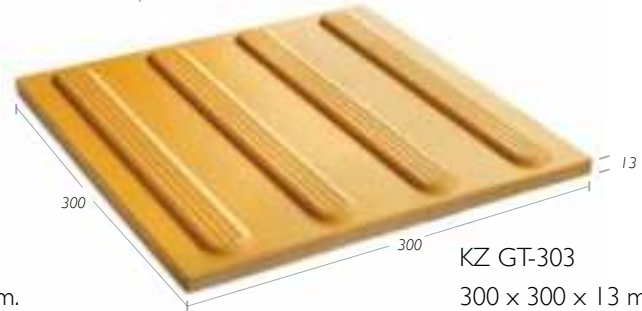

KZ GT-303
300 x 300 x 13 mm.
10.75 Pcs. / Sq.m.
4 Pcs. / Ctn.





Nova Tile : NOVA-30 / Color : White Champagne

8

Nova Tile

Is an homogeneous ceramic tile, suitable for exterior area, especially traffic area, carrying weight, durable to scratch, sunlight, acid, convenient to clean and R12 of slip resistance rate, can use for every situation including raining and safe for users



NOVA -30

300 x 300 x 15 mm.
10.75 Pcs. / Sq.m.
5 Pcs. / Ctn.

Amount of tiles are calculated by 1 cm. with joint installation

COLORS



Gypsy Tile

The swimming pool tile glazed and smooth surface with extraordinary pattern underneath. This creates a magnificent and classic look for swimming pool and exterior - interior wall and floor tile.

GY-101

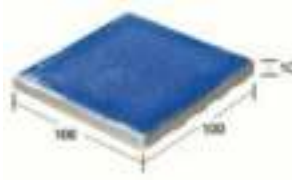

100 x 100 x 10 mm.
90 Pcs. / Sq.m.
90 Pcs. / Ctn.

GY-206

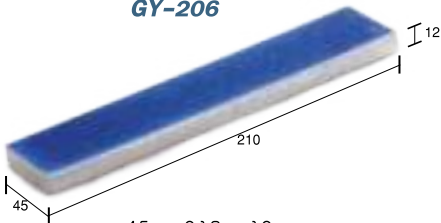

45 x 210 x 12 mm.
92 Pcs. / Sq.m.
92 Pcs. / Ctn.

Remark Pieces per Square Meter is calculated based on installation with 0.5 cm. joint



Gypsy Tile : GY-101 / Color : Hawaiian Blue 2

COLORS

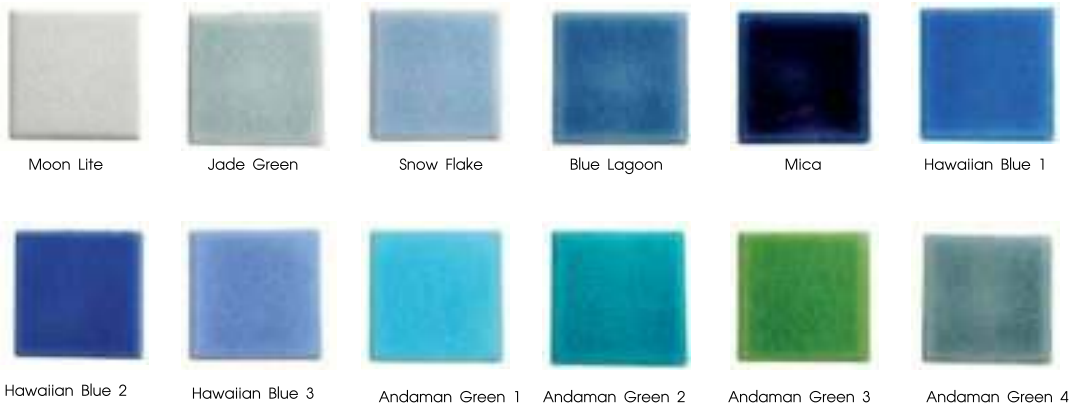

Interior wall installation



Exterior wall installation



Interior floor installation



Exterior floor installation



Installation with joint

*ACTUAL COLORS MAY LOOK SLIGHTLY DIFFERENT DUE TO PRINTING



Persia : PSF-101 | Color : Hawaiian Blue |

Persia

The swimming pool and exterior – interior wall and floor tile. The glazed surface with remarkable texture looks like natural stone and reflecting attractive dimension.

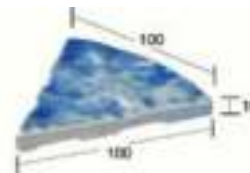

PST-100

100 x 100 x 10 mm.
60 Pcs. / Ctn.

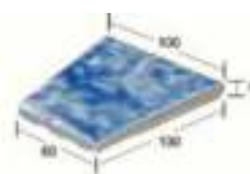

PSB-100

60 x 100 x 100 x 10 mm.
114 Pcs. / Sq.m.
70 Pcs. / Ctn.

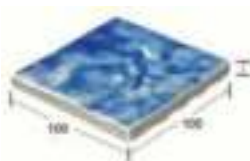

PSF-101

100 x 100 x 10 mm.
90 Pcs. / Sq.m.
90 Pcs. / Ctn.

Remark Pieces per Square Meter is calculated based on installation with 0.5 cm. joint

COLORS



Moon Life



Jade Green



Snow Flake



Blue Lagoon



Mica



Hawaiian Blue 1



Hawaiian Blue 2



Hawaiian Blue 3



Andaman Green 1



Andaman Green 2



Andaman Green 3



Andaman Green 4



Interior wall installation



Exterior wall installation



Interior floor installation



Exterior floor installation



Installation with joint

Quart Rounds

The swimming pool tile with corner. Easy cleaning. The shape prevent possible danger while swimming. It can be decorated in any area.



Gypsy Tile : GY-101 / Color : Andaman Green 2



A

GO-101

31 X 100 X 10 mm.
10 Pcs. / 1 m.



B

GV-101

17 X 100 X 10 mm.
10 Pcs. / 1 m.

Remark Pieces per Square Meter is calculated based on installation with 0.5 cm. joint

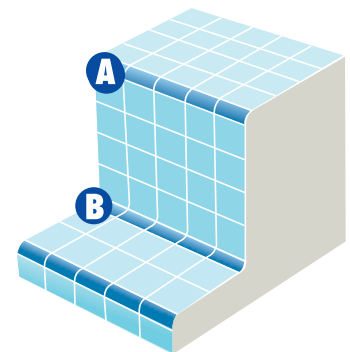

COLORS

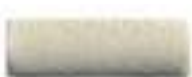

Moon Lite



Jade Green



Snow Flake



Blue Lagoon



Mica



Hawaiian Blue 1



Hawaiian Blue 2



Hawaiian Blue 3



Andaman Green 1



Andaman Green 2



Andaman Green 3



Andaman Green 4



Amazon Tile :AMA-101 / Color : Peacock

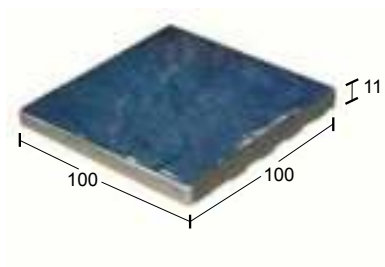

AMA-101

100 x 100 x 11 mm.

80 Pcs. / Sq.m.

90 Pcs. / Ctn.

Remark Pieces per Square Meter is calculated based on installation with 0.5 cm. joint

COLORS



Midnight Blue



Black Pepper



Peacock



Ocean Blue



Navy Blue



Spring Summer



Green Wave



Blue Bird



Blue River



Silver Blue



Taro



Snow Flake



Interior wall installation



Exterior wall installation



Interior floor installation



Exterior floor installation



Installation with joint



Quartz Stone : QS-101 / Color : Oklahoma

COLORS

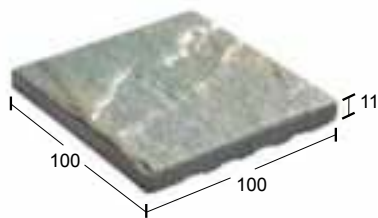

QS-101

100 x 100 x 11 mm.

80 Pcs. / Sq.m.

60 Pcs. / Ctn.

Remark Pieces per Square Meter is calculated based on installation with 0.5 cm. joint



Dakota



Idaho



Iowa



Ohio



Oklahoma



Montana



Arkansas



Atlanta



Interior wall installation



Exterior wall installation



Interior floor installation



Exterior floor installation



Installation with joint



Monalisa : MO-816 Sweet Cherry



Monalisa : MO-816 Franch Wine

Monalisa

The design for modern house with a unique style. The colorful picture will make your wall beautiful and far more attractive to a visitor. The picture on the tile match to dining room, kitchen, living room or relaxing corner. Monalisa tiles will make your house artistic, lively and energetic. The restaurant, ice cream shop, bakery shop, flower shop are also compatible. The pictures look real and reflect your passion. It is easy to clean up with soap.



Interior wall
installation



Installation
without joint



Franch Wine



Milky



Sweet Cherry



Italian Coffee



Spring Flower



Choc Sundae

MO-816

200 mm. x 400 mm. x 9 mm.

3 Pcs. / Set

3 Pcs. / Ctn.

10

K-BOND

Tile Adhesive

“High quality Tile adhesive for every size, low water absorption, Granito, Natural stone, interior & exterior including floor and wall”

Characteristics

Tile adhesive for every tile size (including over 50x50 cm.) Marble Granit Porcelain, low water absorption tile for floor and wall, interior and exterior building. Convenient for installation high bonding with polymer and cellulous fiber from Germany, no slip while installing, longer open time at 30 minutes, longer tile adjustment

Materials

Cement Portland type 1 TIS.15-2547 limestone and silica with high grade, dry chemical from Europe

Usage Quantity : 1 tile adhesive bag (20 kg.) install around 5 - 6 sq.m. thickness 3-5 mm.

Contain Quantity : 20 kg./bag

Types K-Bond Green Tile Adhesive
K-Bond Red Tile Adhesive for high bonding installation

Technical Data

Testing	K-Bond	Requirement
Water mixing ratio	20 Kg / 4.5-5 L	
Anti Sagging Property (EN1308)	<0.5mm.	<0.5mm.
Open time	0.75 N/mm ²	20 minutes
Setting Time		
Initial set	6 hours	>6 hours
Final set	9 hours	> 9 hours
Bucket Life	1-2 hours	-
Water Retentivity	99.40%	
28 Day Compressive Strength	= 17.4 N/mm ²	
28 Day Flexural Strength	= 5.5 N/mm ²	
Tensile Adhesion Strength		
28 Day Standard Condition	1.40 N/mm ²	>0.5 N/mm ²
7 Day Standard Condition + 21 Day Water Immersion	1.21 N/mm ²	>0.5 N/mm ²
The state heat treating 14d S.C+ 14d 70°C+ 1d S.C.	1.21 N/mm ²	>0.5 N/mm ²
Shear Charge (ANSI 118.1)		
1 Day Standard Condition	1.33 N/mm ²	
7 Day Standard Condition	3.45 N/mm ²	
7d Day Standard Condition + 7 Day Water Immersion	1.81 N/mm ²	



**K-BOND
Green**



**K-BOND
Red**

K-BOND Quality Comparison		
Highlight	K-BOND Green	K-BOND RED
Tile Adhesive K-BOND	General Installation	Granito or Swimming Pool
Contain Size	20 kg.	20 kg.
Tile Diversion		
Low Water Absorption : Extruded and Ceramic	✓	✓
Low Water Absorption : Granito and Porcelain	✓	✓
Non-Water Absorption : Mosaic Glass		
Natural Stone:Marble Granit Cladding	Floor / Exterior	Floor / Exterior
Tile Size		
Small 20x20 cm - 30x30 cm	✓	✓
Medium 40x40 cm – 45x45 cm – 30x60 cm	✓	✓
Big 60x60 cm – 60x80 cm	✓	✓
Sizable 60x120 cm 100x300 cm 160x320 cm.		Floor
Floor Type		
Cement	✓	✓
Polish Cement	✓	✓
Installation Replacement	✓	✓
Lightweight Concrete Fiber Cement	✓	✓
Usage Area		
Office Lobby Living Bed Room/Interior Wall	✓	✓
Bathroom Washing Area Kitchen	✓	✓
Exterior Floor	✓	✓
Exterior Wall	Not Over 3 m.	✓
Swimming Pool Sauna Spa		✓
Parking Lot		✓
Industry Floor		✓
Shopping Mall		✓

K-Bond Sanded Grout



K-BOND

Sanded Grout

Grout mix with K-Bond Sand

Polymer mixing for stronger bonding, no shrinking, no broken including mold and fungus. Suitable for grouting 3-13 mm. usage: interior and exterior floor and wall, fountain, waterfall and Swimming Pool

Characteristics

- Convenient for usage, mix with water at portion
- Mix with polymer for stronger bonding and protecting fungus

Suggestions

- Grouting tile or sanitary at 3-13 mm.
- For interior and exterior floor and wall of building
- Suitable for residence, rest room, counter and general public
- Water area such as water, fountain, water fall and well

Tile of tile for K-Bond Sanded Grout usage

- Coated Tile, Semi-Coated Tile and Non-Coated Tile
- Mosaic Natural Stone and Concrete Tile
- Brick and Cement Block
- Terazzo Tile
- Natural Stone

Ingredients

K-Bond Grout is mixed with sand compose of cement, porcelain, fine sand and chemical for fungus protection and for stronger bonding

Benefits

- The grout is beautiful, strong, durable, not mold.
- The grout groove does not shrink, does not crack,

sesame, not sifted into dust.

Limitation

- Should not use in 10°C and over 38°C
- Should be careful for scratch on tile surface and installation test on small area

Containing

- 20 KG. White / Gray

Portion

1 liter of water with 6 KG. of K-Bond Sanded Grout

Technical Data

1. 28 Day Compressive strength	15-21 N/mm ²
2. 28 Day Flexural strength	4.5 N/mm ²
3. Water retention	95 - 98%
4. Initial setting time Final setting time	3 - 4 Hrs. 6 - 8 Hrs
5. Linear Shrinkage 40x40x160 mm.	≤ 3 mm/m
6. water absorption at 30 min. water absorption at 240 min.	≤ 5 g ≤ 10 g

K-BOND

Tile Adhesive

Testing	K-Bond Red	K-Bond Green	Requirement
Water mixing ratio	20 Kg / 4.5-5 L	20 Kg / 4.5-5 L	
Anti Sagging Property EN1308	<0.5mm.	<0.5mm.	≤0.5mm.
Open time	0.75 N/mm ²	0.50 N/mm ²	20 minutes
Setting Time			
Initial set	6 hours	6 hours	≥6 hours
Final set	9 hours	9 hours	≥ 9 hours
Bucket Life	1-2 hours	1 hours	1 hours
Water Retentivity	99.40%	99.30%	
28 Day Compressive Strength	= 17.4 N/mm ²	= 23.0 N/mm ²	
28 Day Flexural Strength	= 5.50 N/mm ²	= 5.57 N/mm ²	
Tensile Adhesion Strength			
- 28 Day Standard Condition	1.40 N/mm ²	1.13 N/mm ²	≥0.5 N/mm ²
- 7 Day Standard Condition + 21 Day Water Immersion	1.21 N/mm ²	0.84 N/mm ²	≥0.5 N/mm ²
- สภาวะถูกอบด้วยความร้อน 14d S.C+ 14d 70oC+ 1d S.C.	1.21 N/mm ²	0.54 N/mm ²	≥0.5 N/mm ²
ค่าแรงฉีก (ANSI 118.1)			
1 Day Standard Condition	1.33 N/mm ²	1.32 N/mm ²	
1 Day Standard Condition	3.45 N/mm ²	2.54 N/mm ²	
7d S.C. + 7d Water Immersion	1.81 N/mm ²	1.05 N/mm ²	

Tips

- Kbond tile adhesive can be used for low and high water absorption installation, so it is unnecessary to soak in the water
- Every 5 m. installation, need to do expansion joint and grouting with sealant polyurethane for tile expansion preventing disintegration from concrete heat
- After installation should leave 24-48 hours for water volatile then grouting and joint will be smooth
- Should use Kbond tile adhesive to together with Kbond grout for exterior area and swimming pool to reduce stain and black mold

Methods for Kbond tile adhesive and grouting (Floor)



1. Tile adhesive with water portion adhesive:water 4:1



2. Pour the installing area for high level bonding



3. Apply adhesive at the back of tile

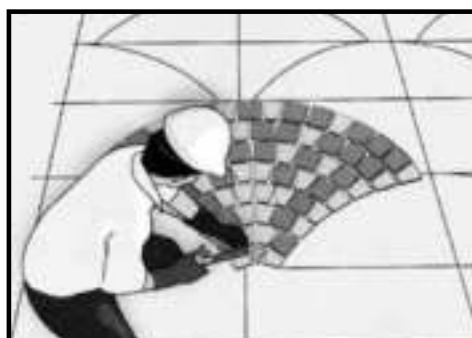

4. Install and adjust tile

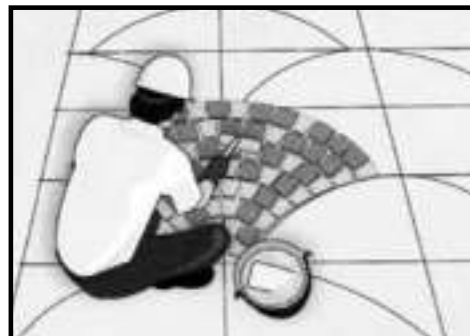

5. Brush and plate water adhesive on tile surface to clean adhesive



6. Use sponge with water to clean adhesive and leave at least 1 day then grouting



7. Pour water on the tile and use wooden trowel with Kbond Sanded Grout for grouting

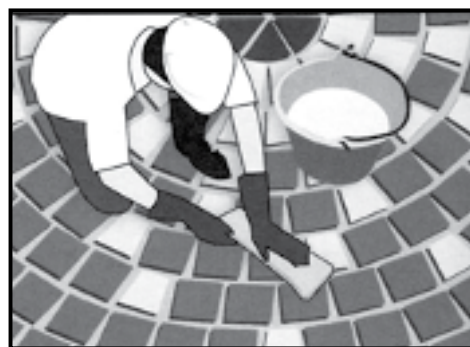

8. Use sponge with water to clean tile surface and leave 1 day

Methods of Kbond Tile adhesive and Grout usage (Wall)



1. Tile adhesive with water portion adhesive:water 4:1



2. Apply adhesive at the back of tile



3. Continue installing and catch the line for certain level



4. Brush and plate water adhesive on tile surface to clean adhesive



5. Use sponge with water to clean adhesive and leave at least 1 day



6. Pour water on the tile and use wooden trowel with Kbond Sanded Grout for grouting



7. Use sponge with water to clean tile surface and leave 1 day

Methods of Kbond Tile adhesive and Grout usage (Swimming Pool)

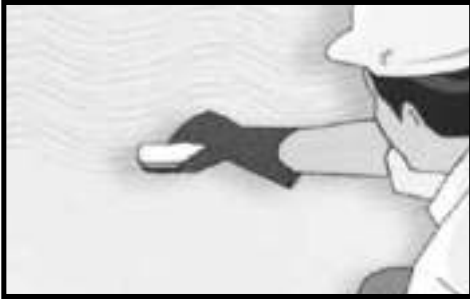

1. Adjust floor level before installation, use bonding agent after that use Kbond Red and slit to advance bonding and leave for 5-7 days

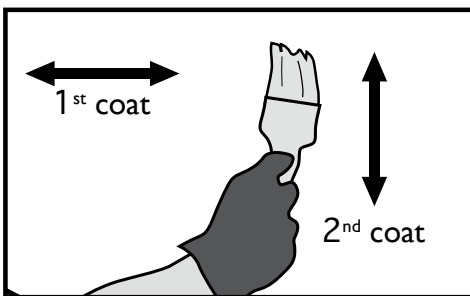

2. Use liner cement base (flexible type) 2 times 6 hour per round leave 3-5 days for liner settling and watering test 4 days and wait for dry 1-2 days

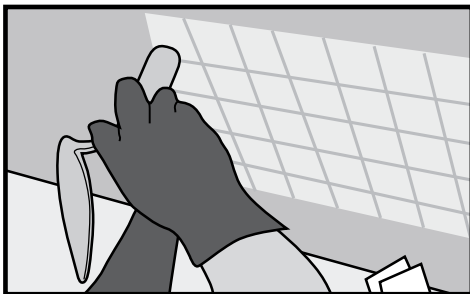

3. Draw the line and install with Kbond Red

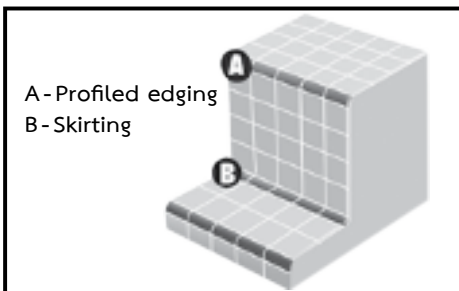

4. For corner, use Coated Quart Round for beauty and safety of users

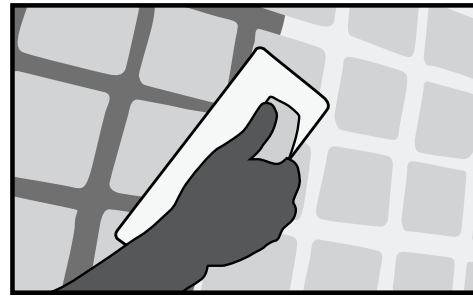

5. After installation, leave at least 1 day then grouting with Kbond Grout, After grouting cover with canvas 3 days to prevent shrinking

Kenzai Tile Cleaning Methods

2 Methods as follows :

Method 1 *Equipment*

1. Sprinkler

Cleaning method

1. Use sprinkler to clean the stain

Method 2 *Equipment*

1. Rubber Gloves
2. Hygiene or Detergent
3. Plastic Brush

Cleaning method

1. Spray and clean with hygiene or detergent brush with plastic brush
2. use water to clean hygiene

**can use brushing machine or nylon brush in the public for spontaneous and convenient cleaning*

A LITTLE **BIG** DIFFERENCE

Create new atmosphere to your house that match with your style

Before



After

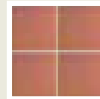

FLOOR
FF-130
Roza



WALL
LAVA-406 + LAVA-206
Polar White

Before



After

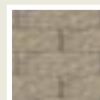

WALL
RK-508
Autumn



WALL
TU-145
Cookie and Cream

Here some consideration about the characteristics of ceramic products depending from the production conditions.

One of the most important property that a tile, used for flooring, is the resistance to the aggression of:

- 1) LOAD (STAIC AND DYNAMIC)
- 2) ROLLING ACTION
- 3) IMPACT

All three of those “aggressive agents” can be contrasted mainly to a proper mechanical strength of the tile.

The International Standards EN14411 envisages two parameters for the evaluation of the mechanical strength:

1 BREAKING STRENGTH

His value corresponds to the effective load applied on a tile that lead to breakage, when the tile is sustained by two supports. The formula that correlates the load values to the size of the tile and the distance of the supports is:

$$S = F \frac{L}{b}$$

The measuring unit of S is Newton (9.8 Newton = 1 kg.)

2 BENDING STRENGTH (modulus of rupture).

His value provides the approximate mechanical strength of the ceramic tile independently of tile thickness; practically this value identifies the intrinsic value of the me chanical strength of the material. The formula giving the value of the modulus of rupture is:

$$\sigma = \frac{3FL}{2bh^2}$$

The measuring unit of σ is Newton/mm²

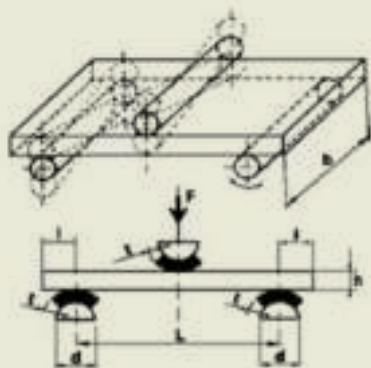

Where:

F = is the breaking load, or the force (express in Newton) necessary to apply that cause the test piece to break.

L = is the distance (expressed in mm) between the two supports that carry the tile piece

b = is the width (expressed in mm) of the tile test piece

h = is the minimum thickness of the tile test piece measured in the breaking's line.

The modulus of rupture is an intrinsic tile characteristic. It depends on the strength of the molecular bonds in the ceramic body, which in their turn are a function of the type of ceramic compounds which have developed during firing.

What is finally important in a tile used in a flooring, especially designed to use in difficult conditions (external public pavements or in very busy areas such as supermarkets)? Is the high Modulus of Rupture or the real high load that the tile can carry without breakage, once it is used in the flooring?

It is evident that the final customer will appreciate only the high load that the tile can support without breakage!

Suppose that the tiles are in the same conditions, with a bad installation, which has created only some points of support under their surface. We say that the tiles have an empty space and that the distance between the support points is 200mm. This is an example of very bad installation if it occurs in the reality, but it's just to give a clear idea of what we want to prove.

It is as well evident that it is in relation with

$$S:\sigma = \frac{3S}{2h^2}$$

One of the tiles (which we call A) has a modulus of rupture to 20N and a thickness of 9mm. The other tile (which we call B) has a higher modulus of rupture of 100% compared to A, that is to 40N and a thickness of 6mm, lower then to only 3 mm of 9mm, that is 33.3% less than A.

What do you expect would be the one that supports a greater load before breaking down?

TILE A

$$S:20 = \frac{3S}{2(9)^2}$$

$$S: 1080$$

TILE B

$$S:40 = \frac{3S}{2(6)^2}$$

$$S: 960$$

From the formulas above mentioned is easy to determine that the parameter that has the most effective role in the real load (*F*) that the tile can support without breakage is the thickness. In fact, to compensate just the 33% of reduced thickness, it is not enough to have a MOR 100% higher! The optimal choice selecting a floor tile, is to select product with good MOR, but paying very much attention to the rights thickness that will allows to face property to load that can occur on the floor where the tile will be utilized.

(Dr. Elio Gerardi , Ceramic Material Specialist ; Italy ,2017)

Durability of Ceramic Tiles

$$\sigma = \frac{3S}{2h^2}$$

σ = Bending Strength (Modulus of Rupture or MOR) (Newton/ mm^2)

S = Breaking Strength (Newton)

The measuring unit of S is Newton (9.8 Newton = 1 kg)

h = Is the minimum thickness of the line test piece measured in the breaking's line

Solution

Tile A MOR = 20 N/ mm^2
thickness 9 mm.

$$\text{Substitute : } 20 = \frac{3S}{2(9)^2}$$

$$S = 1,080 \text{ N.}$$

$$\text{Convert to KG : } \frac{1,080}{9.8} = 110 \text{ KGs.}$$

Tile B MOR = 40 N/ mm^2
thickness 6 mm.

$$\text{Substitute : } 40 = \frac{3S}{2(6)^2}$$

$$S = 960 \text{ N.}$$

$$\text{Convert to KG : } \frac{960}{9.8} = 97.95 \text{ kg}$$

The conclusion, tile A has a lower MOR test result, but it is able to gain more weight than tile B, even though tile B has a higher MOR test. From this formula Show that the thicker tile will affect the weight better:

Kenzai tiles MOR = 31 N / mm^2 thickness 13 mm.

$$\text{Substitute: } 31 = \frac{3S}{2(13)^2}$$

$$S = 3,492.66 \text{ N.}$$

$$\text{Convert to KG : } \frac{3,492.66}{9.8} = 356.39 \text{ KGs/mm}^2$$

The exterior decoration tiles have to be heavy duty tiles condition. The tiles should have high impact strength and should be capable to withstand wide range of toughness and heavy load. In case high pressure loading and high value of Breaking strength and Modulus of Rupture are very important to consider when the tile is used under heavy traffic condition.

Example

The result of using a low MOR tile or too thin tile.



Warning

1. Some manufacturers may provide false information on the test report; such as the object that is tested in the laboratory and the actual production's product is different properties' result. To assure the quality of the products that have been purchased, retesting the property of product in the certified laboratory is recommended. The actual result of the product that purchased in the project will be more precise. (Dr. Elio Gerardi , *Ceramic Material Specialist ; Italy ,2017*)

2. Water absorption should not be too low because it will affect to the floor and wall tiles installation. And it will absorb too little tile adhesive, which may be peeled off easily.

3. Some tiles that have low water absorption are from the waterproof coating on the front surface only. To find the actual water absorption of the tiles, it should be tested as removing the coated surface off, thus will result the actual percentage of water absorption.



CENTRO CERAMICO
CENTRO DI RICERCA E SPERIMENTAZIONE
PER L'INDUSTRIA CERAMICA Bologna, Italy
Concerning Ceramic Tiles According to EN67

ASTM STANDARD

In accordance with American National Standard Institute



FROST RESISTANCE
(EN 1441)



THERMAL SHOCK
RESISTANCE
(EN 104)

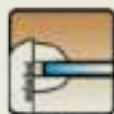

THICKNESS
(ASTM C 405)



FACIAL DIMENSION
(ASTM C 499)



IMPACT RESISTANCE
(ASTM C 368 Procedure)



BREAKING STRENGTH
(ASTM C-648)
Average: 432 lbs.



STATIC COEFFICIENT
OF FRICTION
(ASTM C 1028-89)
Average: 0.87 when wet



tel. 2508-2555



BOND STRENGTH
(ASTM C 487)
Average: 82 PSI



ABRASIVE HARDNESS
(ASTM C-501)
Index of 58



WATER ABSORPTION
(ASTM C 373)
Less than 1.84%



MODULUS OF RUPTURE
(ASTM C 674 Modified)
Average: 7,480 PSI



CHEMICAL RESISTANCE
(ASTM C 660)
ACID: 10% HCL - Unaffected
ALKALI: 10% KOH - Unaffected

Product Specification			Bla * Porcelain	B1b * Homogenous	EX GF-202 Kenzi Granito Tile
Properties	Tests	Unit	Criteria	Criteria	Test results
Length & Width	From the work size.	Percent	± 0.6	± 0.6	± 0.44
	From the average size of the 10 tiles	Percent	± 0.5	± 0.5	± 0.09
Thickness	From the work size.	Percent	± 5	± 5	± 4.81
Straightness of Sides	From the work size.	Percent	± 0.5	± 0.5	± 0.14
Rectangularity	From the work size.	Percent	± 0.6	± 0.6	± 0.38
Surface Flatness the max deviation from flatness					
Center curvature		Percent	± 0.5	± 0.5	± 0.4
Edge curvature		Percent	± 0.5	± 0.5	± 0.47
Wryness		Percent	± 0.5	± 0.5	± 0.27
Water Absorption	Individual	Percent	≤ 0.6	≤ 3.3	0.47
	Average	Percent	≤ 0.5	0.5 ≤ E ≤ 3	0.43
Breaking Strength	Individual	N	≥ 1300	≥ 1100	1928.9
Modulus of Rupture	Individual	N / mm ²	≥ 32	≥ 27	28.9
	Average	N / mm ²	≥ 35	≥ 30	30.08
Abrasion Resistance		mm ³	≤ 175	≤ 175	98
Resistance to chemicals					
Low concentration of acids and alkalis			Manufacturer to state classification	Manufacturer to state classification	ULA
Household chemicals and swimming pool salts			Minimum class UB	Minimum class UB	UA

* Reference from TIS.2398 and ISO-10545

THE ISSUE OF NATURAL TILES

Exposed aggregate finish wall

Has deep gap which absorbs dirt and stains easily including water and moisture. This causes mould and fungus. For this type the surface usually peels off easily.



Brick wall

Is made of low temperature fired brick, making it volatile and highly adsorbs water. This creates fungus and moss.



Sandstone

Is a natural stone that has many tiny holes absorbing high level water. This causes fungus and moss. Kenzai tiles have low water absorption which does not have the same problem as natural tile and have passed widely accepted standard both from U.S.A and Europe.



Plaster Wall

Will be easy to have stain, especially black spots, fungus. The problem of skin cracking when the time passes. Using Kenzai tiles will make the wall durable to stains, specially the wall will look better and more beautiful.



Cemented coated wall

Will have stains even only a little amount of time passes by and crack will also appear. Using Kenzai tile makes the wall more durable, stainless and more attractive.



Painted wall

Will have stains in a short period of time, the color will fade resulting in more investment in renovation. Unlike using Kenzai tile for outdoor decorations, which have been fired at high temperature resulting in higher usage life.



Material

Used for wall must pass the accepted standard quality test because if the materials fail the test, problems are likely to arise such as stains, cracks, volatilities etc. causing more maintenance cost in the future.



Wall tiles adhesion

In some materials is low adhesion especially outdoors that must consider about exposed from sunlight and rain for a long time.



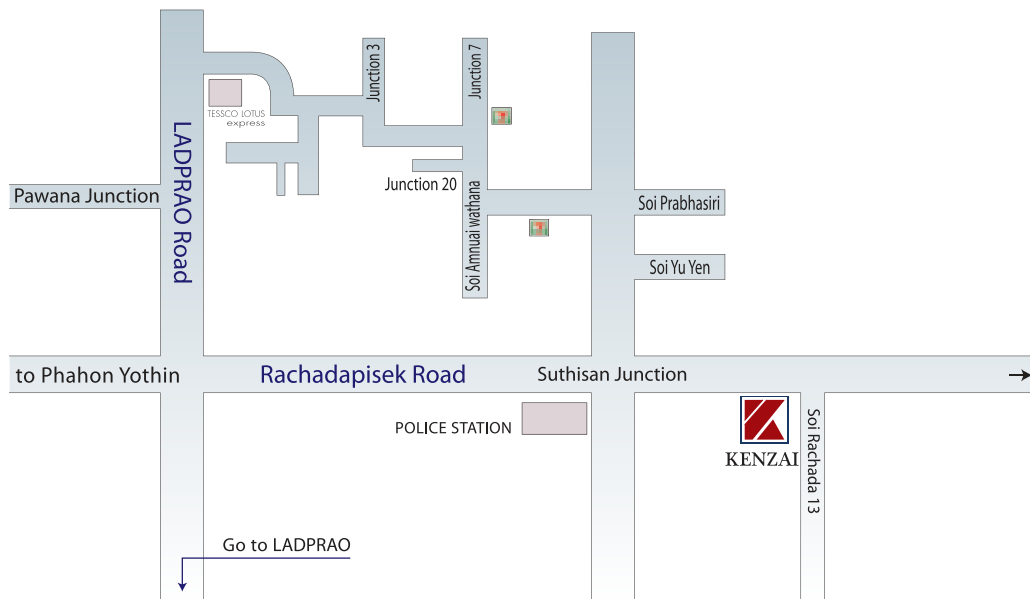

KENZAI CERAMIC CO., LTD.

169/94-97 Ratchadapisek Rd., Ratchadapisek, Dindaeng, Bangkok 10400 THAILAND
 Tel. : +662 692 5080 to 90 Fax. : +662 692 5091
 Email : kenzai@kenzai.co.th Website : www.kenzai.co.th



www.kenzai.co.th



kenzaiceramics



kenzaiceramics



kenzaiceramics



@kenzai