

## PASSIVE INFRARED and MICROWAVE COMBINATION DETECTOR

# CE0560!

With PET IMMUNITY

With PET IMMUNITY &amp; TAMPER

# MX-40QZ MX-50QZ MX-50T

# MX-40PI

# MX-40PT

### ■ FEATURES

- 40ft.x40ft.(12m x 12m) Wide Angle [MX-40 Series]
- 50ft.x50ft.(15m x 15m) Wide Angle [MX-50 Series]
- QUAD Zone Logic
- Patented Multi-focus Lens
- Improved Sealed Optics
- Temperature Compensation Logic
- Pet Immunity [MX-40PI/PT Only]

(See Section 5 for Pet Immunity)

Model MX-40PI/50T are UL Listed models.

### ■ EASY INSTALLATION

- Easy Wiring Knockout
- Wiring Guide
- Spare Terminal [MX-40QZ/50QZ/50T/40PT Only]
- Tamper Terminal [MX-40QZ/50QZ/50T/40PT Only]
- D.L. Terminal [MX-40QZ(BE)/50QZ(BE) Only]
- Wide Wiring Space

### ■ FUNCTION

- Selectable Pulse Count(2 or 4)
- LED ON/OFF
- Tamper Switch [MX-40QZ/50QZ/50T/40PT Only]
- Microwave Range Selector(LONG or SHORT)

### ■ OPTION

- FA-3 Wall & Ceiling Mount Bracket  
(Horizontally ±45° & Vertically 0° to -15°)

## 1. INSTALLATION HINTS



Avoid direct sunlight.

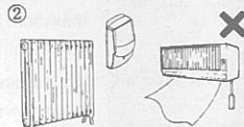

Avoid mounting detector where movement of Fans or Air Conditioning can be detected.



Avoid vapor or high humidity that can cause condensation.

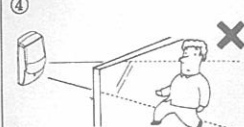

Avoid Curtain, Screen, etc. blocking detection area.

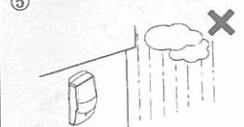

Do not install outdoors.

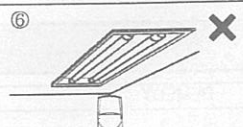

Do not install unit near fluorescent lights.

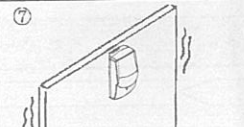

Do not mount in unstable location where vibration or shock may affect the detector.

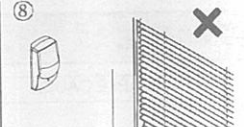

Do not aim detection area towards equipment which continually moves in the detection area (i.e. curtain, blinds).

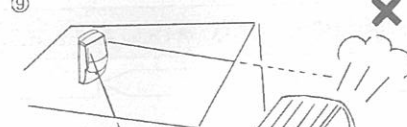

Do not aim towards outside areas where there is frequent movement.

## 2. DESCRIPTION, OPERATION and DIMENSIONS

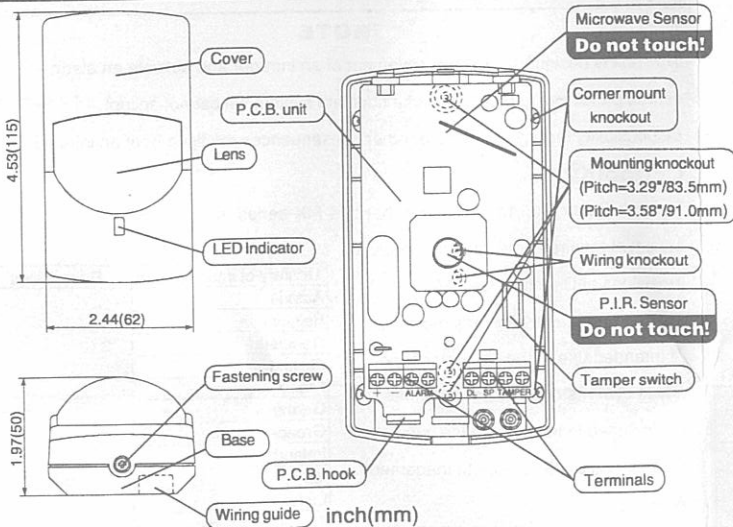

## 3. DETECTION AREA

### WIDE ANGLE

#### ■ TOP VIEW

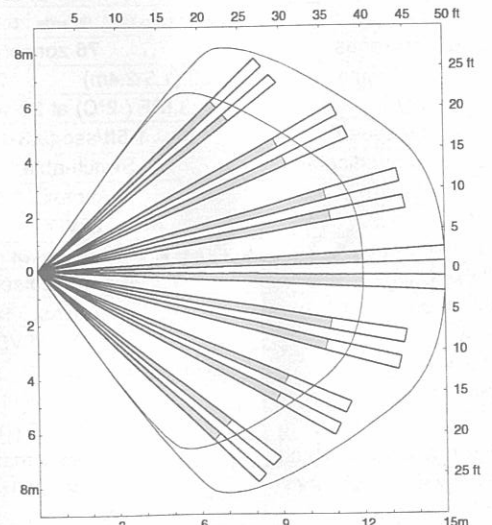

#### ■ SIDE VIEW

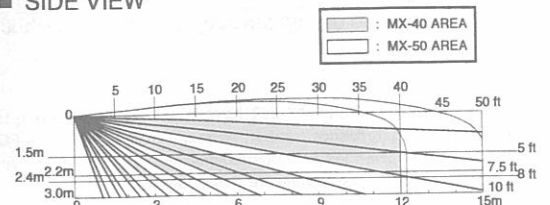

#### ■ LED ON/OFF

Use the pin switch for LED ON/OFF.

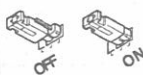

#### ■ PULSE COUNT

Use the pin switch for Pulse Count Selection (2 or 4).



#### ■ EASY WIRING KNOCKOUTS

Press firmly with a screwdriver to open. Enlarge the hole according to size of wire.



#### ■ MICROWAVE RANGE

Select RANGE SELECTOR according to the room size. (SHORT or LONG)



#### ■ D.L. TERMINAL (MX-40QZ(BE), MX-50QZ(BE) Only)

LED can be enabled or disabled remotely from control panel by D.L. terminal. Place jumper pin switch in OFF position.

LED Enabled	Connect D.L. terminal to common ground (with detector).
LED Disabled	No ground to D.L. terminal (open circuit).

#### MX-40 Series

Select RANGE SELECTOR "SHORT" when it's used with 24ft (7m) square and Smaller room.

#### MX-50 Series

Select RANGE SELECTOR "SHORT" when it's used with 34ft (10m) square and Smaller room.

## 4. INSTALLATION

- Loosen fastening screw and remove cover.
- Release hook at bottom of P.C.B. unit. Remove P.C.B. unit from base.
- Route wires through knockouts along the wiring guide on the rear side of base. Mount base with supplied screws. When small animal immunity is required, refer to Section 5. When using a bracket, check matching knockout position before opening mounting hole.
- Wire according to Section 6.

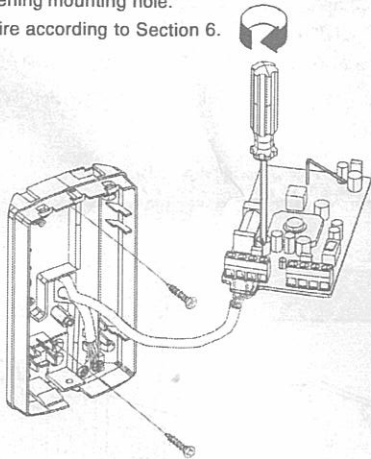

- Fix P.C.B. unit into base. Supply power. Allow 1 min. to warm up.
- Conduct walktest and make adjustments. (Section 2) Fit cover using fastening screw.

## 5. PET IMMUNITY (MX-40PI/40PT Only)

- Pet Immunity is most effective on the following sized animals: Rodents = 0 to 4 inches high  
Cats and small to medium sized dogs = 0 to 16 inches high at normal room temperature.
- Installation Instructions
  - Mount between 7 and 8 ft. (For better immunity, especially for medium sized dogs, mount as close to 8ft. as possible.)
  - Do not angle detector towards the ground or use the angle bracket. Mount flat on the wall or in the corner.
  - For best pet immunity, limit the detectors field of view to 30 ft. maximum in any direction.
  - For rodents  
If any shelves within 15 ft. of the detector have a height that comes within 2.5 ft. below the mounting height of the detector and rodents can access these areas, pet immunity will be reduced. Please select mounting location of detectors carefully to avoid this situation.
  - For cats and dogs (16 inches in height or less at normal room temperature) When a dog jumps up on desks, the detector may detect it. Adjust detection area to avoid such places.
  - For cats  
If there are cats, any shelves in the detection area will reduce pet immunity.
  - Pulse Count 4 is not required for Pet Immunity applications. Use 4 pulse only in harsh environment.

\*The Pet Immunity Function has not been evaluated by UL since there are not established UL requirements for pet immunity.

## 6. WIRING

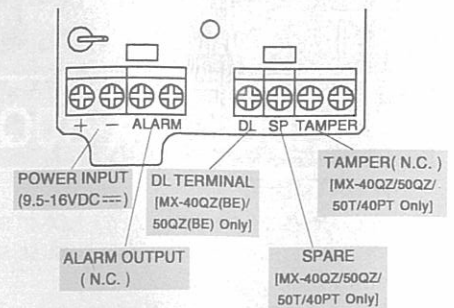

Power wires should not exceed the following lengths.

WIRE GAUGE	12VDC ---	14VDC ---
AWG 22 (0.33mm <sup>2</sup> )	1070' (320m)	2140' (650m)
AWG 20 (0.52mm <sup>2</sup> )	1700' (510m)	3400' (1020m)
AWG 18 (0.83mm <sup>2</sup> )	2700' (820m)	5300' (1600m)

When using two or more units on one wire, the maximum length is obtained by dividing the maximum wire length listed above by the number of units used.

\*UL requires MX-40PI, 50T to be connected to a UL listed power supply capable of providing a nominal input of 12VDC, 20mA(max.) --- (at 12VDC ---) and battery standby time of 4 hours.

\*The equipment shall be installed in accordance with the National Electrical Code, NFPA 70.

## 7. TROUBLE SHOOTING AND MAINTENANCE

PROBLEM	PROBABLE CAUSE	REMEDY
LED does not light.	Incorrect power supply voltage. (disconnection, low voltage) Incorrect detection area. LED switch is OFF.	Correct the voltage supply to 9.5-16VDC ---. See Section 3. Turn on the Switch. (See Section 2)
LED lights even though no person is within area.	Moving object within area: (curtain, wall hanging, etc.) Rapid temperature changes within area. (heater, air-conditioner, etc.)	Remove object from detection area, or change location of detector. Remove the source from area, or change location of detector.
LED lights but signal is not sent.	Relay contact is stuck or damaged due to overloading. Faulty wiring.	Check load of output. The unit needs repair or replacement. Wire correctly.

## 8. SPECIFICATIONS

MODEL	MX-40QZ/PI/PT	MX-50QZ/50T
Detection method	Passive Infrared and Microwave	
Coverage	40ftx40ft(12m x 12m) 85° wide	50ftx50ft(15m x 15m) 85° wide
Detection zones	78 zones(PIR)	
Mounting Height	5-8ft (1.5-2.4m)	7.5-10ft (2.2-3.0m)
Sensitivity	3.6°F ( 2°C) at 2ft/sec (0.6m/sec)	
Detection speed	1-5ft/sec (0.3-1.5m/sec)	
LED Alarm Indicator	Switch-able ON/OFF	
Alarm period	Approx. 2.5 sec	
Alarm output	N.C., 28VDC --- 0.2A max.	
Tamper switch	N.C., Open when cover is removed. (N.C., 28VDC --- 0.1A max.)	
Pulse Count	Approx. 20 sec 2 or 4	
Warm up period	Approx. 1 min	
Power input	9.5-16VDC ---	
Current draw	18mA (max.) at 12VDC ---	20mA (max.) at 12VDC ---
Weight	3.9 oz (110g)	
Operating temperature	-14°F - +131°F (-10 - +55°C)	
Environmental humidity	95% max.	
Microwave Frequency	2.45GHz	
RF interference	No Alarm 20V/m	
D.L. Terminal	See Section 2	

\*Specifications and design are subject to change without prior notice.

### NOTE

This unit is designed to detect movement of an intruder and activate an alarm control panel. Being only a part of a complete system, we cannot accept responsibility for any damages or other consequences resulting from an intrusion.

### CE0560!

Hereby, Optex Co., Ltd. declares that this MX series is in compliance with the essential requirements and other relevant

provisions of Directive 1999/5/EC.

The following table indicates the areas of intended use of the equipment and any known restrictions. For countries not included in this list, please consult the responsible Spectrum Management Agency.

Country of intended use	Restrictions
Austria	2.450GHz
Belgium	
Denmark	
Finland	
France	
Germany	
Greece	
Ireland	
Italy	
Luxembourg	
The Netherlands	
Spain	
Sweden	
United Kingdom	
Other non EU: Iceland	
Norway	
Switzerland	



OPTEX CO., LTD. (JAPAN)  
(ISO 9001 Certified)(ISO 14001 Certified)  
5-8-12 Oigasa Ohta-ku Shiga 533-0101 JAPAN  
TEL +81-77-579-8570 FAX +81-77-579-8190  
URL: http://www.optex.co.jp/

OPTEX INCORPORATED (USA)  
TEL +1-800-950-5710  
Tech (800)950-7239  
URL: http://www.optexamerica.com/

OPTEX (EUROPE) LTD. (UK)  
TEL +44-1628-610000  
URL: http://www.optex-europe.com/

FCC Notice : MX-40PI and MX-50T have been tested and found to comply with the limits for a field disturbance sensor, pursuant to Part 15 of the FCC Rules. The user is cautioned that changes or modifications not expressly approved by OPTEX could void the user's authority to operate this equipment.