

# WS 64-U

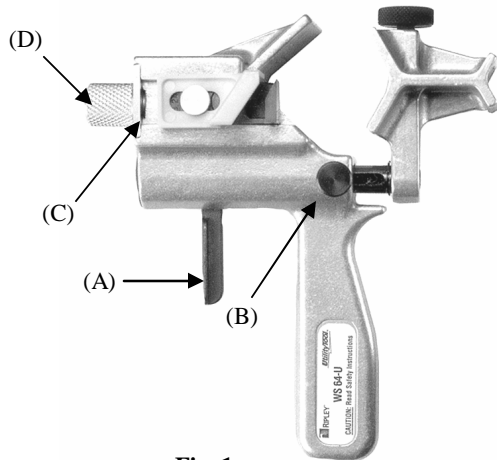
## ADJUSTABLE CABLE STRIPPER

U.S. Patent D437,765

**Warning!** This tool is not protected against electrical shock! Always use OSHA/ANSI or other industry approved eye protection when using tools. This tool is not to be used for purposes other than intended. Please read and understand instructions before using this tool.

### WS 64-U Specifications

This tool has been designed for the removal of encapsulated outer jackets of 1/2" to 2-1/2" (12.70mm to 38.10mm) over all insulation shield construction Concentric, Tape, Flat Strap, LC, and CLX. It will also remove primary and secondary insulation up to 430 mils with the CB 50K blade but is limited to 175 mils with the CB 236 blade.

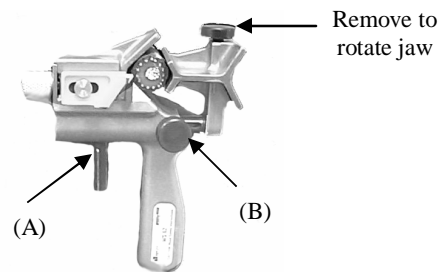


**Fig. 1**

### Instructions For Outer Jacket Removal

-Using End Stripping Blade and Mid Span Stripping Blade-

- Before using this tool, insure the cable has a straight round end
- Use of a curved blade cable cutter or hack saw is recommended



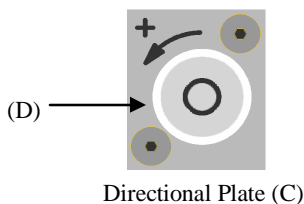
**Fig. 3**

**Fig. 2**

**Fig. 4**

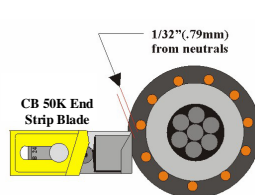
**Step 1.** Squeeze the spring loaded trigger (A) to open the jaws as in Fig. 2 above. Insert the cable between the jaws until it meets the bottom of the cutting blade as in Fig. 3 and 4. Release the spring loaded trigger (A). Tighten knurled knob (B) to lock the tool around the cable.

### Blade Adjustment For Outer Jacket Removal

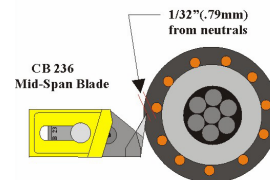


Directional Plate (C)

**Fig. 5**



**Fig. 6**



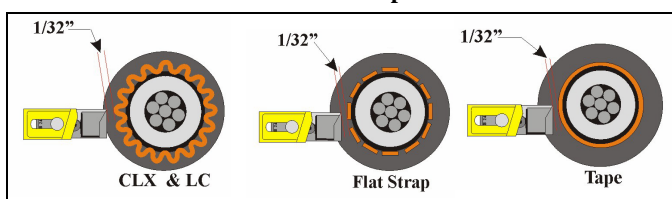
**Fig. 7**

**Step 2.** With the tool secured around the cable, adjust the blade by turning the blade adjustment knob (D) counterclockwise in the direction of the arrow ( Fig. 5) to increase the blade depth into the insulation or clockwise the opposite direction of the arrow ( Fig. 5) to decrease the blade depth setting. Set the blade so it is approximately 1/32" (0.79mm) from the concentric neutral wires as in Fig. 6 and 7.

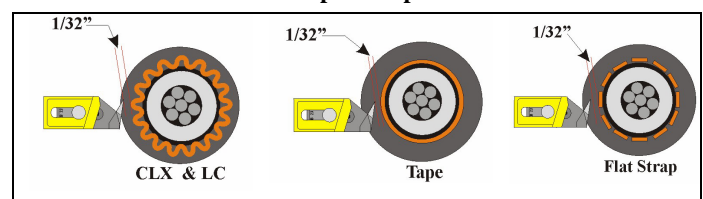
Rotate the tool counterclockwise one complete revolution observing to make sure the blade is consistently 1/32" (0.79mm) or greater from all the concentric neutrals. If the blade makes contact with a concentric wire, move the blade back until it is 1/32" (0.79mm) from the neutral wire by turning the blade adjustment knob clockwise.

### Blade Settings For Jacket Removal Of CLX & LC, Flat Strap, and Tape Shield URD Cable Constructions

#### CB 50K End Strip Blade

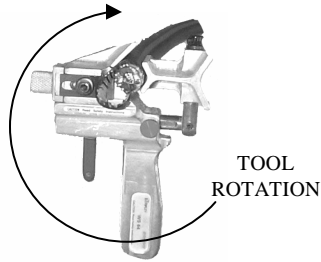


#### CB 236 Mid Span Strip Blade



see other side

## Instructions for WS64-U - Part 2



**Fig. 8**

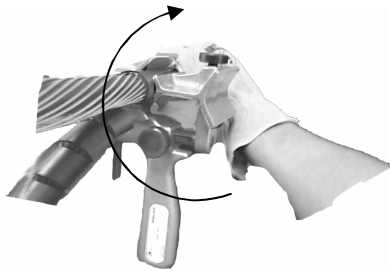
**Step 3.** (Fig. 8 ) Begin jacket stripping by applying a slight downward pressure while rotating the tool around the cable in a clockwise direction. *If the blade slips out of position during jacket removal, do not attempt to restart stripping process. Cut the cable using a curved cable cutter or hacksaw and start over.*



**Fig. 9**

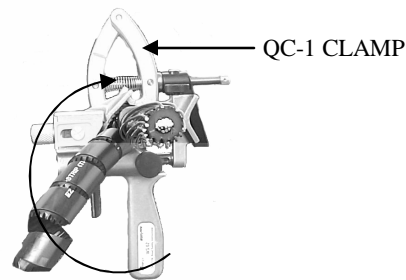
**Step 3.1** (Fig. 9) Continue the stripping procedure until the desired length of jacket has been stripped. It is advisable to “train” the jacket curl so it does not wrap around the cable and interfere with the stripping operation.

*Note: When removing outer jackets that are over flat strap neutrals, it is imperative that the flat straps be taped down after the first complete revolution of the tool. Failure to do so will result in cutting the flat straps due to bird caging.*



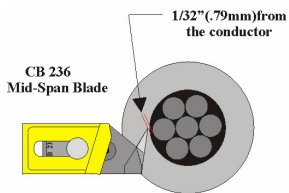
**Fig. 10**

**Step 4.** A square cut on the jacket or insulation can be achieved by stopping the tool’s forward motion with a gloved hand (Fig. 10) or with a Ripley Utility Tool QC-1 Clamp (Fig. 11). If an exact stripping length is required, place the QC-1 Clamp 2” (50.8mm) further down the cable than the desired length when using the CB 50K End Strip Blade and 2 3/8” when using the CB 236 Mid Span Blade.

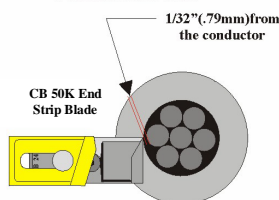


**Fig. 11**

## Removing URD Cable Insulation With The WS 64-U



**Correct Blade Setting For Polyethylene Insulation Without Semi-Con**



**Fig. 11**

### Removing Primary EPR Insulation

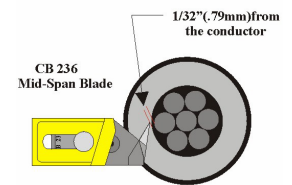
The procedure for removing primary EPR insulation differs slightly than the procedure to remove Polyethylene insulation.

1. When removing EPR insulation, the semi-con insulation shield must be left on as both the semi-con insulation shield and insulation will be removed together.  
\*A nonconductive lubricant should be used on the cable so the tool turns easily around the cable.

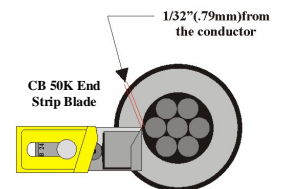
### Removing Primary Polyethylene Insulation

There are 2 options for removing primary Polyethylene insulation

1. Remove the semi-con insulation shield with a Ripley BP1A Banana Peeler and then the primary insulation with the WS 62-U.
2. Leave the semi-con insulation shield on and remove both the insulation and semi-con shield after using a nonconductive lubricant on the cable so the tool turns easily around the cable. Then use the BP1A or BP2A to score the semi-con shield for removal.



**Correct Blade Setting For Polyethylene & EPR Insulation With Semi-Con insulation shield**



**Fig. 12**

Follow the same steps for insulation removal as for outer jacket removal. Refer to Fig. 11 and Fig. 12 for blade setting reference.

Continue to Part 3

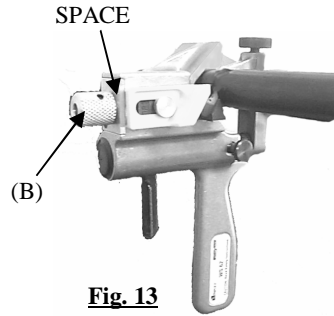
# Instructions for WS64-U - Part 3

## Instructions for Mid Span Stripping Primary Jacketed URD, Aerial Cable and Secondary Cable

**Step 5.** Follow **Step 2** for proper blade adjustment if an end of the cable is available.



**Fig.12**



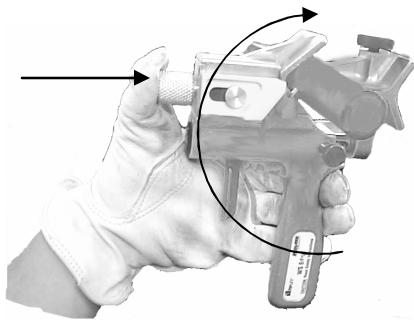
**Fig. 13**

**Step 6.** Before mounting the tool on the cable, turn the knurl knob (B) clockwise until the mid span stripping blade is completely retracted into the tool.

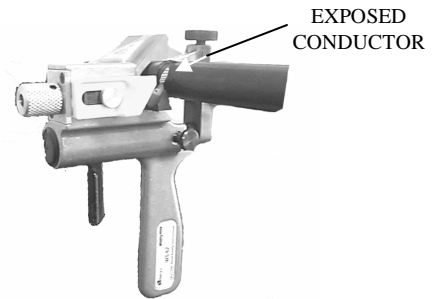
**Note:** *The blade should not be in contact with the surface of the cable when the tool is placed on the cable.*

**Step 7.** To adjust the blade, rotate the knurled knob (B) counter clockwise until a space between knurl knob and the tool is visible.

**Note:** *The space between the knurl knob and tool will represent the depth at which the blade will penetrate the cable covering.*



**Fig. 14**



**Fig. 15**

**Step 8.** To begin stripping operation, place a gloved hand on the tool with the fingers on the handle and the thumb on the knurl knob. Turn the tool around the cable while applying pressure with the thumb to the knurl knob. The thumb pressure will help to drive the blade into the cable shield during the tool rotation around the cable, and begin removal process.

**Step 9.** Rotate the tool around the cable one complete revolution. Carefully adjust the blade depth if necessary avoiding contact with the conductor. When the desired length of conductor is exposed, follow **Step 4** to stop stripping process.

Available Purchase Configurations (blades are interchangeable):

| Model      | Function  | Installed Blade                     |
|------------|---|-------------------------------------|
| WS 64-U-E  | End Stripping Only <ul style="list-style-type: none"> <li>Outer jackets up to 2.5" OD (63.5 mm)</li> <li>Insulation to 1.5" OD, up to 35Kv - 345 mils (8.8 mm) maximum thickness</li> </ul> | CB 50K                              |
| WS 64-U-M  | Mid Span / End Stripping <ul style="list-style-type: none"> <li>Outer jackets up to 2.5" OD (63.5 mm)</li> <li>175 mil (4.4 mm) maximum insulation / covering thickness (15 Kv)</li> </ul>  | CB 236                              |
| WS 64-U-EM | End Strip and Mid Span Stripping  | CB 50K Installed<br>CB 236 Included |



**WARRANTY:** The Ripley Company warrants that our line of tools are free of defect and fully operable at the time of shipment. The warranty is limited to the repair or replacement of any product which proves to be defective in material or workmanship, under normal use and service.



46 Nooks Hill Road  
Cromwell, CT 06416  
Phone: 800-528-8665  
Int'l: (01) 860-635-2200  
Fax: (01) 860-635-3631  
E-mail: info@ripley-tools.com  
Internet: www.ripley-tools.com



37267 rev.2  
08/12/2010 ff