

AMIAD Water Systems

Arkal Spin Klin™ 4" Galaxy

Internal Source

User Guide

Serial number:	_____
Order number:	_____
Catalog number:	_____
Filtration degree:	_____
Tested by:	_____

Installation and Operation Instructions

910101-000513 / 01.2021

AMIAD Water Systems

Arkal Spin Klin 4" Galaxy Internal Source – Service & Maintenance Manual



Image is for illustration only

Disclaimer:

This document and the information enclosed within it contain restricted and/or privileged information that are intended only for usage by authorized Amiad technicians. If you are not a qualified Amiad technician you must not take any action in reliance to this document, unless permitted by Amiad. None of the procedures provided on this file may be used in any form or by any means without permission from Amiad. If you received this file in error please notify Amiad immediately. (reuvan@amiad.com)
The confidential nature of and/or privilege in the file enclosed is not waived or lost as a result of a mistake or error in this file. Amiad accepts no liability whatsoever, whether it was caused by:

1. Accessing or other related actions to this file.
2. Any links, procedures or materials provided/attached to this file.

Amiad assumes that all users understand risks involved within this file and/or its attached materials.

All the procedures, drawings, pictures and/or any other information provided in this document are presented as general information only; they can be altered, removed or changed without any further notice by Amiad.

This document does not replace any certified drawing, procedure or information provided by Amiad in reference to a specific customer, site or project.

All rights reserved.

Table of Contents

1. Introduction.....	4
2. Safety Instructions.....	4
3. Standard System Dimensions	8
4. Description and Operation	9
5. Filter Operation	12
6. Technical Data.....	13
7. Installation and Operation.....	14
8. Galaxy 4" Spin Klin - System Maintenance	16
9. Troubleshooting	22
10. Filter Parts Schedule and Parts List	24
11. Valves Parts Schedule and Parts List	25
11.1. Standard Valves Parts List.....	26
11.2. DW Valves Parts List	26
11.3. AW Valves Parts List	27
11.4. SW Valves Parts List.....	27
12. System Drawing (to be amended per each specific ordered).....	28
13. Amiad Limited Warranty	29

1. Introduction

General

Arkal Filtration Systems congratulates you for purchasing the 4" Spin Klin Galaxy filter. All Arkal's filters are easy to install, use and service and require no special skills to operate. For operation and maintenance of this filter please follow the instructions in this manual. This Arkal 4" Spin Klin Galaxy battery is an automatic self-cleaning filter designed for non-hazardous liquids only and for operation within the pressure parameters described in the specifications table.

2. Safety Instructions

General Safety Instructions

- The manufacturer filtration products always operate as components in a larger system. It is essential for the system designers, installers and operators to comply with all the relevant safety standards.
- Prior to installation, operation, maintenance or any other type of action carried out on the filter, read carefully the installation and operation instructions.
- During installation, operation or maintenance of the filter all conventional safety instructions should be observed in order to avoid danger to the workers, the public or to property in the vicinity.
- The system has to be used for non-hazardous liquids only!
- Please note: The filter enters into a flushing mode automatically, without prior warning.
- No change or modification to the equipment is permitted without a written notification given by the manufacturer or by its representative, on the manufacturer's behalf.
- Always observe standard safety instructions and good engineering practices while working in the filter's vicinity.
- Use the filter only for its intended use as designed by the manufacturer, any misuse of the filter may lead to undesired damage and may affect your warranty coverage. Please consult with the manufacturer prior to any non-regular use of this equipment.
- System's cleaning and maintenance shall be carried out only when explosive atmosphere is not present!

Installation

General

- Install the filter according to the detailed Installation Instructions provided with the filter by the manufacturer and according to the description given in this manual.
- Make sure to leave enough clearance, side and top, so as to enable easy access for future treatments and safe maintenance operations.
- The user should arrange suitable lighting at the area of the filter to enable good visibility and safe maintenance.
- The user should arrange suitable platforms and safety barriers to enable easy and safe access to the filter without climbing on pipes and other equipment. The user should verify that any platform, barrier, ladder or other such equipment is built, installed and used in accordance with the relevant local authorized standards.
- Check and re-tighten all bolts during commissioning and after the first week of operation.
- Use only appropriate standard tools and equipment operated by qualified operators when installing, operating and maintaining the filter.
- When installation is required in hazardous environment sites, underground or high above ground, make sure that the site design and the auxiliary equipment are appropriate and that installation procedures are carried out in accordance with the relevant standards and regulations.
- Ensure walking areas about the installation are slip free when wet.

Shipment and transporting

- Shipping and transporting the filter must be done in a safe and stable manner and in accordance with the relevant standards and regulations.
- For shipping, lifting and positioning the filter, use only approved lifting equipment and authorized employees and contractors.

Electricity

- Electric wiring should be performed by an authorized electrician only, using standardized and approved components.
- The system must be installed with suitable electrical earthing that would prevent any electrostatic discharge from the system.
- Install a **lockable** main power cut-off switch close to the control panel.
- If due to site constraints, the control panel is installed without a clear line-of sight of the filter, an additional **lockable** power disconnect cut-off switch should be installed near each filter unit.
- Installation of the filter should be performed so as to avoid direct water splashing on the electrical components or on the control panel.

Pneumatics

- Install a **lockable** main cut-off switch, **featured with a pressure release mechanism**, on the compressed air supply line close to the control panel.
- If the control panel is installed far away and there is no eye contact with the filter, a **lockable** compressed air cut-off switch, **featured with a pressure release mechanism**, should be installed near each filter unit.
- The user should make sure that the compressed air supplied to the filter never exceeds the maximum designated pressure for this filter. An air-pressure reduction valve should be installed on the compressed air supply line upstream of the filter's pneumatic inlet port.

Hydraulics

- Extra safety devices should be installed on hot water applications to avoid skin burn danger.
- The user should install a manual Water Cut-off Valve next to the filter's inlet port.
- In cases where the downstream piping network downstream of the filter is pressurized an additional manual Water Cut-off Valve should be installed next to the filter outlet port.
- The user should make sure that the system includes a Pressure Release / Drainage Valve to enable release of residual pressure prior to any maintenance procedure performed on the filter.
- The user should make sure that the filter is never exposed to water pressure exceeding the maximum designated pressure for this filter, if needed a Pressure Reduction Valve should be installed upstream of the filter's water inlet port.
- Please note that the maximum working pressure indicated at the filter's specifications table includes the pressure caused by fluid hammer and pressure surge effects.

Civil Engineering

- Make sure that the filter installation is done by a qualified mechanical contractor.
- Make sure that any civil engineering work at the installation site such as construction, lifting, welding, etc. is done by qualified workers / technicians / contractors and in accordance with the relevant local standards.
- While using lifting equipment, make sure that the filter or the lifted part is chained securely and in a safe manner.
- Do not leave lifted equipment if there is no necessity. Avoid working below lifted equipment.
- Wear a safety helmet while using lifting equipment.
- Make sure that the flooring is sloped to for drainage and to avoid accumulation of liquids.

Commissioning

- Read carefully the Commissioning and the First Start-up Operation instructions prior to any attempt to operate the filter.
- In order to achieve maximum performance and smooth operation of the filter it is crucial to perform the startup and first operation procedures exactly as described in this manual.
- Commissioning the filter should be done by an authorized manufacturer technician, do not attempt to commission the filter unaccompanied since this may lead to undesired damage and may affect your warranty coverage.

Operation and Control

- Do not operate the filter before reading carefully and being familiar with its operation instructions.
- Observe the safety stickers on the filter and never perform any operation contradicting the instructions given.
- Never operate or use the filter for purposes other than its original design and operational envelope.
- The system must be used for non-hazardous liquids only!
- System's cleaning and maintenance shall be carried out only when explosive atmosphere is not present!

Maintenance

Before any maintenance or non-regular operation

- Servicing the filter should be done only by technicians authorized by the manufacturer.
- System's cleaning and maintenance shall be carried out only when explosive atmosphere is not present!
- Disconnect the filter from the power supply and lock the Main Power Switch.
- Disconnect the compressed air supply, release the residual pressure and lock the Pneumatics Main Valve.
- Disconnect the filter from the water system by closing and securing the manual inlet valve. In cases where the downstream piping network is pressurized, close and secure the manual outlet valve also.
- Release the residual water pressure by opening the pressure release / drainage valve.
- Empty the filter by opening the drainage valve.
- In hot water systems wait till the filter components cool off to a safe temperature.
- Place warning signs around the work area as required by the local standards and procedures.
- Inspect the filter's safety stickers and replace any damaged or faded sticker.

Special Note

Before opening the filter lock, check that there is no pressure in the filter.

3. Standard System Dimensions

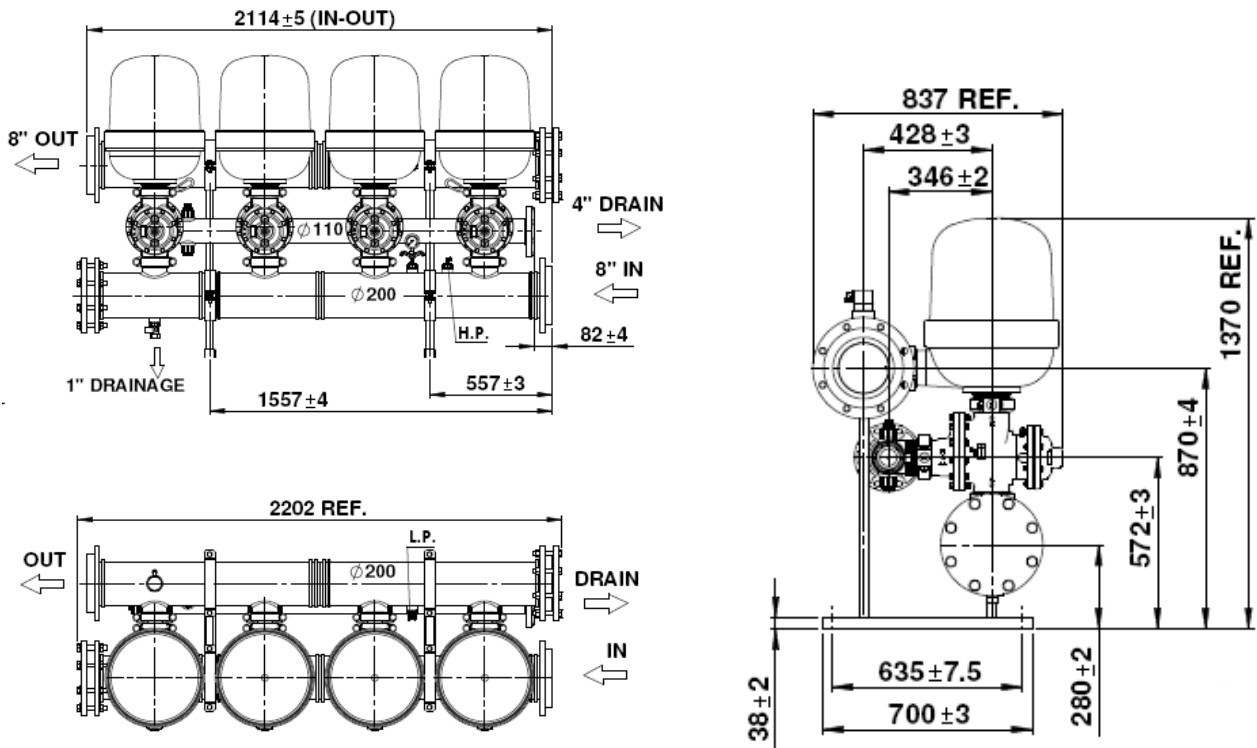

Description	Number of Filters	A (Length)		B (Height)		C (Width)	
		mm	inches	mm	inches	mm	inches
$\phi 10''$ Inlet & Outlet Diameters	3	1845	72.6	1340	52.8	1520	59.8
	4	2345	92.3	1340	52.8	1520	59.8
$\phi 12''$ Inlet & Outlet Diameters	3	1845	72.6	1360	53.5	1520	59.8
	4	2345	92.3	1360	53.5	1520	59.8

4. Description and Operation

Disc Filtration Technology

Arkal Filtration Systems uses a specially designed disc filtration technology. Thin, color-coded polypropylene discs are diagonally grooved on both sides to a specific micron size. A series of these discs are then stacked and compressed on a specially designed spine. When stacked, the groove on top runs opposite to the groove below, creating a filtration element with a statistically significant series of valleys and traps for solids. The stack is enclosed a corrosion and pressure resistant housing.

During the filtration process, the filtration discs are tightly compressed together by the spring's power and the differential pressure, thus providing high filtration efficiency. Filtration occurs while water is percolated from the outer diameter to the inner diameter of the element. Depending on the micron rating, there are from 18 (in 400 micron discs) to 32 (in 20 micron discs) stopping points in each track, thus creating the unique in-depth filtration.

Table of Filtration Grades of the Discs and Color Code

Color Code	Light Blue	Gray	Purple	Green	Brown	Black	Red	Yellow	Blue
Micron	10	20	40	55	70	100	130	200	400
PP / PA (Nylon)	PP	PP, PA	PP	PP, PA	PP, PA	PP, PA	PP, PA	PP, PA	PP

**PP discs are standard Arkal, PA discs available on request*

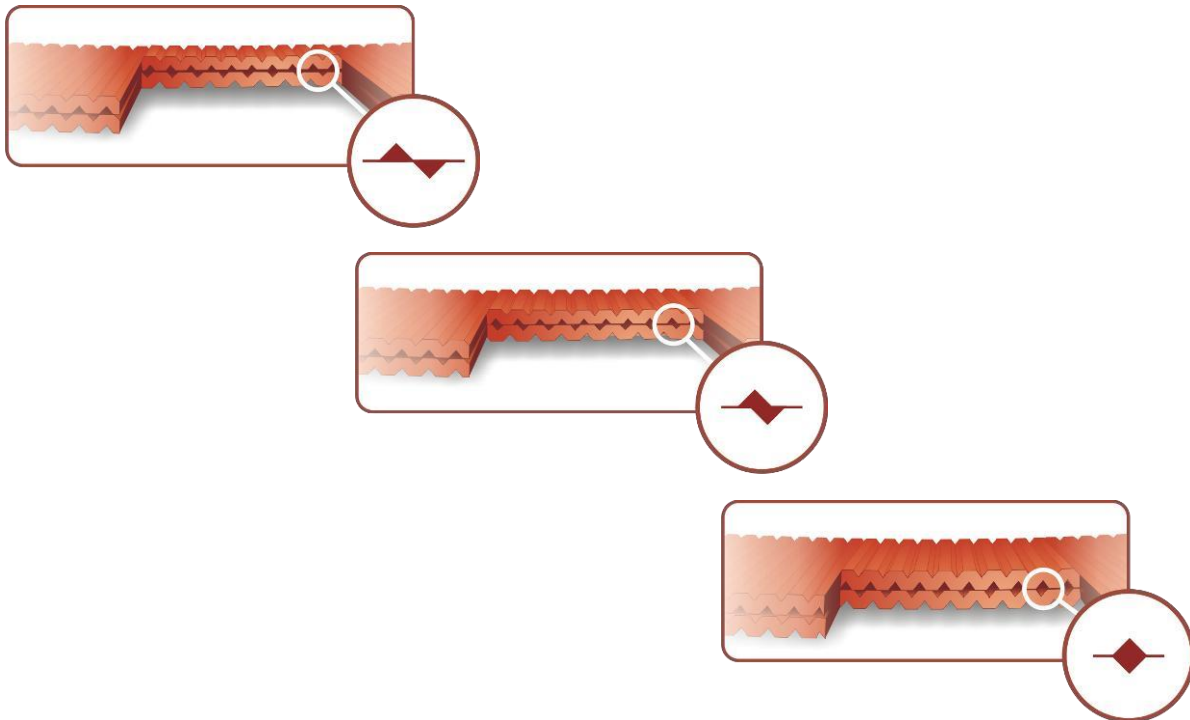

Spin Klin Technology

Spin Klin Spine - The Core of the Spin Klin Filtration System

The Spin Klin[®] discs are stacked on the Spin Klin[®] spine. The discs are color-coded according to micron size, and are assembled to suit your water filtration requirements. The spine assembly has a spring compression unit and an internal piston, which operate during alternate filtration or back-flush modes. Inside the housing a spring and the pressure difference compress the discs tightly during the filtration process, forcing the water to flow between the grooves and trap the solids.

Spin Klin Automatic Back-flush Operation

Activated by an external command (differential pressure or time) alternate units of the Spin Klin[®] system go into back-flush mode. Three-way valve closes the inlet to the filter pod and opens the drain. During the back-flush process, the compression spring is released, and the pressure difference is eliminated. The spine piston rises up, releasing the pressure on the discs. Tangential jets of clean water are pumped at high pressure in the opposite direction through nozzles at the center of the spine. The discs spin free and clear, loosening the trapped solids. Solids are quickly and efficiently flushed out through the drain.

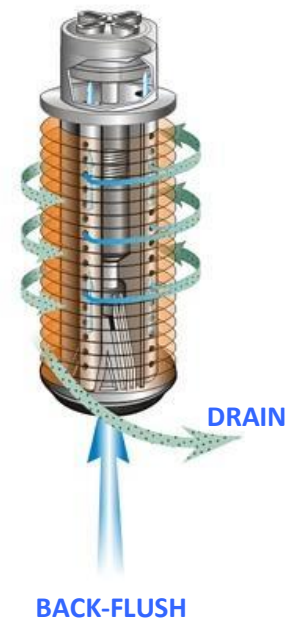
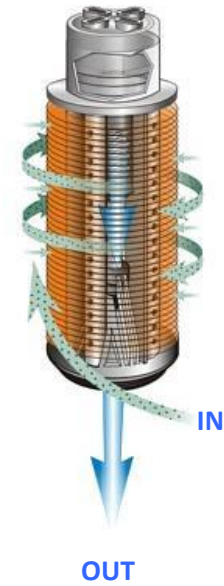

Modes of the filter's Control valve

Filtration Position:

Water flows from port [2] (main supply) to port [C] (filter connection). Port [1] (drain water outlet) is closed by the seal.

Back-flush Position:

Command pressure is applied to the diaphragm's control chamber through port [D]. The diaphragm moves the sealed shaft, port [2] closes, preventing flow to the filter. Port [1] opens, allowing flushing water to flow from port [C] (filter connection) to the drain

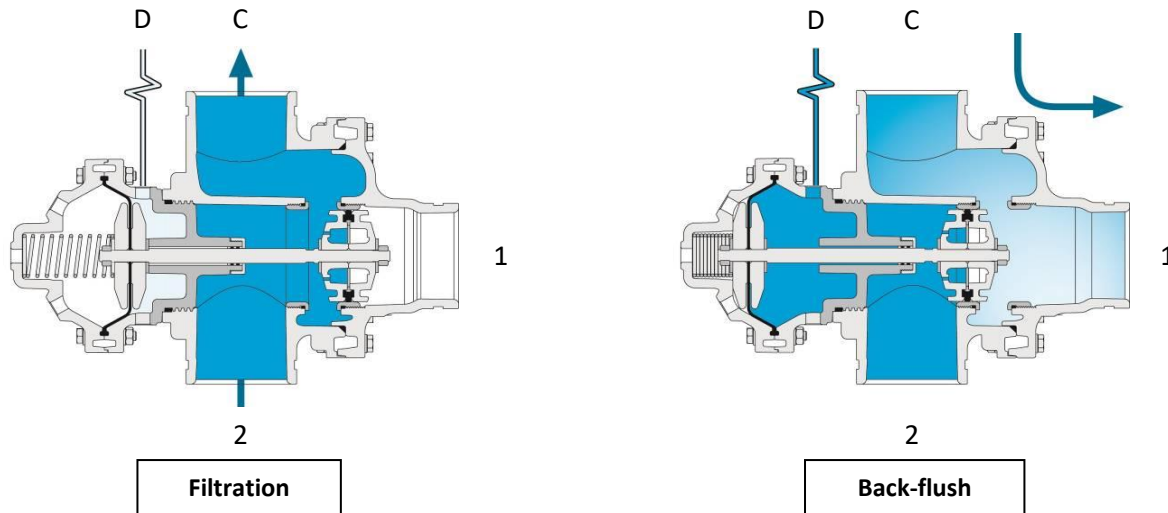

Modes of Operation

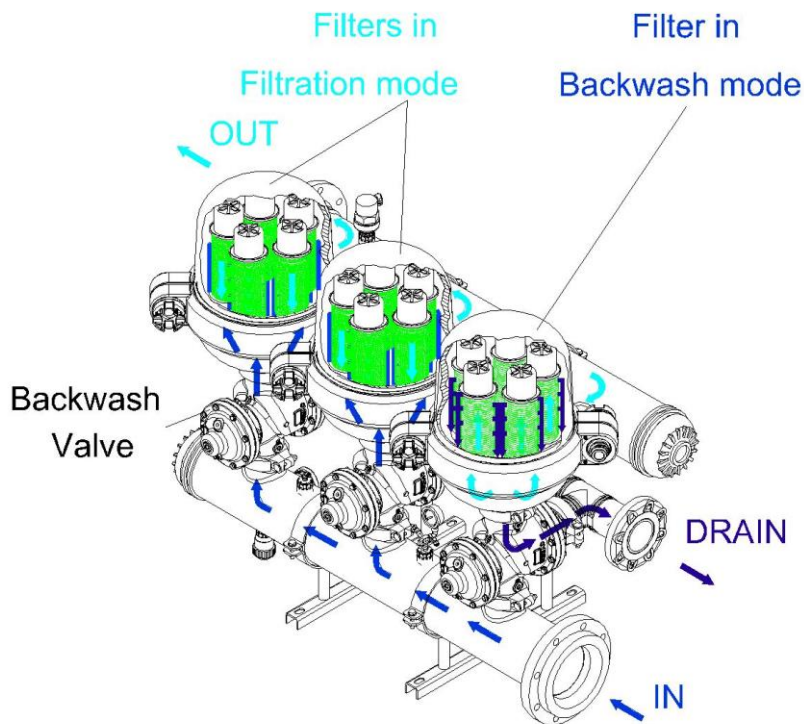

5. Filter Operation

Filtration Process

During the filtration process the water flows through the inlet manifold into the filters through their 4"x4" inlet valves. The filtered water flows through the outlet manifold of the system.

Back-flush Process

The back-flush process begins with a signal from the control unit activated by the pressure difference between the inlet and the outlet or by a time interval.

A signal is transported to the 4"x 4" inlet valve of the first filter pod causing the valve to close the 4" inlet to the filter and to open the 4" drain port. Filter No.1 is now in a back-flush mode.

The 5 Spin Klin spines of filter pod No.1 operate simultaneously, releasing the compressed discs. Tangential jets of water are pumped against the discs, causing them to spin fast and free, flushing trapped solids out to the drain.

Filtered water for the back-flush process is supplied by a different external water source rather than by the filter's water as in regular flushing.

The back-flush time per filter is 20-30 seconds. When the time elapses the control, unit stops the back-flush signal to the solenoid.

The solenoid releases the water pressure signal allowing the inlet valve and the discs of the 5 spines to return to filtration mode.

Once filter No.1 is in the filtration mode again the control unit sends a signal to begin the back-flush process of filter No.2.

6. Technical Data

Parameters	METRIC	US
Maximum pressure	10 bar (25° C)	145 (77 °F)
Minimum working pressure	1.0 bar	14.5 psi
Minimum pressure for back-flush:		
400µ-130µ	3 bar	45 psi
100µ-70µ	4 bar	60 psi
50µ-20µ	5 bar	75 psi
Back-flush flow rate per single pod:		
400µ-130µ	50 m ³ /hr	220 gpm
100µ-70µ	55 m ³ /hr	250 gpm
50µ-20µ	55 m ³ /hr	250 gpm
Maximum temperature	60 °C (@4 bar)	158 °F (@58 psi)
PH	4-11	4-11

Construction Materials	
Filter Housing & Lid	PP (Polypropylene) RPA (Reinforce Polyamide)
Disc elements	PP (Polypropylene)
Backwash valves	RPA (Reinforce Polyamide)
Manifolds	PP (Polypropylene)
Seals	NBR or EPDM, (Viton optional)
Control Tubing	PE or PA

7. Installation and Operation

Installation

- A. Check for any transport damage (the system operates under pressure!).
- B. Make sure that the inlet and outlet flow orientations are correct (shown by arrows on the system).
- C. Connect the Inlet the Outlet and the Drain ports together with their valves to the Main Manifolds.
- D. Verify that all the covers' clamps are properly closed!
- E. Connect and check the water source pressure.
- F. Connect the Air pressure source to the solenoid. Adjust air pressure to 1 bar (14 PSI) higher than inlet water pressure. (Applied only to system with compressed air command).

Start-up Operation

- A. Gradually open the inlet valve (make sure that the outlet valve is partially open).

WARNING Take precaution while operating the system as it may enter to back-flush mode automatically, without warning.

- B. Check the system assembly and its connections for leaks.
- C. Perform a back-flush cycle by disconnecting the low-pressure tube from the differential pressure indicator (closing the electrical circuit) make sure to re-connect it immediately as the back-flush cycle starts.
- D. Verify that the back-pressure reading during back-flushing is according the recommended pressure for your system specific filtration degree.
- E. When the filter is clean, verify that the differential pressure between the inlet and the outlet ports does not exceed 1.5-2m (2-3 PSI).
- F. Check that the differential pressure indicator is set for starting a back-flushing cycle at 5m (7 psi)
- G. Perform an additional back-flushing cycle manually by rotating the operation handle (turn clockwise 90°) located on the solenoid valve. Make sure to rotate the handle back to automatic mode once the back-flushing starts.

Please note:

The electronic controller is not included. The P&ID drawing is an example of a system with 5 filters.

Control

- Refer to the manufacturer’s handbook before installing the controller.
- Make sure that the voltage of both the solenoid unit and controller are correct.
- Check that the ΔP hydraulic switch HIGH and LOW pressure lines are correctly connected to the appropriate ports.
- Set the starting back-flush switch to the required ΔP (Recommended ΔP will range between 5m- 7PSI according to site conditions).
- Set the controller to a flush time of 15-20 seconds and a dwell time of 10 seconds. These settings may require adjustment to conform to local water conditions. Typically, a 1 to 2 hour interval between back-flush cycles is recommended.

Control Scheme –

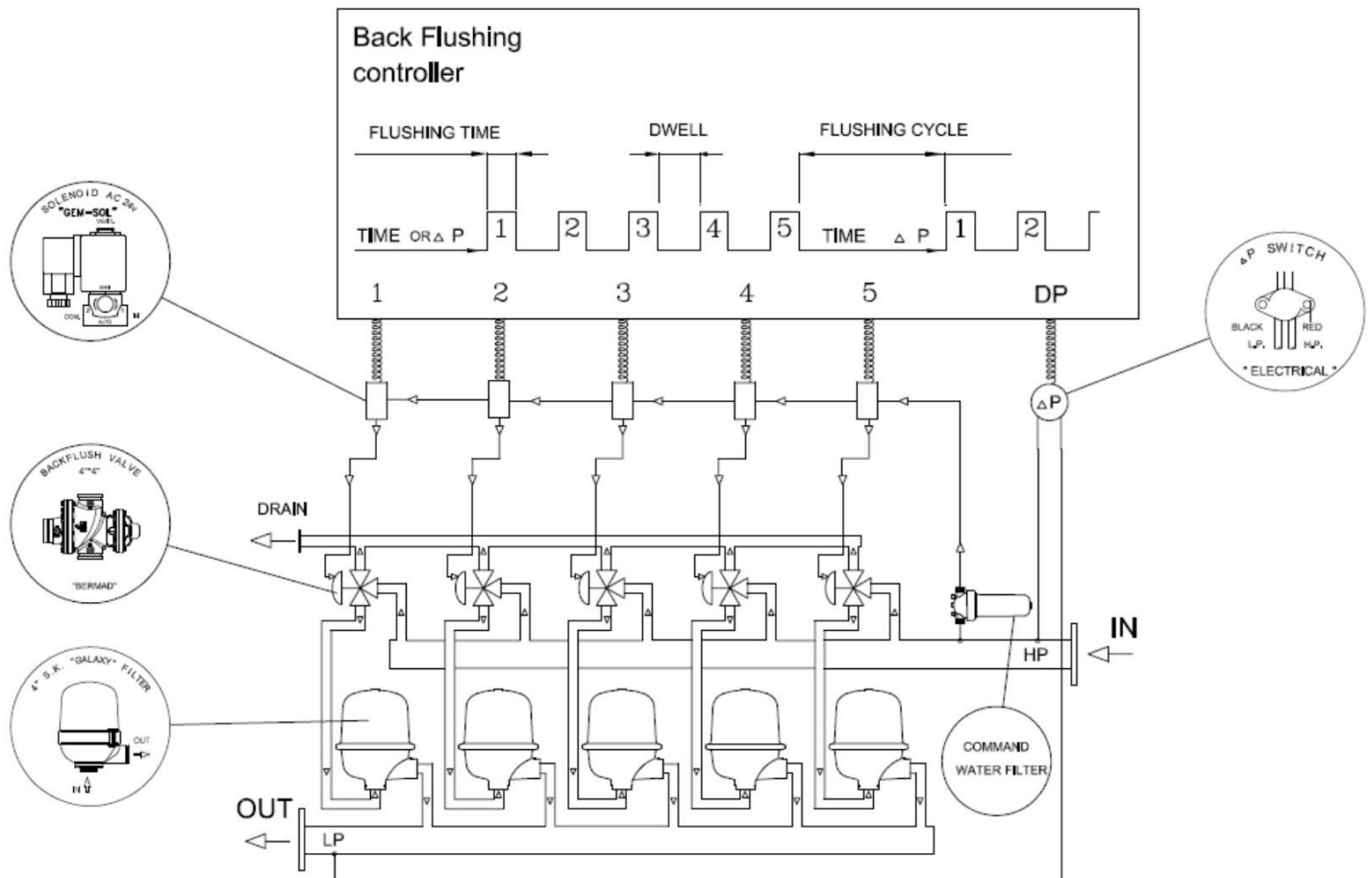

8. Galaxy 4" Spin Klin - System Maintenance

Monthly Maintenance

Check the inlet /outlet pressures:

When the pressure differential is above 5m / 7 PSI, activate automatic back-flush of the Spin Klin system. In the event that the pressure differential remains high, check for possible failures.

Check for leakages from the drain manifold:

When there is a leakage of water to the drain during the filtration stage, check for possible failure of the back-flush valve seals.

Back-flush controller performance:

Check that the controller timing parameters are correctly adjusted and activate the automatic back-flush cycle. In the event of a back-flush controller malfunction, check for possible failures.

Cleaning of the Command Filter:

Close the command-filter inlet valve, release the pressure trapped in it and remove the cover. Thoroughly clean the filtration element, then reinstall the command filter element and cover and open the inlet valve. (Not applied to compressed air-controlled systems).

Winterization:

In order to prevent the filter battery becoming damaged during water freezing – drain all the water from the filter battery and the command filter and leave the drain valve open.

To avoid damage or breakage, the filter, solenoid and command tubes, must be drained prior to frost periods. A step by step instructions:

1. Initiate a manual flush to make sure that the disc element will be clean for the shutoff period.
2. Close the isolation valves (inlet and outlet if exist).
3. Initiate an additional manual flush to release the pressure inside the filter.
4. Open the system drain valve.
5. Disconnect the tubes that supply water to the solenoid and to the controller sensors.

NOTE:

Before performing any maintenance work on the battery, make sure all water and air connections are disconnected and that the pressure has been released

SEASONAL MAINTENANCE - DISCS

To guarantee thorough cleaning the following steps should be taken:

Close the water inlet after back-flushing the systems. Make certain that there is no pressure in the system and unscrew the nuts. **(Figure 1)**

(Figure 1)

Open the clamp. **(Figure 2)**

Remove the cover. **(Figure 3)**

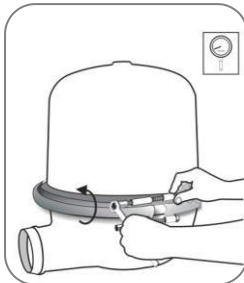

Figure 1



Figure 2



Figure 3

Unscrew the butterfly nuts on the filtration elements. **(Figure 4)**

Remove the tightening cylinders. **(Figure 5)**

Remove the disc sets (for convenience we recommend using a plastic bag).

(Figure 6)

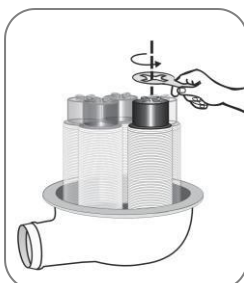

Figure 4

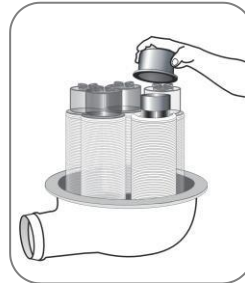

Figure 5

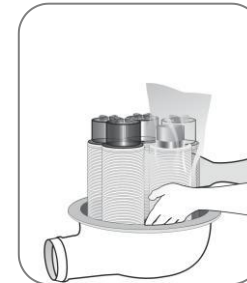

Figure 6

Tie each set on a string and place them in a cleaning solutions (HCL, Chlorine, or other) refer to the "Cleaning Recommendations for Clogged Filtration Discs". **(Figure 7-8)**



Figure 7

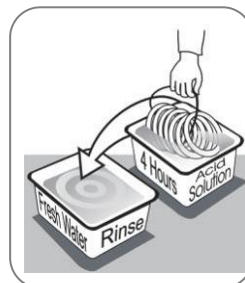

Figure 8

Ensure that the correct quantities of discs are assembled on the spines: when the discs are pressed with two hands, the top disc should be level with the imprinted circle on the outside of the spine. **(Figure 9)**

Reassemble the tightening cylinders onto the spines, return the cover and tighten the clamp. **(Figure 10)**

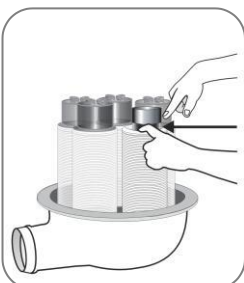

Figure 9

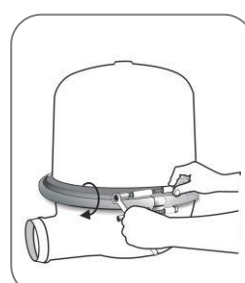

Figure 10

Attention:

When carrying out any of the following seasonal maintenance, service, or cleaning the discs – After back-flushing the system and after closing the water inlet, **make certain that there is no pressure in the system!**

Unscrew the nuts and open the clamp.

Please Note:

- Before removing the cover, you may experience the vacuum phenomenon which will make the removing of the cover very difficult or almost impossible.
- **Do Not** - insert any sharp tools (objects) in between the cover and the body! You may damage the hydraulic seal and the cover!
- In order to remove the cover easily – **you should drain the water from the system!**
- You can drain the system through the command filter, or the back flush valves, once the system is empty the cover can then be removed safely and easily.

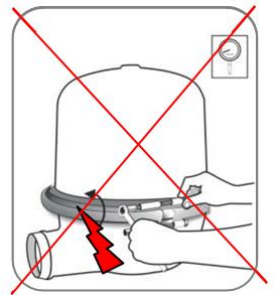
**Closing torque:**

- 2" SK BUTTERFLY NUT - 10 Nm - (7.4 ft-lb)
- SPINE MODEL 2.8 - 70 Nm - (51.6 ft-lb)
- CLAMP SCREW - 200 Nm - (147.5 ft-lb)

Cleaning Recommendations for Clogged Filtration Discs

Water-formed deposits may cause clogging of the filter discs. The formation of these deposits depends on the quality of the filtered water and environmental conditions like temperature, pH, light, duration of filtration and more.

Common water-formed deposits are:

- Biological or organic deposits (mostly mucous or oily to the touch, beige, brown or green in color)
- Iron oxide (rust) or other metal oxides
- Carbonates (white or gray deposit)
- Combinations of the above

If these deposits cannot be eliminated by pretreatment of the water, we recommend the following cleaning procedure:

Material and Equipment

- A well ventilated working place.
- 2 small containers (1 liter), 2 large containers (15 liter) and a stirring stick, all resistant to chemicals, preferably of polypropylene.
- Plastic rope to tie up the disc.
- Sodium Hypochlorite NaOCl -
- Strong oxidizing liquid, commercial concentration: 10%. Oxidizes and removes organic and biological deposits.
- Hydrochloric Acid HCl -
- Very corrosive liquid, commercial concentration: 30%.
- Dissolves and removes carbonates, iron oxide, and other deposits.
- Safety equipment: safety glasses, gloves, long pants, long sleeved shirt and shoes.

ATTENTION!

While working with chemicals protect yourself with the necessary safety equipment:

- Safety glasses, gloves, protective clothing
- Work in a well-ventilated area
- Follow the manufacturer's instructions

Cleaning Organic and Biological Deposits

- Open the filter and remove dirty discs.
- Attention – Never open the filter before the pressure has been released.
- Arrange the discs loosely on the plastic rope
- Prepare a 5% Sodium Hypochlorite solution:
- Pour 5 liters of water into one of the large containers.
- Add 5 liters of Sodium Hypochlorite (10%) into the water.
- Soak the discs in the solution so that both sides are covered. To achieve maximum cleaning, agitate the discs several times with a stirring stick.
- Contact time with cleaning solution: up to 8 hours
- Remove the discs carefully from the solution, put them in the second large container and rinse them very well with clean water before placing them back in the filter.
- We recommend flushing the cleaned discs again in the filter to ensure that all chemical residues are removed.

The cleaning solution can be used for several sets of discs. As the cleaning activity of the solution deteriorates, it may be necessary to soak the discs for a longer time.

Cleaning Carbonates and Iron Deposits

- Open the filter and remove the dirty discs.
- Arrange the discs loosely on the plastic rope.
- Prepare a 5% Solution of Hydrochloric Acid:
 - Pour 10 liters of water into one of the large containers.
 - Carefully add 2 liters of Hydrochloric Acid (30%) into the water. Soak the discs in the solution so that both sides will be covered.
 - PLEASE NOTE: Carbonates react violently with hydrochloric acid (foaming, gas evolution). To achieve maximum cleaning, agitate the discs several times with a stirring stick.
- Contact time with cleaning solution: 1 - 8 hours.
- Remove the discs carefully from the solution and rinse them well with clean water before placing them back in the filter.
- We recommend flushing the cleaned discs again in the filter to ensure that all chemical residues are removed.

The cleaning solution can be used for several sets of discs. It may be necessary to soak the discs for a longer period of time as the cleaning activity of the solution deteriorates.

Cleaning Complex Deposits

If the composition of the deposit is not known, perform the following test:

- Take 5 discs for the test.
- Soak 2 discs in a 5% Sodium Hypochlorite Solution.
- Preparation of the solution:
- Pour 1 cup of water into a small container, then add 1 cup of Sodium Hypochlorite (10% NaOCl).
- Soak 2 discs in a 5% Hydrochloric Acid Solution.
- Preparation of the solution:
- Pour 2½ cups (= 500ml) of water into a small container, then add carefully
- ½ cup (= 100ml) of Hydrochloric Acid (30% HCL).
- Keep one disc as a control.
- Observe the cleaning process:
- If one of the solutions removes all of the deposit, clean the discs in that solution according to the instructions above.
- If neither solution removes the deposit completely, continue with the test procedure.
- Remove the discs from both solutions, rinse them well with water and soak them in the second solution: put the two discs, which have been in the Sodium Hypochlorite Solution, in the Hydrochloric Acid Solution, and the other way around.
- Check the cleaning process:
- If one of the treatments removes all of the deposit, clean all of the discs following the same two-step procedure in the exact same order. Rinse the discs well between the two cleaning processes. If the deposit hasn't been completely removed, send a set of untreated discs to the laboratory for further examination.

9. Troubleshooting

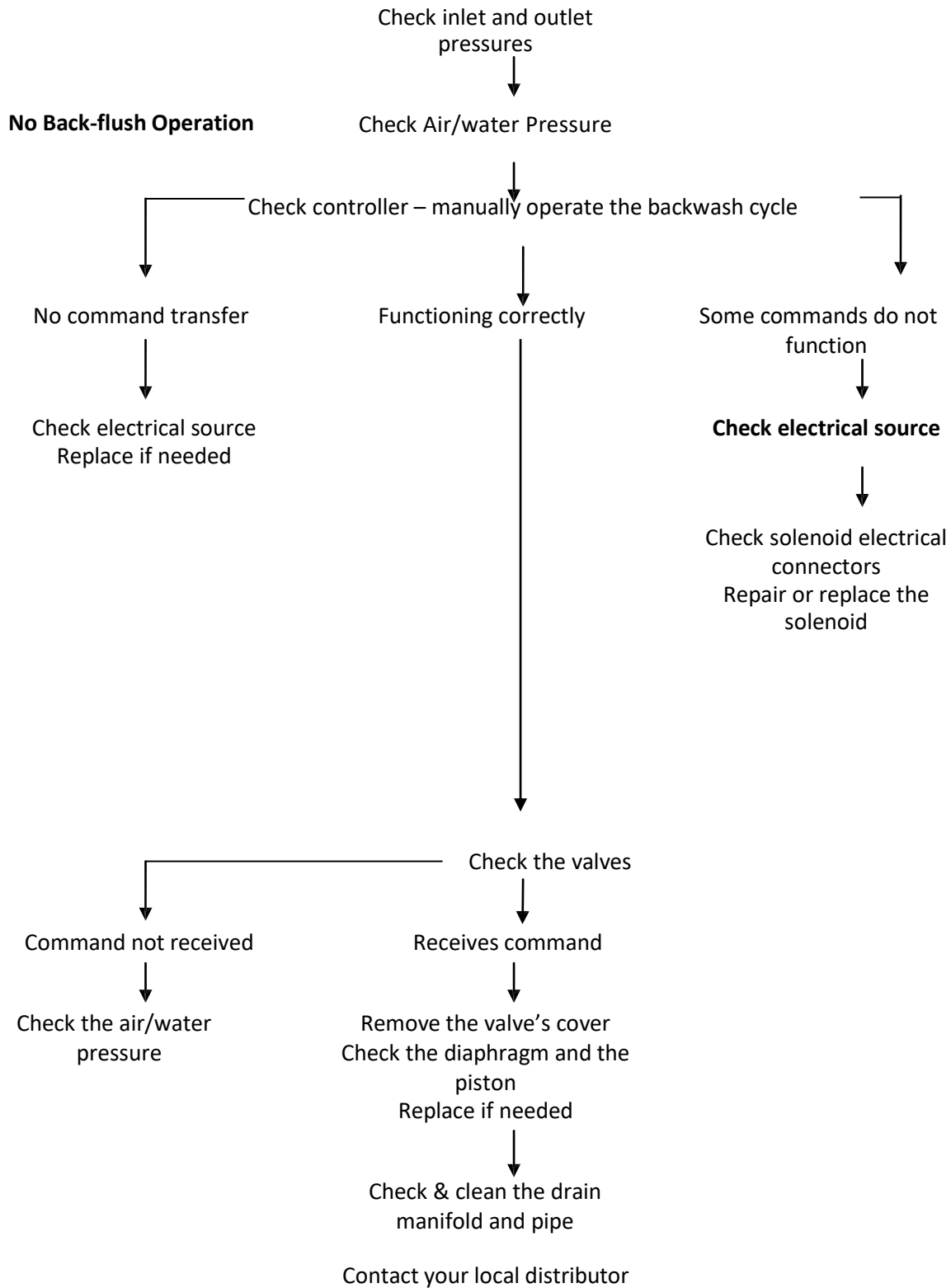

Identifying Malfunctions in the Galaxy system

Continuous or Non-stop Backwashing

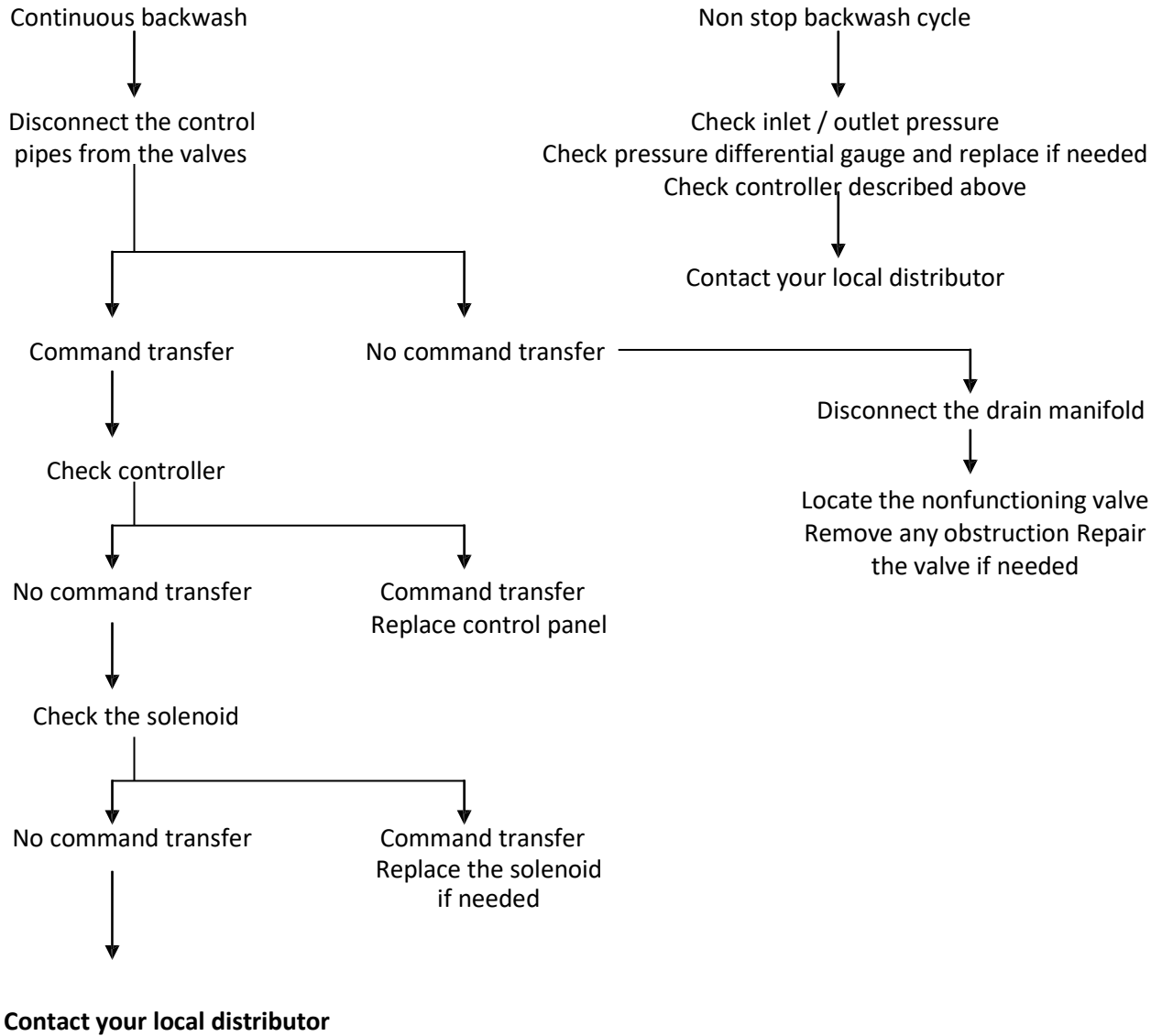

11. Valves Parts Schedule and Parts List

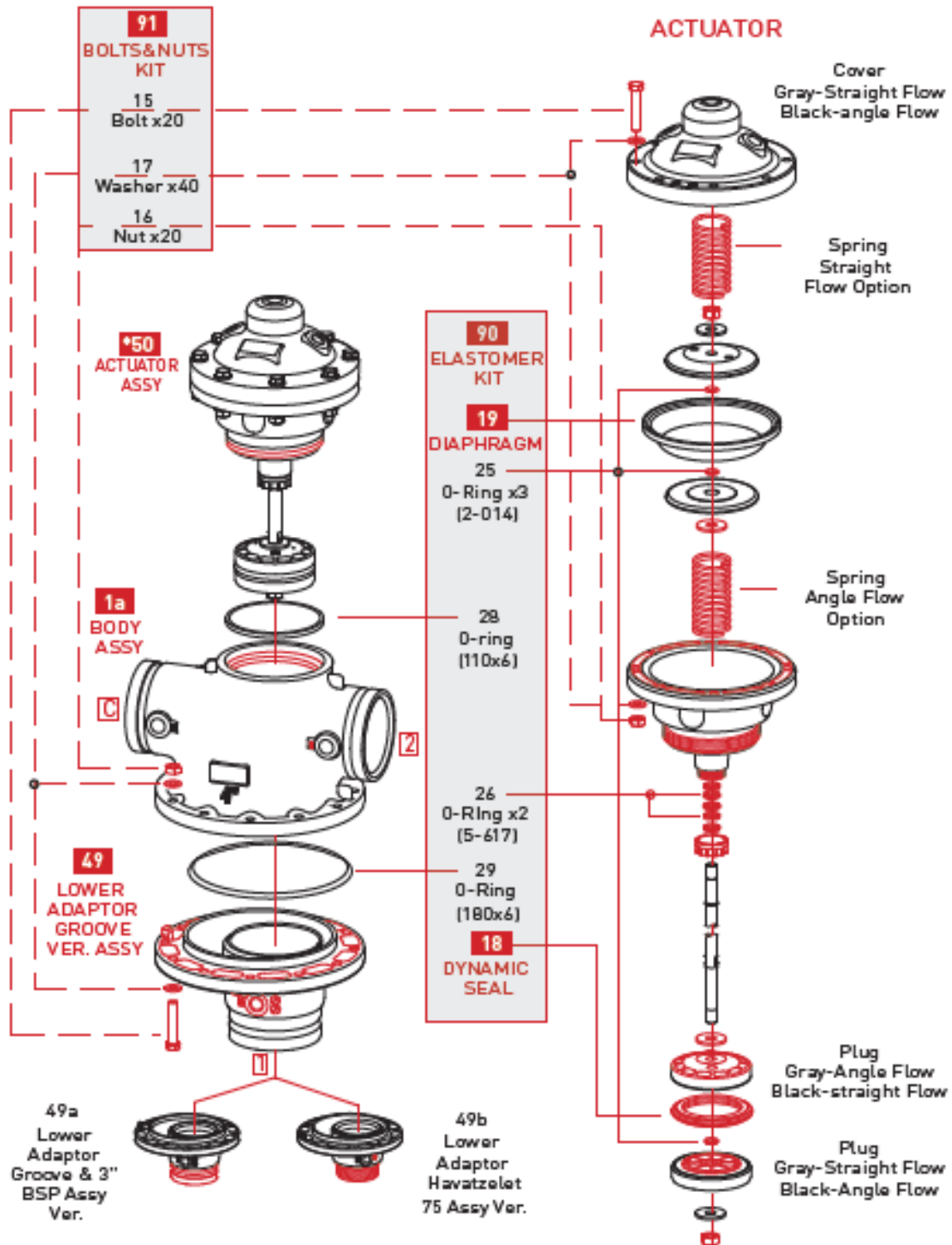

* According to valve type

11.1. Standard Valves Parts List

STRAIGHT FLOW 4X4 350 GROOVED/HVAZELET RPA BLACK BERMAD	730102-000193
STRAIGHT FLOW 4X4 350 GROOVED RPA BLACK BERMAD	730102-000194

No.	Description	Cat. No.
1a	BODY ASSY. F/4" VALVE PLASTIC BERMAD	730113-000568
49	ADAPTOR 4" HVAZELET F/4" VALVE PLASTIC BERMAD	730113-000569
	ADAPTOR GRV F/4" VALVE PLASTIC BERMAD	730113-000573
50	ACTUATOR F/4" STRAGHT FLOW BERMAD	730113-000575
90	SEALS + DIAPHRAGM KIT F/4" VALVE PLASTIC BERMAD	730113-000570
19	DIAPHRAGM F/4" BERMAD (350) NR	730113-000786
18	SEAL F/4" VALVE NBR BERMAD	730113-000484
91	BOLTS-NUTS KIT F/4" VALVE PLASTIC BERMAD	730113-000566

11.2. DW Valves Parts List

STRAIGHT FLOW 4X4 350 GROOVED RPA BLACK BERMAD DW	730102-000291
--	----------------------

No.	Description	Cat. No.
1a	BODY ASSY. F/4" 350 BLACK PLASTIC BERMAD GRV DW	730113-000879
49	LOWER ADAPTOR F/4" 350 BLACK PLASTIC BERMAD LONG GRV DW	730113-000878
50	ACTUATOR ASSY. F/4" STRAIGHT FLOW PLASTIC BERMAD DW	730113-000876
90	ELASTOMERS KIT F/4" 350 BERMAD DW	730113-000868
19	DIAPHRAGM F/4" 350 EPDM BERMAD DW	730113-000877
18	SEAL F/4"/3" VALVE EPDM BERMAD DW	730113-000880
91	BOLTS-NUTS KIT F/4" VALVE PLASTIC BERMAD	730113-000566

11.3. AW Valves Parts List

STRAIGHT FLOW 4X4 350 GROOVED RPA BLACK AGGRESSIVE WATER BERMAD

730102-000199

No.	Description	Cat. No.
1a	BODY ASSY. F/4" 350 BERMAD WA	730113-000785
49	ADAPTOR F/4" W/S/ST316 SEAT	730113-000742
50	ACTUATOR ASSY. F/4" STRAIGHT FLOW S/ST316	730113-000578
90	SEALS + DIAPHRAGM KIT F/4" VALVE PLASTIC BERMAD	730113-000570
19	DIAPHRAGM F/4" BERMAD (350) NR	730113-000786
18	SEAL F/4" VALVE NBR BERMAD	730113-000484
91	BOLTS-NUTS KIT F/4" VALVE PLASTIC BERMAD	730113-000566

11.4. SW Valves Parts List

STRAIGHT FLOW 4X4 350 GROOVED RPA/DUPLEX BLACK SW BERMAD

730102-000202

No.	Description	Cat. No.
1a	BODY ASSY. F/4" WA-S.DUPLEX	730113-000583
49	LOWER ADAPTOR F/4" WA-S.DUPLEX	730113-000582
50	ACTUATOR ASSY. F/4" STRAIGHT FLOW SUPER DUPLEX	730113-000579
90	SEALS + DIAPHRAGM KIT F/4" VALVE PLASTIC BERMAD	730113-000570
19	DIAPHRAGM F/4" BERMAD (350) NR	730113-000786
18	SEAL F/4" VALVE NBR BERMAD	730113-000484
91	BOLTS-NUTS KIT F/4" VALVE PLASTIC BERMAD	730113-000566

12. S)

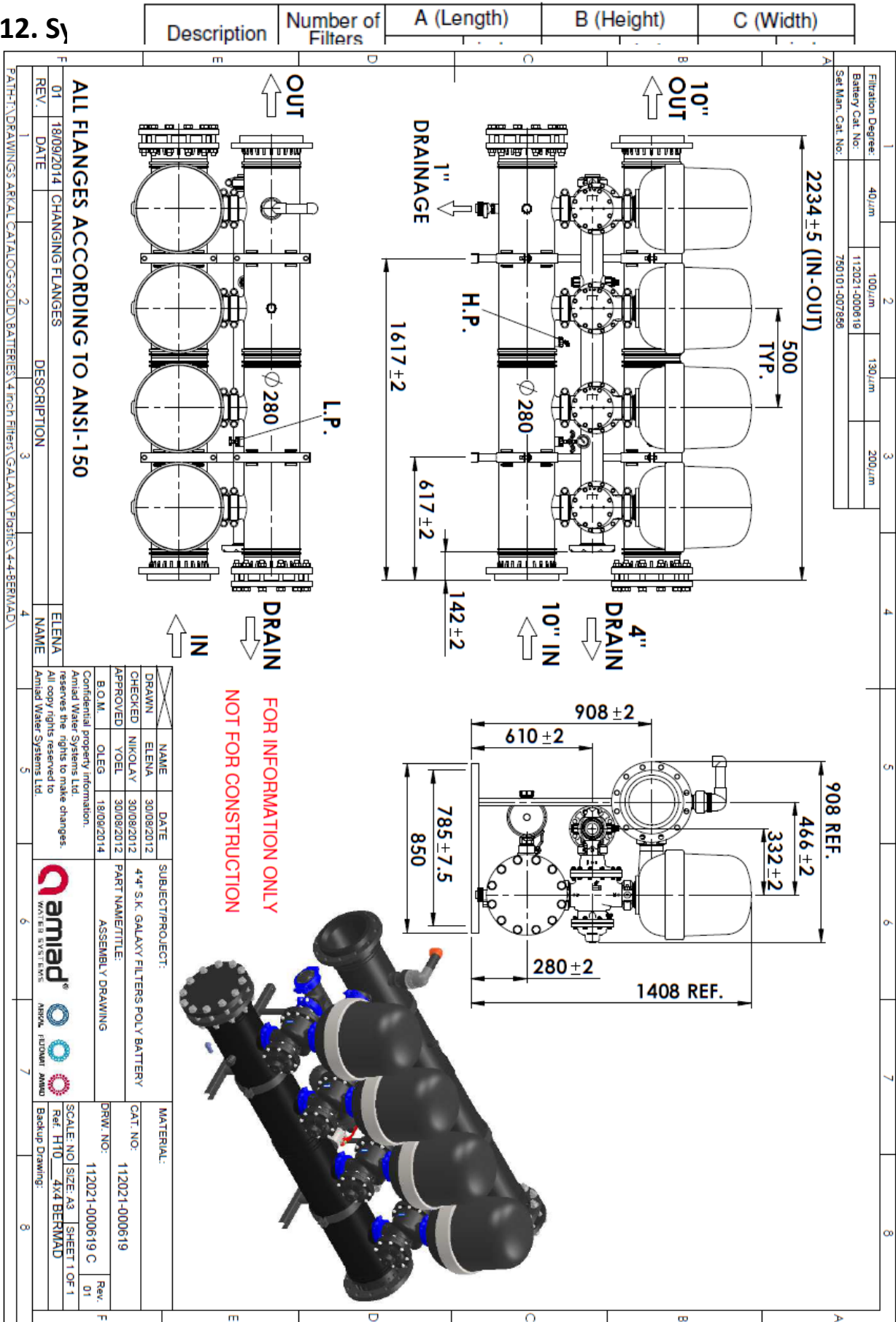

Thursday, September 18, 2014 8:02:25 AM

13. Amiad Limited Warranty

1. This certificate applies to Amiad Water Systems Ltd. ("**Amiad**") products purchased by you (the "**Buyer**") from Amiad unless specifically agreed otherwise in writing by Amiad. This Warranty extends only to the original purchaser, and is not transferable to anyone who subsequently purchases, leases, or otherwise obtains the product from the original purchaser.
2. Amiad hereby warrants that the products are and will be free from defects in material and workmanship under normal use and service. Amiad warrants that it will correct manufacturing defects in the products, in accordance with the conditions set out in this Warranty.
3. This Warranty is enforceable for a period of 12 months after the date upon which the products were delivered (the "**Warranty Period**").
4. In the event that during the Warranty Period the Buyer discovers a defect in material and/or workmanship in any product or part (the "**Defective Product**"), it shall submit a written complaint to Amiad using Amiad's standard Buyer Complaint Form. For the receipt of the Buyer Complaint Form, the submission of the complaint or any questions please contact your service representative.
5. Upon written demand by Amiad the Buyer shall return the Defective Product - or a sample thereof - to Amiad, at Amiad's cost. If the Buyer ships any such Defective Product, Amiad suggests the Buyer package it securely and insure it for value, as Amiad assumes no liability for any loss or damage occurring during shipment. Provided however that in the event Amiad determines that this Warranty does not apply to such product, Buyer shall promptly reimburse Amiad for such cost (including freight and customs). Any returned product or part must be accompanied by the Warranty certificate and the purchase invoice. It is clarified that the Buyer may not return the Defective Product unless such return was coordinated and approved by Amiad in advance.
6. Amiad's obligation under this Warranty shall be limited to, at Amiad's option, the repair or exchange, free of charge, of the product or any part which may prove defective under normal use and service during the Warranty Period. The provision of a repair or replacement of a product during the Warranty Period will result in an extension of the Warranty Period by an additional period of 12 months, provided that the total accumulated Warranty Period shall in any event be no more than 18 months from the date upon which the products were delivered.
7. This Warranty is valid on the condition that the products are installed according to Amiad's instructions as expressed in Amiad's instruction manuals and according to the technical limitations as stipulated in Amiad's literature or as stated by a representative of Amiad.
8. This Warranty will not apply to damaged or defective products resulting from or related to:
 - (i) Fire, flood, power surges or failures or any other catastrophe and/or unforeseen occurrence, such as but not limited to those for which the Buyer is customarily insured for, or any force majeure events;
 - (ii) Fault, abuse or negligence of the Buyer;
 - (iii) Intake water not meeting the agreed standards, as set forth in a written document, approved by Amiad, or improper storage;
 - (iv) Improper or unauthorized use of the product or related parts by the Buyer, including Buyer's failure to operate the product in conformity with the recommendations and instructions of Amiad, as set forth in Amiad's manuals and other written materials, the operation of the product other than by a trained and qualified operator, or improper installation of the product by a third party not authorized by Amiad;
 - (v) Performance by the Buyer of maintenance or operation other than in conformity with the recommendations and instructions of Amiad, or other than in accordance with procedures defined in the literature supplied for products (including the timely replacement of requisite parts), and for services provided other than by a trained and qualified advanced operator; or
 - (vi) Any alteration, modification, foreign attachment to or repair of the products, other than by Amiad or its authorized technical representatives.
9. In no event shall Amiad be liable to the Buyer or any third party for any damages to property, or for any intangible or economic loss, including loss of profits, loss of customers or damage to reputation, for any damages, including indirect, special, consequential damages, or punitive damage arising out of or in connection with this Warranty, or arising out of or in connection with the product's performance or failure to perform, even if it has been advised of the possibility of such damages.
10. Amiad will be excused for failure to perform or for delay in performance hereunder if such failure or delay is due to causes beyond its reasonable control or force majeure preventing or hindering performance.
11. This Warranty set forth herein is the only contractual warranty given by Amiad and is provided in lieu of any other warranties created by any documentation, packaging or otherwise.
12. Amiad makes no warranty whatsoever in respect to accessories or parts not supplied by Amiad. In the event that Amiad is required to correct a Defective Product or product not covered by this Warranty, it will do so solely in consideration for additional fees.
13. The parties will actively endeavor to amicably settle any dispute arising between them. In the event that the parties are unable to reach an equitable settlement of such dispute, any claim or lawsuit related to the Warranty, its validity execution, its performance be brought before only the courts of Tel-Aviv, Israel. Israeli law will govern the Warranty, to the exclusion of any conflict of law rules.



Headquarters: 54/18 Bui Quang La, Ward 12, Go Vap District, HCMC, Viet Nam
Office: 12 DHT10B, Dong Hung Thuan Ward, District 12, HCMC, Viet Nam
Phone: (028) 6258 5368 - (028) 6291 9568
Email: info@atswatertechnology.com
Website: www.atswatertechnology.com



Amiad Water Systems Ltd. D.N. Galil Elyon 1, 1233500, Israel.

Tel: +972 4690 9500 | Fax: +972 48141159 | Email: info@amiad.com

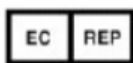

Obelis s.a. Bd Général Wahis 53, 1030 Brussels, Belgium.

Tel: +(32) 2732 5954 | Fax: +(32) 27326003 | Email: mail@obelis.net

EC Declaration http://amiad.com/pdf/certificates/MACHINERY_SAFETY.pdf