



4" Spin Klin™ Galaxy

Automatic disc
filtration system

MAST FILTRA



**Your water
challenge.
Our filtration
solution.**

Amiad Water Systems is a world leader in water treatment and filtration solutions. For over 57 years Amiad has devoted its passion and commitment to developing a comprehensive line of water filtration systems for a wide range of industrial applications.

Our solutions are integrated into the core of water filtration systems in the following industries and applications: metal, plastic, energy, chemical, water treatment and salt water disposal.

MASTERS OF FILTRATION



Any Technology







Any Water Source



We develop filters that are able to cope with any water quality, in any geographical location.

We've spent years mastering filtration technology so we can offer a wide range of filters for every industrial need, including screen, disc, microfiber or media technology.

- 
Disc Technology
- 
Screen Technology
- 
Media Technology
- 
Microfiber Technology

We consider every challenge as an opportunity to work side by side with our customers to solve their problems.

We'll go anywhere to ensure our filters perform as expected, 24/7, every day of the year.

When you want a high-performance solution for your water filtration system, consult with Amiad. We focus on doing what we do best.

Amiad. Masters of Filtration.

4" SPIN KLIN™ Galaxy: Modular Depth Filtration

SPIN KLIN™ GALAXY FEATURES

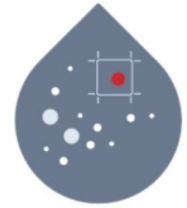

Micron-precise depth
filtration of solids



Polymeric

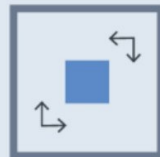

Compact design



Low water and energy
consumption



Minimal maintenance





Reliable and durable



Scan to watch the
Spin Klin™ Operation
Video

4" SPIN KLIN™ Galaxy: Modular Depth Filtration

4" Spin Klin™ Galaxy Spine Technology



Galaxy pod

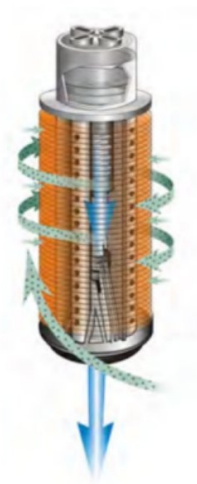

Filtration mode

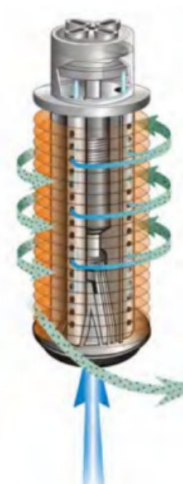

Backwash mode

Disc material type availability according to filtration degree:

10	20	40	55	70	100	130	200	400
PP	PP, PA	PP, PA	PP, PA	PP, PA	PP, PA	PP, PA	PP, PA	PP

PP = Polypropylene disc PA = Nylon disc



4" Spin Klin™ Galaxy Battery Installation



Construction materials	
Filter housing & lid	PP (Polypropylene)
Disc elements	PP (Polypropylene) or PA (Polyamide)
Backwash valves	RPA (Reinforce Polyamide)
Manifolds	PP (Polypropylene)
Seals	NBR or EPDM, (Viton optional)
Control tubing	PE or PA

4" SPIN KLIN™ Galaxy: Models

4" Spin Klin™ Galaxy



Head Loss Graphs (in clean water)

3 x 4" Spin Klin™ Galaxy Battery

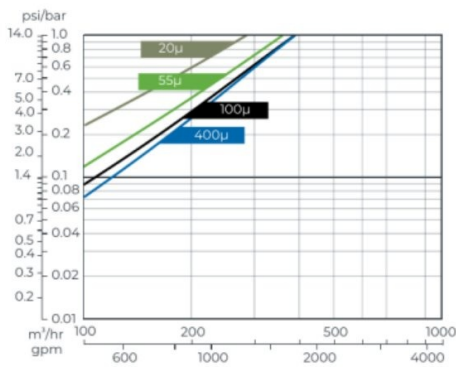

4 x 4" Spin Klin™ Galaxy Battery

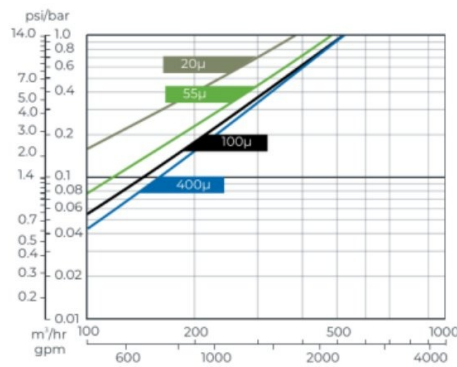

5 x 4" Spin Klin™ Galaxy Battery

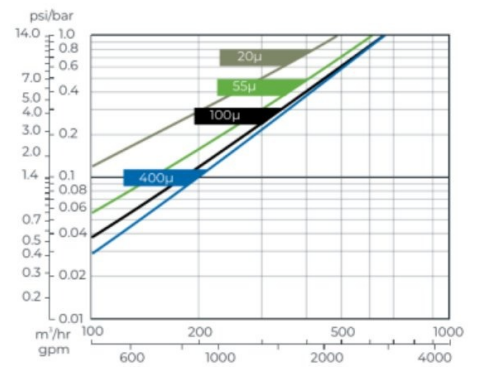

6 x 4" Spin Klin™ Galaxy Battery

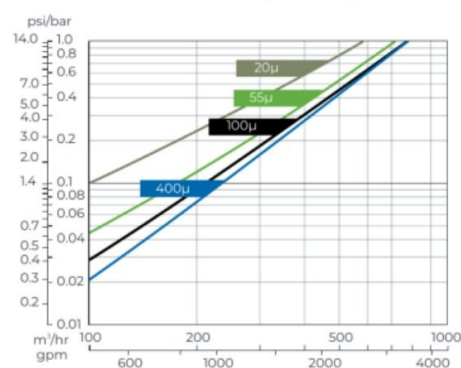

7 x 4" Spin Klin™ Galaxy Battery

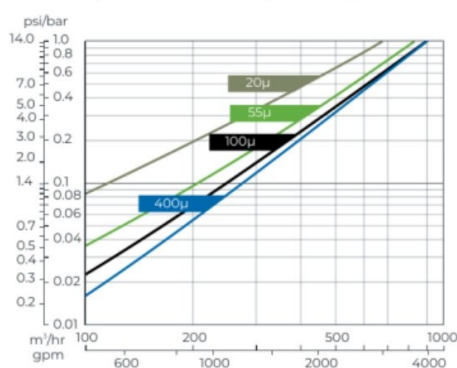

8 x 4" Spin Klin™ Galaxy Battery

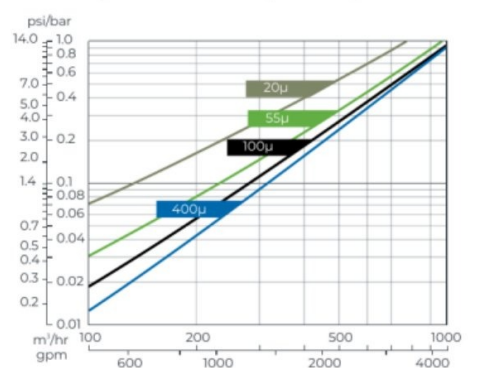



Filter Type	3 unit battery	4 unit battery	5 unit battery	6 unit battery	7 unit battery	8 unit battery
-------------	----------------	----------------	----------------	----------------	----------------	----------------

General Data

Max. operating pressure*		10 bar (145 psi)					
Min. backwash pressure	400-100μ	2.8 bar (40 psi)					
	55-20μ	4-5 bar (58 - 72 psi)					
Max. recommended flow rate	100μ	225 m ³ /h (990 gpm)	300 m ³ /h (1,320 gpm)	375 m ³ /h (1,650 gpm)	450 m ³ /h (1,980 gpm)	525 m ³ /h (2,310 gpm)	600 m ³ /h (2,642 gpm)
	55μ	150 m ³ /h (660 gpm)	200 m ³ /h (880 gpm)	250 m ³ /h (1,101 gpm)	300 m ³ /h (1,321 gpm)	350 m ³ /h (1,541 gpm)	400 m ³ /h (1,761 gpm)
	20μ	75 m ³ /h (330 gpm)	100 m ³ /h (440 gpm)	125 m ³ /h (550 gpm)	150 m ³ /h (660 gpm)	175 m ³ /h (770 gpm)	225 m ³ /h (990 gpm)
Available filtration degrees		400, 200, 130, 100, 70, 55, 40, 20, 10 micron					
Filtration volume		17,219 cm ³ (1,051 in ³)	22,959 cm ³ (1,401 in ³)	28,698 cm ³ (1,751 in ³)	34,438 cm ³ (2,101 in ³)	40,177 cm ³ (2,451 in ³)	45,918 cm ³ (2,802 in ³)
Inlet/outlet diameter		200 mm (8")	280 mm (10")		315 mm (12")		355 mm (14")
Max. working temperature*		60°C (140°F)					
Dry weight standard		270 kg (594 lb)	350 kg (770 lb)	440 kg (968 lb)	530 kg (1,166 lb)	670 kg (1,447 lb)	770 kg (1,694 lb)

*Maximum operating pressure and temperature are interdependent parameters and are given for general reference only. Please consult your authorized Amiad representative for the application specific parameters.

Backwash Data

Drain connection	110 mm (4")
Flushing time	20 seconds
Min. flow for backwash	50 m ³ /h (220 gpm)

Typical Installation Drawing

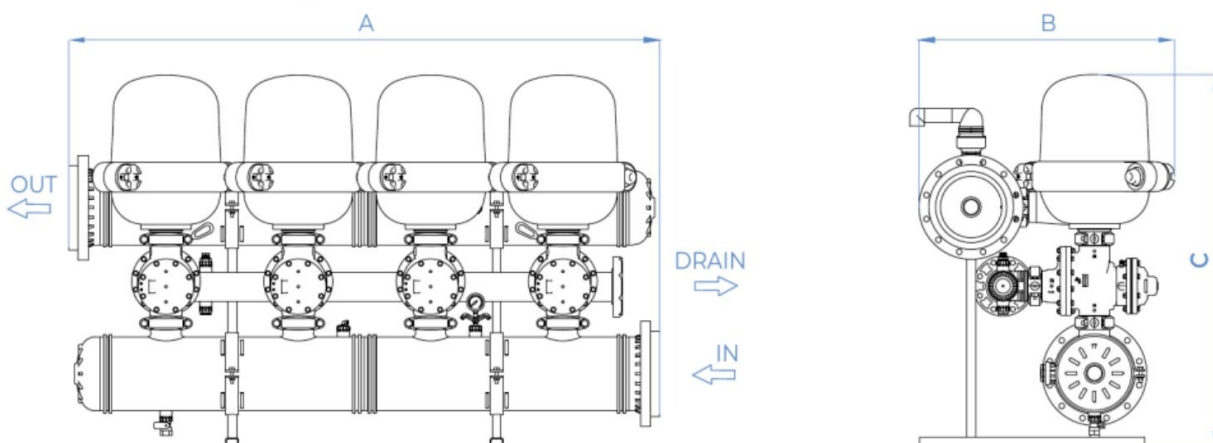

Dimensions		3 unit battery	4 unit battery	5 unit battery	6 unit battery	7 unit battery	8 unit battery
A	Length	1,664 mm (65 1/2")	2,234 mm (87 15/16")	2,734 mm (107 5/8")	3,234 mm (127 5/16")	3,734 mm (147")	4,234 mm (166 11/16")
B	Width	940 - 980 mm (35 7/16" - 38 9/16")					
C	Height	1,370 mm (53 15/16")		1,408 mm (55 7/16")		1,466 mm (57 23/32")	

4" SPIN KLIN™ Galaxy: Models

4" Spin Klin™ Galaxy External Source



Head Loss Graphs (in clean water)

3 x 4" Spin Klin™ Galaxy
Battery External Source

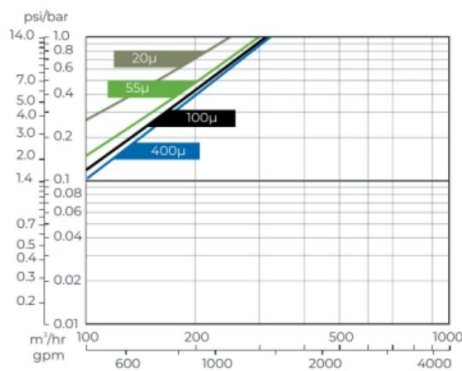

4 x 4" Spin Klin™ Galaxy
Battery External Source

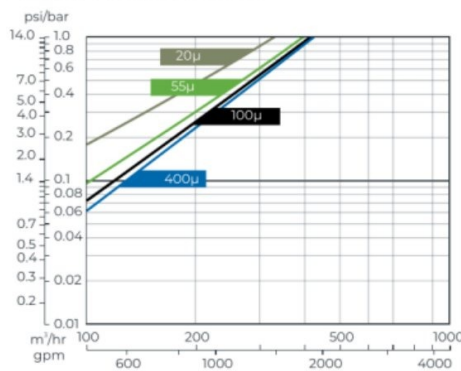

5 x 4" Spin Klin™ Galaxy
Battery External Source

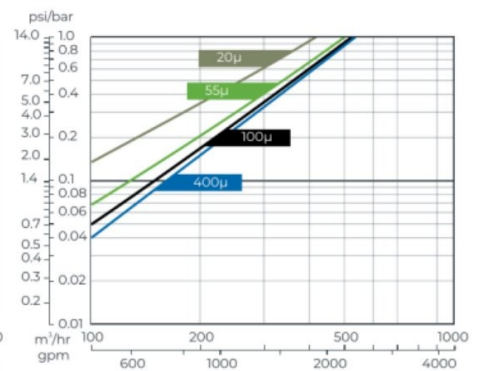

6 x 4" Spin Klin™ Galaxy
Battery External Source

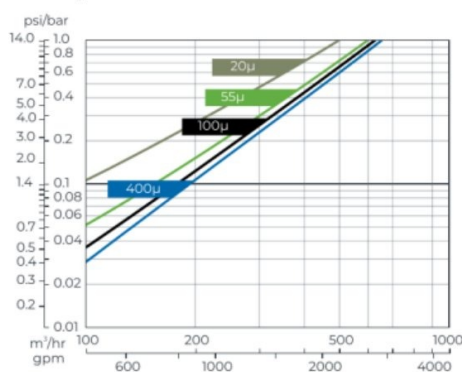

7 x 4" Spin Klin™ Galaxy
Battery External Source

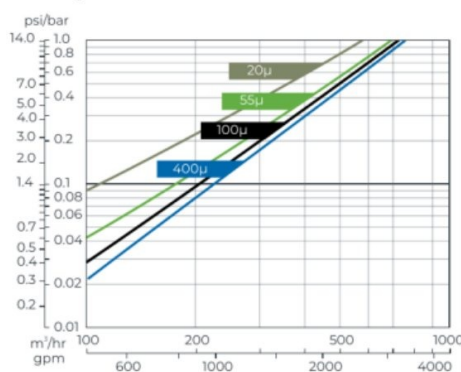

8 x 4" Spin Klin™ Galaxy
Battery External Source

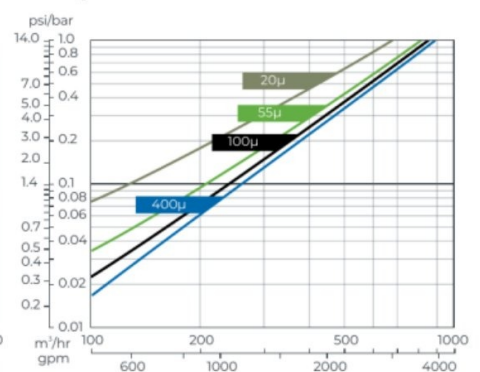

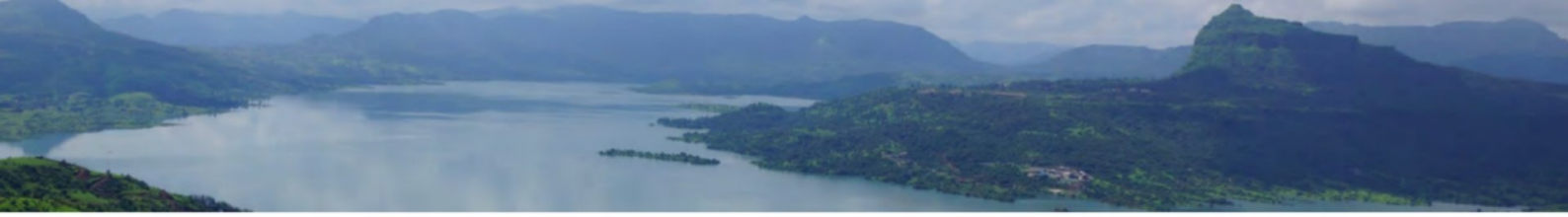

Filter Type	3 unit battery	4 unit battery	5 unit battery	6 unit battery	7 unit battery	8 unit battery
-------------	----------------	----------------	----------------	----------------	----------------	----------------

General Data

Max. operating pressure*	10 bar (145 psi)						
Min. backwash pressure	400-100µ	2.8 bar (40 psi)					
	55-20µ	4-5 bar (58 - 72 psi)					
Max. recommended flow rate	100µ	225 m ³ /h (990 gpm)	300 m ³ /h (1,320 gpm)	375 m ³ /h (1,650 gpm)	450 m ³ /h (1,980 gpm)	525 m ³ /h (2,310 gpm)	600 m ³ /h (2,642 gpm)
	55µ	150 m ³ /h (660 gpm)	200 m ³ /h (880 gpm)	250 m ³ /h (1,101 gpm)	300 m ³ /h (1,321 gpm)	350 m ³ /h (1,541 gpm)	400 m ³ /h (1,761 gpm)
	20µ	75 m ³ /h (330 gpm)	100 m ³ /h (440 gpm)	125 m ³ /h (550 gpm)	150 m ³ /h (660 gpm)	175 m ³ /h (770 gpm)	225 m ³ /h (990 gpm)
Available filtration degrees	400, 200, 130, 100, 70, 55, 40, 20, 10 micron						
Filtration volume	17,219 cm ³ (1,051 in ³)	22,959 cm ³ (1,401 in ³)	28,698 cm ³ (1,751 in ³)	34,438 cm ³ (2,101 in ³)	40,177 cm ³ (2,451 in ³)	45,918 cm ³ (2,802 in ³)	
Inlet/outlet diameter	200 mm (8")	280 mm (10")		315 mm (12")		355 mm (14")	
Max. working temperature*	60°C (140°F)						
Dry weight external source backwash	340 kg (748 lb)	440 kg (968 lb)	550 kg (1,210 lb)	650 kg (1,430 lb)	810 kg (1,782 lb)	920 kg (2,024 lb)	

*Maximum operating pressure and temperature are interdependent parameters and are given for general reference only. Please consult your authorized Amiad representative for the application specific parameters.

Backwash Data

Drain connection	110 mm (4")
Flushing time	20 seconds
Min. flow for backwash	50 m ³ /h (220 gpm)

Typical Installation Drawing

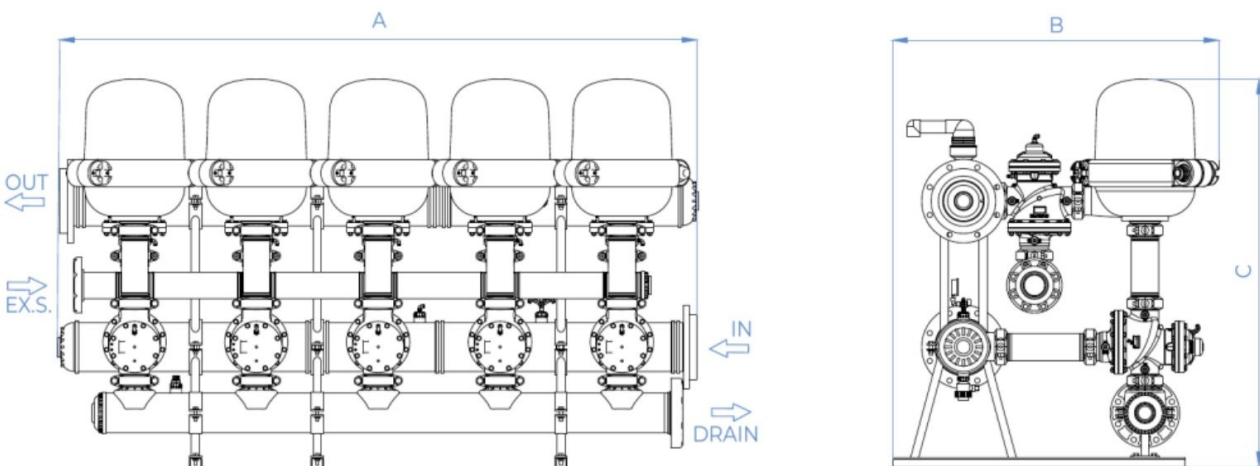

Dimensions		3 unit battery	4 unit battery	5 unit battery	6 unit battery	7 unit battery	8 unit battery
A	Length	1,664 mm (65 1/2")	2,234 mm (87 15/16")	2,734mm (107 5/8")	3,234 mm (127 5/16")	3,734 mm (147")	4,234 mm (166 11/16")
B	Width	1,352 mm (53 7/32")					
C	Height	1,590 mm (62 19/32")					

Note: All dimensions are for reference only. Certified drawings are available upon request.



Headquarters

Amiad Water Systems Ltd.

Web: www.amiad.com

E-mail: info@amiad.com



**ATS WATER
TECHNOLOGY**

Headquarters: 54/18 Bui Quang La, Ward 12, Go Vap District, HCMC, Viet Nam

Office: 12 DHT10B, Dong Hung Thuan Ward, District 12, HCMC, Viet Nam

Phone: (028) 6258 5368 - (028) 6291 9568

Email: info@atswatertechnology.com

Website: www.atswatertechnology.com

The Americas

USA

Amiad USA Inc.

Web: us.amiad.com | E-mail: infousa@amiad.com

Mexico

Amiad México SA DE CV,

Web: es.amiad.com | E-mail: infomexico@amiad.com

Asia

India

Amiad Filtration India Pvt Limited

Web: amiad.com | E-mail: info-india@amiad.com

China

Amiad China (Yixing Taixing Environtec Co., Ltd.)

Web: cn.amiad.com | E-mail: infochina@amiad.com

South-East Asia

Filtration & Control Systems Pte. Ltd.

Web: amiad.com | E-mail: info-singapore@amiad.com

Australia

Amiad Australia Pty Ltd.

Web: au.amiad.com | E-mail: sales@amiad.com

Europe

Amiad Water Systems Europe SAS

Web: amiad.com | E-mail: industry-europe@amiad.com

German branch office

Web: de.amiad.com | E-mail: industry-de@amiad.com

United Kingdom

Amiad Water Systems UK Limited

Web: amiad.com | E-mail: info-uk@amiad.com



 **amiad** INDUSTRY

MASTERS OF FILTRATION

www.amiad.com

910101-000565/01.2023

Copyright © 2019 Amiad Water Systems Ltd. All rights reserved. The contents of this catalogue including without limitation all information and materials, images, illustrations, designs, icons, photographs, graphical presentations, designs, literary works, data, drawings, slogans, phrases, names, trademarks, titles and any other such materials that appear in this catalogue (collectively, the "Contents") are the sole property of Amiad Water Systems Ltd. ("Amiad"). Amiad has sole and exclusive right, title and interest in the Contents, including any intellectual property rights, whether registered or not, and all know-how contained or embodied therein. You may not reproduce, publish, transmit, distribute, display, modify, create derivative works from, sell or participate in any sale of, or exploit in any way, in whole or in part, any of the Contents or the catalogue. Any use of the catalogue or the Contents, other than for personal use, requires the advanced written permission of Amiad.