

# Amiad Water Systems

## AMF-36K Micro-fiber Filter With Graphical HMI User Guide

Serial number: \_\_\_\_\_

Order number: \_\_\_\_\_

Catalog number: \_\_\_\_\_

Filtration degree: \_\_\_\_\_

Tested by: \_\_\_\_\_

## Installation and Operation Instructions

Original Instructions - Ref. 910101-000592 08.2013

## Amiad Water Systems

### AMF-36K Micro-fiber Filter With Graphical HMI User Guide

This manual is the operation manual of Amiad's AMF 36K filter; it describes the installation and the commissioning processes for a single filter installation and specifies the end-user operation procedures.

For broadening the end-user's knowledge a general description of Amiad's micro-fiber filtration technology is also provided.



**Disclaimer:**

This document and the information enclosed within it contain restricted and/or privileged information that are intended only for usage by authorized Amiad technicians. If you are not a qualified Amiad technician you must not take any action in reliance to this document, unless permitted by Amiad.

None of the procedures provided on this file may be used in any form or by any means without permission from Amiad.

If you received this file in error please notify Amiad immediately. (reuve@amiad.com)

The confidential nature of and/or privilege in the file enclosed is not waived or lost as a result of a mistake or error in this file.

Amiad accepts no liability whatsoever, whether it was caused by:

1. Accessing or other related actions to this file.
2. Any links, procedures or materials provided/attached to this file.

Amiad assumes that all users understand risks involved within this file and/or its attached materials.

All the procedures, drawings, pictures and/or any other information provided in this document are presented as general information only; they can be altered, removed or changed without any further notice by Amiad.

This document does not replace any certified drawing, procedure or information provided by Amiad in reference to a specific customer, site or project.

All rights reserved.

## TABLE OF CONTENTS

1. Introduction & How to use this manual .....	Page 4
1.1 Using this manual	
1.2 Safety instructions	
1.2.1 General	
1.2.2 Installation	
1.2.3 Operation, Control and Maintenance	
1.2.4 Use of Lifting Equipment	
1.2.5 Notes	
1.3 General description of the micro-fiber filtration technology	
1.3.1 Filter media	
1.3.2 Filtration process	
1.3.3 The cleaning sequence	
2. Installation .....	Page 13
2.1 Pre-installation requirements	
2.1.1 Floor area and surface	
2.1.2 Power supply	
2.1.3 Water supply for filter flushing	
2.1.4 Drainage system	
2.1.5 Compressed air supply	
2.1.6 Filter tune-up tool	
2.2 The Installation Process	
2.2.1 Positioning the filter	
2.2.2 Pipeline connections	
2.2.3 Post shipment inspection	
2.2.4 Power Supply– Electricity and Pneumatics	
3. Description of the control panel .....	Page 29
3.1 Introduction	
3.2 Components mounted on the control panel door	
3.3 Internal components of the control panel	
3.4 Basic operation of the PLC	
4. Start-up and First Operation .....	Page 54
4.1 Dry stage – Connections verification	
4.2 Wet stage A. – Initial flushing cycle	
4.3 Wet stage B. – First filtration cycle	
5. Technical specifications .....	Page 62
5.1 Standard AMF 36K Specifications	
5.2 Solenoids' drawing	
5.3 Control cabinet drawings	

## **1. Introduction & How to use this manual**

### **1.1 Using this manual**

This manual describes the end-user operation procedures of Amiad's AMF 36K filter. For broadening the user's general knowledge a general description of Amiad's micro-fiber filtration technology and some basic information on installation is also provided.

This manual does not replace the Technicians' Installation, Service and Maintenance Manuals and it should not be used for any task other than the regular operation of the filter.

Before operating the filter please read this manual carefully. Make sure that:

- You are familiar with the safety instructions (Chapter 1.2)
- You understand the basics of the Micro-fiber filtration technology (Chapter 1.3)
- You know how to use the control panel (Chapter 3)

### **1.2 Safety instructions**

#### **General Safety Instructions**

- Amiad filtration products always operate as components in a larger system. It is essential for the system designers, installers and operators to comply with all the relevant safety standards.
- Prior to installation, operation, maintenance or any other type of action carried out on the filter, read carefully the safety, installation and operation instructions.
- During installation, operation or maintenance of the filter all conventional safety instructions should be observed in order to avoid danger to the workers, the public or to property in the vicinity.
- Please note: The filter enters into a flushing mode automatically, without prior warning.
- No change or modification to the equipment is permitted without a written notification given in advance by the manufacturer or by its representative, on the manufacturer's behalf.
- Always observe standard safety instructions and good engineering practices whilst working in the filter's vicinity.
- Use the filter only for its intended use as designed by Amiad, any misuse of the filter may lead to undesired damage and may affect your warranty coverage. Please consult with Amiad prior to any non-regular use of this equipment.

#### **Installation**

##### **General**

- Install the filter according to the detailed Installation Instructions provided with the filter by the manufacturer and according to the description given in this manual.
- Make sure to leave enough clearance so as to enable easy access for future treatments and safe maintenance operations.
- The user should arrange suitable lighting at the area of the filter to enable good visibility and safe maintenance.
- The user should arrange suitable platforms, ladders and safety barriers to enable easy and safe access to the filter without climbing on pipes and other equipment. The user should verify that any platform, barrier, ladder or other such equipment is built, installed and used in accordance with the relevant local authorized standards.
- Check and re-tighten all bolts during commissioning and after the first week of operation.

- Use only appropriate standard tools and equipment operated by qualified operators when installing, operating and maintaining the filter.
- When installation is required in hazardous environment sites, underground or high above ground, make sure that the site design and the auxiliary equipment are appropriate and that installation procedures are carried out in accordance with the relevant standards and regulations.
- Ensure walking areas about the installation are slip free when wet.

#### Shipment and transporting

- Shipping and transporting the filter must be done in a safe and stable manner and in accordance with the relevant standards and regulations.
- For shipping, lifting and positioning the filter, use only approved lifting equipment and authorized employees and contractors.

#### Electricity

- Electric wiring should be performed by an authorized electrician only, using standardized and approved components.
- Install a **lockable** main power cut-off switch close to the control panel.
- If due to site constraints, the control panel is installed without a clear line-of sight of the filter, an additional **lockable** power disconnect cut-off switch should be installed near each filter unit.
- Installation of the filter should be performed so as to avoid direct water splashing on the electrical components or on the control panel.

#### Pneumatics

- Install a **lockable** main cut-off switch, **featured with a pressure release mechanism**, on the compressed air supply line close to the control panel.
- If the control panel is installed far away and there is no eye contact with the filter, a **lockable** compressed air cut-off switch, **featured with a pressure release mechanism**, should be installed near each filter unit.
- The user should make sure that the compressed air supplied to the filter never exceeds the maximum designated pressure for this filter. An air-pressure reduction valve should be installed on the compressed air supply line upstream of the filter's pneumatic inlet port.

#### Hydraulics

- Extra safety devices should be installed on hot water applications to avoid skin burn danger.
- The user should install a manual Water Cut-off Valve next to the filter's inlet port.
- In cases where the downstream piping network downstream of the filter is pressurized an additional manual Water Cut-off Valve should be installed next to the filter outlet port.
- The user should make sure that the system includes a Pressure Release / Drainage Valve to enable release of residual pressure prior to any maintenance procedure performed on the filter.
- The user should make sure that the filter is never exposed to water pressure exceeding the maximum designated pressure for this filter, if needed a Pressure Reduction Valve should be installed upstream of the filter's water inlet port.
- Please note that the maximum working pressure indicated at the filter's specifications table includes the pressure caused by fluid hammer and pressure surge effects.

### **Civil Engineering**

- Make sure that the filter installation is done by Amiad qualified technicians.
- Make sure that any civil engineering work at the installation site such as construction, lifting, welding, etc. is done by qualified workers / technicians / contractors and in accordance with the relevant local standards.
- While using lifting equipment, make sure that the filter or the lifted part is chained securely and in a safe manner.
- Do not leave lifted equipment if there is no necessity. Avoid working below lifted equipment.
- Wear a safety helmet while using lifting equipment.
- Make sure that the flooring is sloped for drainage and to avoid accumulation of liquids.

### **Commissioning**

- Read carefully the Commissioning and the First Start-up Operation instructions prior to any attempt to operate the filter.
- In order to achieve maximum performance and smooth operation of the filter it is crucial to perform the Startup and First Operation procedures exactly as described in this manual.
- Commissioning the filter should be done by an authorized Amiad technician, do not attempt to commission the filter unaccompanied since this may lead to undesired damage and may affect your warranty coverage.

### **Operation and Control**

- Do not operate the filter before reading carefully and being familiar with its operation instructions.
- Observe the safety stickers on the filter and never perform any operation contradicting the instructions given.
- Never operate or use the filter for purposes other than its original design and operational envelope.

### **Maintenance**

#### **Before any maintenance or non-regular operation please read the following:**

- Servicing the filter should be done only by technicians authorized by Amiad.
- Disconnect the filter from the power supply and lock the Main Power Switch.
- Disconnect the compressed air supply, release the residual pressure and lock the Pneumatics Main Valve.
- Disconnect the filter from the water system by closing and securing the Manual Inlet Valve. In cases where the downstream piping network is pressurized, close and secure the Manual Outlet Valve also.
- Release the residual water pressure by opening the Pressure Release / Drainage Valve.
- Empty the filter by opening the Drainage Valve.
- In hot water systems wait till the filter components cool off to a safe temperature.
- Place warning signs around the work area as required by the local standards and procedures.
- Inspect the filter's safety stickers and replace any damaged or faded sticker.

#### **Mechanical**

- When working on the filter use only appropriate standard tools.
- Always open and close valves slowly and gradually.
- Remove grease and fat material residues in order to avoid slipping.

- Before disconnecting the filter from the water supply, electricity and pneumatics and before releasing the filter's residual pressure do NOT:
  - loosen or unscrew bolts
  - remove any protection cover
  - open any service port flange
- Avoid splashing and water leakage so as to minimize slippage, electrification or damage to the equipment, caused by moisture.
- While using lifting equipment, make sure that the filter or the lifted part is chained securely and in a safe manner.
- Do not leave lifted equipment if there is no necessity. Avoid working below lifted equipment.
- Wear a safety helmet, goggles, gloves, and any other personal safety equipment required by the local standards and regulations.
- Human entry into a filter must be done in accordance with the relevant local safety instructions, standards and regulations for working in hazardous environment.
- Manual cleaning of filter media using high water pressure or steam should be performed in accordance with the cleaning system instructions, the local standards and regulations and without endangering the operator or the vicinity
- Manual cleaning of filter element using acid or other chemical agents should be performed in accordance with the relevant material safety instructions, the local standards and regulations and without endangering the operator or his vicinity.

#### **Before returning to regular operation**

- Re-assemble any protection covers or protection mechanisms removed during service or maintenance operations.
- Make sure that all the tools, ladders, lifting devices, etc. used during the maintenance procedures are taken away from the filter area and stored
- In order to return the filter to regular operation, follow the First Start-up Operation instructions as detailed in your user manual.
- For filters used in potable water systems it is required to disinfect the filter according to the local water authority standards and regulations before putting it back to service.

### 1.3 General description of the micro-fiber filtration technology

Textile fibers are widely used for fine filtration in the disposable cartridge filter market. Amiad Filtration Systems developed an innovative self-cleaning micro-fiber filtration technology and implemented it on a wide range of automatic filters. For the end-user general knowledge the following paragraph describes the basics of this technology.

**Please note:**

**Each model of Amiad’s micro-fiber filters has a different size, flow-rate and number of cartridges, therefore the drawings and pictures used in this description do not necessarily reflect the actual layout and components of your actual filter, they are provided for explaining the technology only.**

#### 1.3.1 Filter Media

Amiad AMF filter is based on Amiad’s automated micro-fiber technology. The basic component of this filtration technology is the Cassette which is a filter media consists of a grooved rigid plastic plate over which multi layer textile threads have been wound (Fig1). The thread type and tension together with the number of layers define the filtration degree from twenty down to two microns.

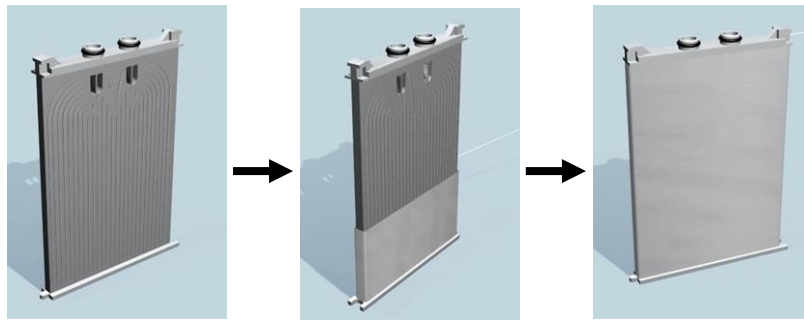

Figure 1

35 cassettes connected to a joined-in collector pipe unit form a package. 26 packages attached to each other form a cartridge (Fig2) which is installed in the filter housing (Fig3).

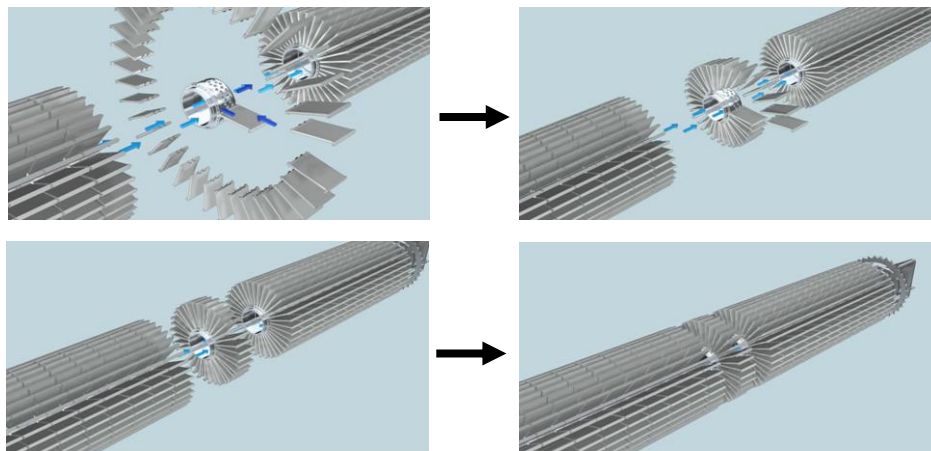

Figure 2



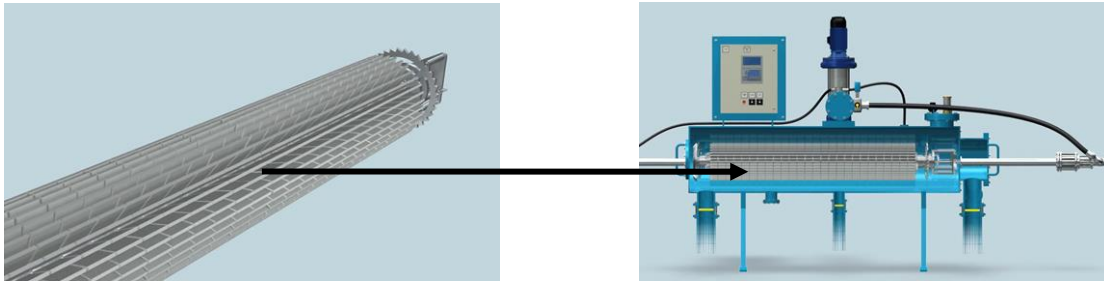

Figure 3

1.3.2 Filtration Process

The contaminated liquid flows from the inlet control valve, through the threads, into the grooves and through the nipples to the collector pipe, flowing to the clean liquid chamber and, through the outlet control valve, to the customer's system (Fig4+5).

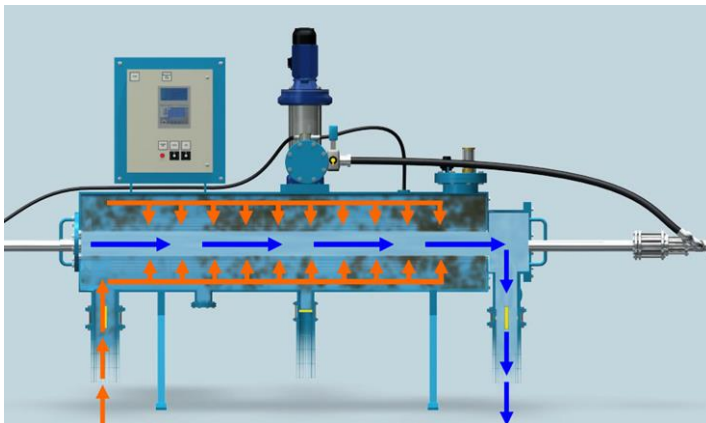

Figure 4

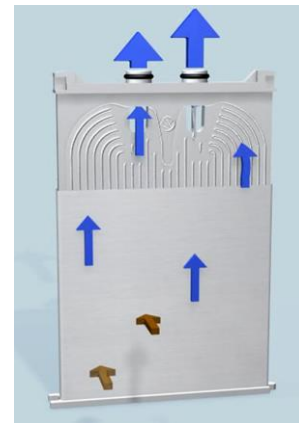

Figure 5

Larger dirt particles are stopped on the surface of the multiple layers of thread (Fig6) and form a filter cake. Finer particles that penetrate the surface are trapped deep inside the thread layers (Fig7). As dirt is stopped the filter differential pressure gradually increases.



Figure 6

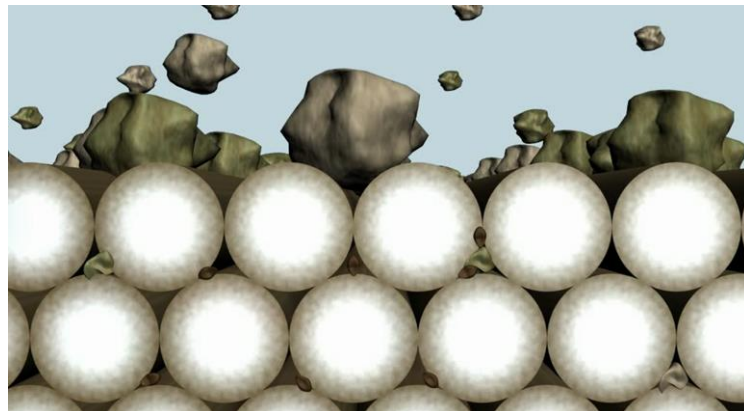

Figure 7

### 1.3.3 The cleaning sequence

The control system activates the self cleaning sequence at a preset pressure differential level or by a preset timer, whichever comes first (Fig8).

The cleaning sequence starts with the control unit starting the flushing pump (Fig9), which boosts into the system highly pressurized clean water. The inlet and outlet valves are then closed isolating the filter from the main line. A few seconds later, the drain valve opens, emptying the filter (Fig10).



Figure 8



Figure 9



Figure 10

The highly pressurized water enters the filter through the flushing control valve, into a shuttle pipe fitted with a movable spray unit (Fig11). The spray unit (Fig12) moves back & forth along the entire length of one cartridge row, pushed by a piston driven in both directions by boosted water (Fig13).



Figure 11



Figure 12

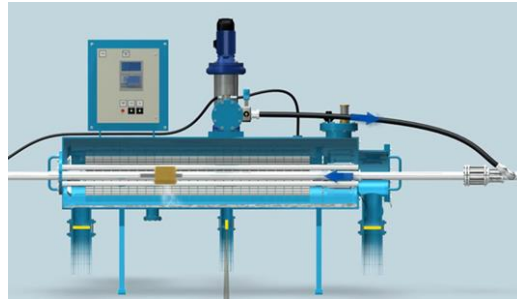

Figure 13

Each spray nozzle creates multiple jet streams; these jets pass through the thread layers of the cassette, hit the plastic wall and are forced backwards. This creates a powerful spot back flush, which carries with it the trapped particles and the filter cake out of the cassettes thread layers and through the open drain control valve to the gravity drain system (Fig14, 15).

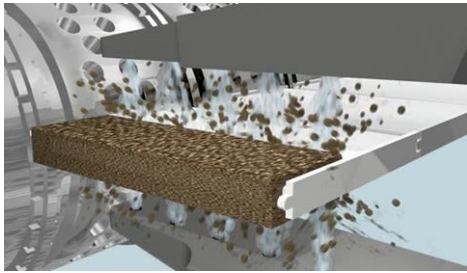

Figure 14

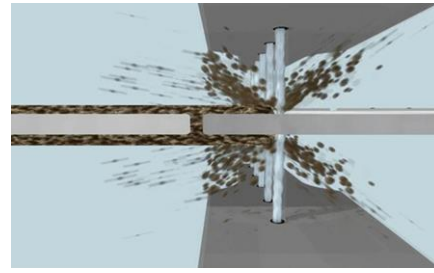

Figure 15

After each row of cassettes is cleaned (Fig16) the nozzle unit slightly changes position, the control unit commands the index assembly to turn the cartridge until the next row is positioned against the nozzle unit (Fig17), ready to start cleaning the new row and so forth (Fig18,19).

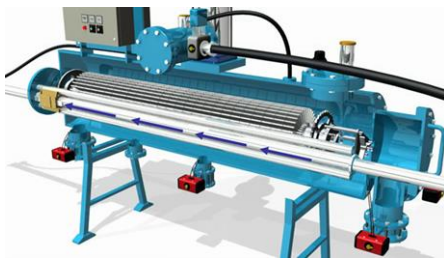

Figure 16

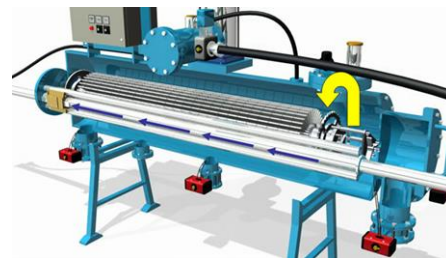

Figure 17

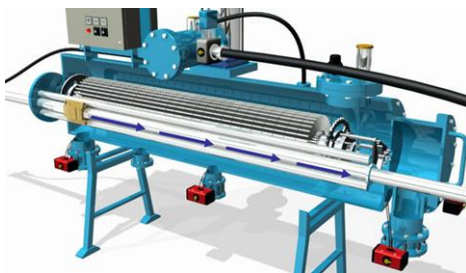

Figure 18

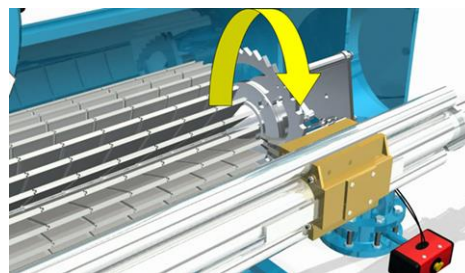

Figure 19

Once the cleaning of all the cassettes is completed, the flush and the drain control valves are closed (Fig20) and the inlet and the "filter to waste" control valves are opened (Fig21).

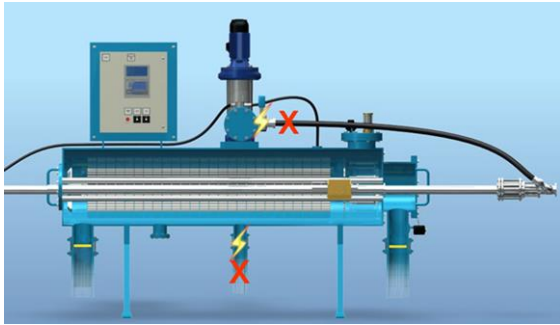

Figure 20



Figure 21

Raw liquid enters the filter and fills it up and initial filtrate is passed through the "filter to waste" control valve (Fig22).

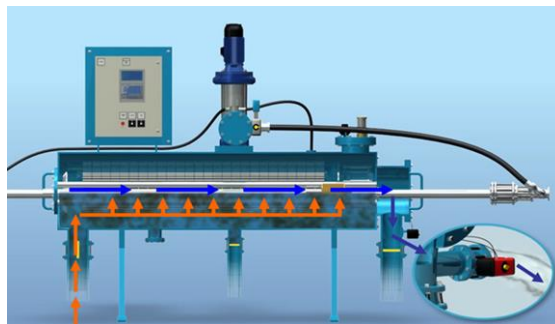

Figure 22

The "filter to waste" control valve closes (Fig23) and afterwards the outlet control valve opens. Finally the flushing pump is turned off (Fig24).

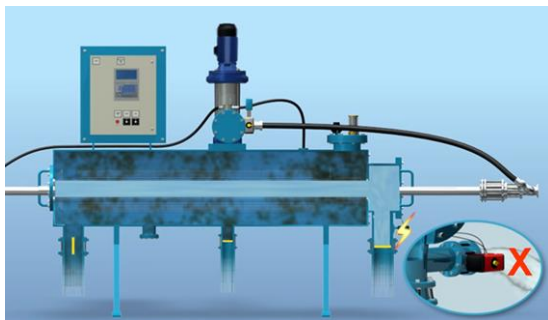

Figure 23



Figure 24

The filter is now back on-line.  
The cleaning cycle takes approximately 10 minutes.

## **2. Installation**

### **2.1 Pre-installation requirements**

Amiad's AMF 36K filter is used for various water filtration applications and therefore can be installed in different types of installation sites; therefore prior to the actual installation of the filter it is important to make sure that the installation site meets the following criteria and requirements:

#### **2.1.1 Floor area and surface**

- The installation site area should be large enough to allow:
  - Access for performing regular maintenance procedures safely
  - Removal of filter components in case that disassembly of the filter is required
  - Installation of additional filter units if expansion of the filtration system is required
  - Installation of platforms and safety barriers to enable easy access to the filter without climbing on pipes and other equipment
- The installation site should be properly drained by providing sufficient floor gradient and preventing standing water accumulation
- The installation site should be properly lighted for good visibility and safe maintenance

#### **2.1.2 Power supply**

- Rated operation voltage - 3 Phase, 220 - 480 V, 50 / 60 Hz. Please consult your Certified General Arrangement Installation drawings for details
- Power consumption – 3 KW
- Power connection to the pump:
- In cases where the pump power supply is not pre connected by the factory, connect the pump to the control panel by means of a cable of 4 x 2.5mm<sup>2</sup> for a distance of up to 10m. Consult Amiad for cable specifications for distances longer than 10m. (In any case the user is responsible that this installation meets or exceeds the local or the national electrical codes; this is a "high" voltage connection).

#### **2.1.3 Water supply for filter flushing**

For proper removal of the filter cake without causing damage to the filter media, it is mandatory for the filter flushing process to use clean filtered water only. Therefore, the filter's flushing pump should be connected to a filtered water source capable of supporting a flow-rate of 6 M<sup>3</sup>/h (27 GPM).

In a single filter installation the flushing water source may be one of the following options:

- In cases where the filter is installed upstream of any type of water storage facility such as reservoir, water tank or water tower, a supply line can be installed between the clean water storage and the filter for feeding the filter's flushing pump with filtered water.
- In cases where the filter is connected directly to the end-users' pipeline, a designated flushing water tank should be installed in the filter vicinity. This tank is connected to the downstream outlet of the filter and is filled-up during the regular operation of the filter in order to serve as the flushing pump's water source during the flushing process. The minimal water storage in such tank should be – 1 M<sup>3</sup> (265 gallon)

#### 2.1.4 Drainage system

- A gravity-flow drainage pipeline should be provided at the installation site.
- It is mandatory that the diameter of the drainage pipeline will be at least at the same size of the filter's original drainage manifold.
- The drainage pipeline should be opened to the atmosphere within the first 0.5 meter fall below the filter housing bottom line.
- No restriction is allowed on the drainage pipe.
- Do not raise the drainage pipeline above the filter housing bottom line.
- It is necessary to prevent vacuum buildup in the filter during the flushing cycles, therefore it is recommended to install a 1.5" vent pipe on the drainage pipeline.
- Make sure that the entire drainage system is flushed and clean before connecting it to the filter.

#### 2.1.5 Compressed air supply

- Dry and lubricated 6-7 BAR (90-105 PSI) standard compressed air supply is needed for the filter operation.
- In case where compressed air supply is not available at the end-user's site, a portable 8 bar / 50 liter compressor should be installed near the filter
- In cases where the user provides the compressed air supply, it is the user's responsibility to install a quick pressure release valve protecting the filter from higher than 8 bar excessive compressed air pressure.

#### 2.1.6 Filter tune-up tool

In order to properly carryout the filter commissioning and the first start-up procedures, a clean and straight 4.5 meter 0.5" pipe (or rod) should be prepared at the installation site. This pipe is needed for pushing one of the filter pistons to its start-up position during the commissioning process.

Note: - For any further information needed for proper designing of the installation site please contact Amiad's Engineering Applications Department.

## 2.2 The Installation Process

### 2.2.1 Positioning the Filter

The filter should be positioned and connected according to its Certified Installation Arrangement Drawing. This drawing specifies the layout of the filtration site as prepared by qualified engineers according to Amiad's Application Engineering Department specifications.

Please study your Certified Installation Arrangement Drawings and then position the filter and mount it to the floor area according to the drawings, please take extra care and exercise the relevant safety instructions.

The following drawing (Fig25) is an example of such Installation Arrangement Drawing. **It does not replace your certified drawing** and it is given here for broadening the end-use knowledge only.

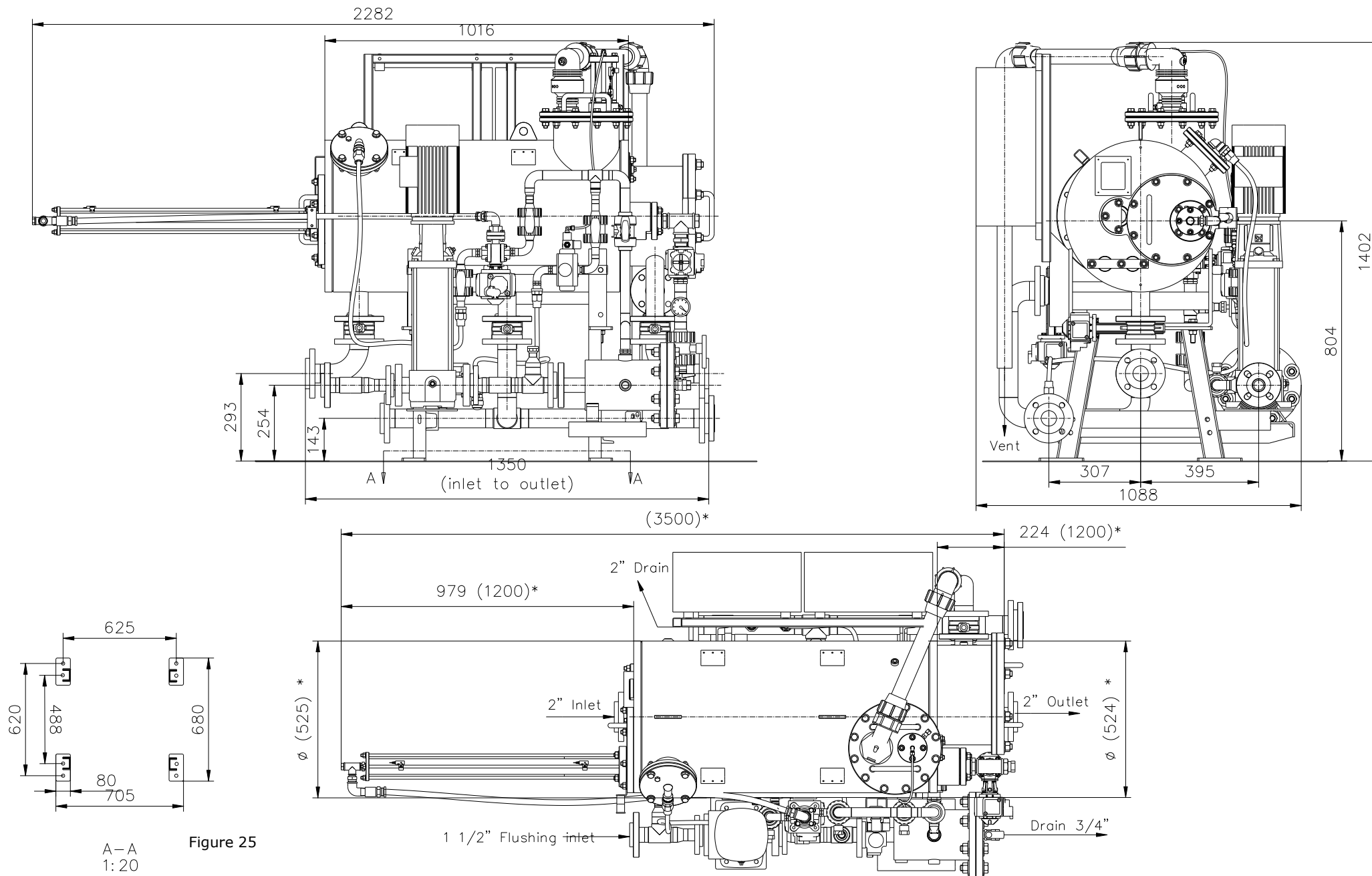
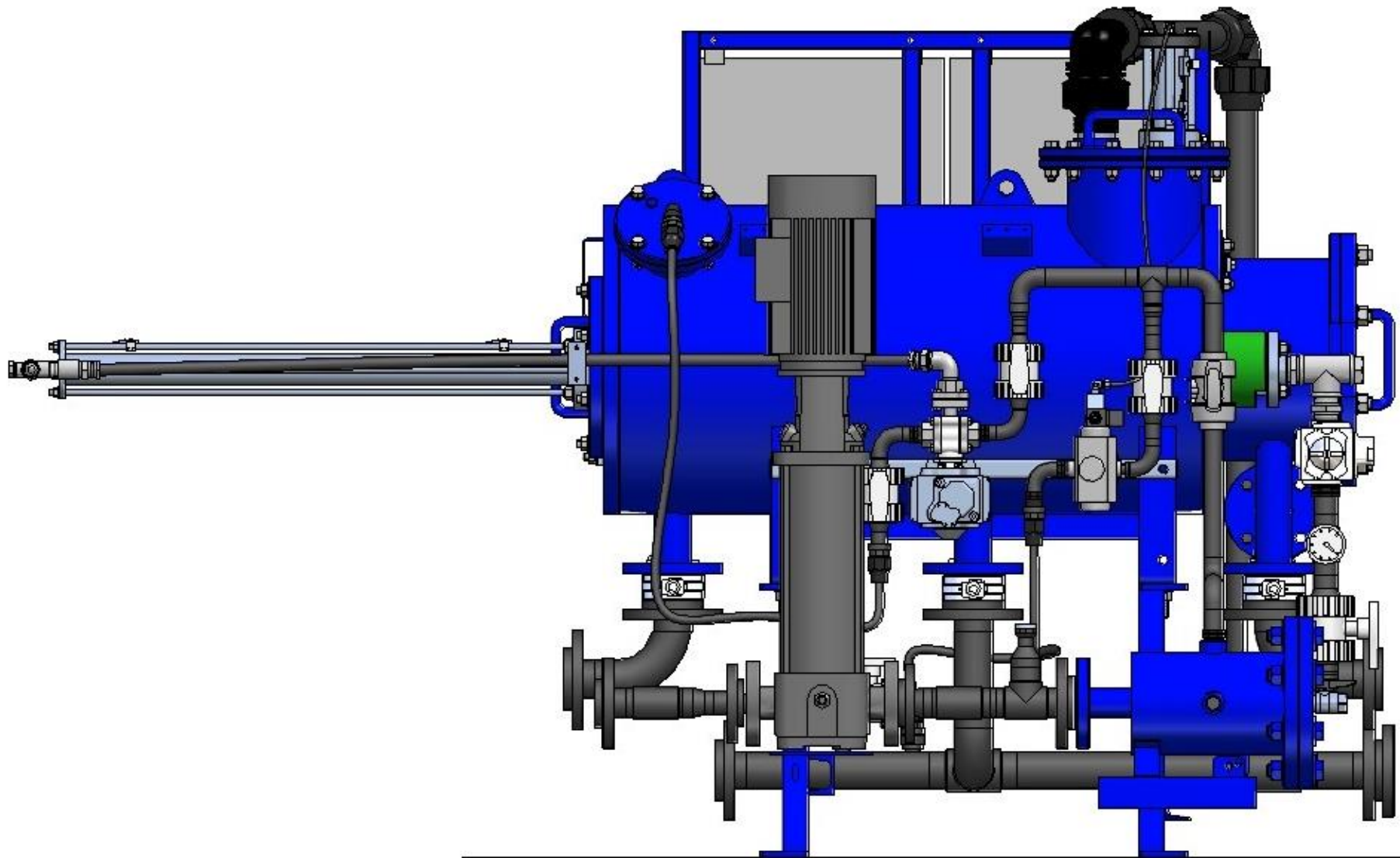

Figure 25

A-A  
1:20





### 2.2.2 Pipeline connections

After the filter is positioned and secured to its designated location consult your Certified Installation Arrangement Drawings and connect the filter to the pipeline network. In general the filter should be connected to the following points:

- Upstream pipe – the entry point of unfiltered water to the filter
- Downstream pipe – the exit point of clean water from the filter and the connection point to the end-user's system
- Drainage system – a manifold exit point for flushed filter cake and “filter to waste” water
- Flushing pump supply – the entry point of clean filtered water to the flushing pump

It is necessary to prevent static backpressure or reverse flow through the filter and therefore it is recommended to install a non-return valve at the outlet of the filter.

It is necessary to protect the filter from excessive line water pressure, therefore the user is required to install a quick pressure release valve to ensure that the filter is not exposed to higher than 10 bar water pressure.

**Note** - Make sure that all pipe connections are bolted and secured properly according to the standards and the good water works practices. **Make sure that the upstream and the downstream valves are kept closed at this stage.**

### 2.2.3 Post shipment inspection

**This task should be done by a competent technician according to the following instructions, do not attempt to commission the filter unaccompanied.**

Before commissioning the filter it is necessary to inspect that no damage had occurred during the shipment and the installation. Please perform the following procedures:

Filter housing inspection for foreign objects and broken components:

1. Disconnect the High Pressure pipe at the far end of the Piston House Assembly.

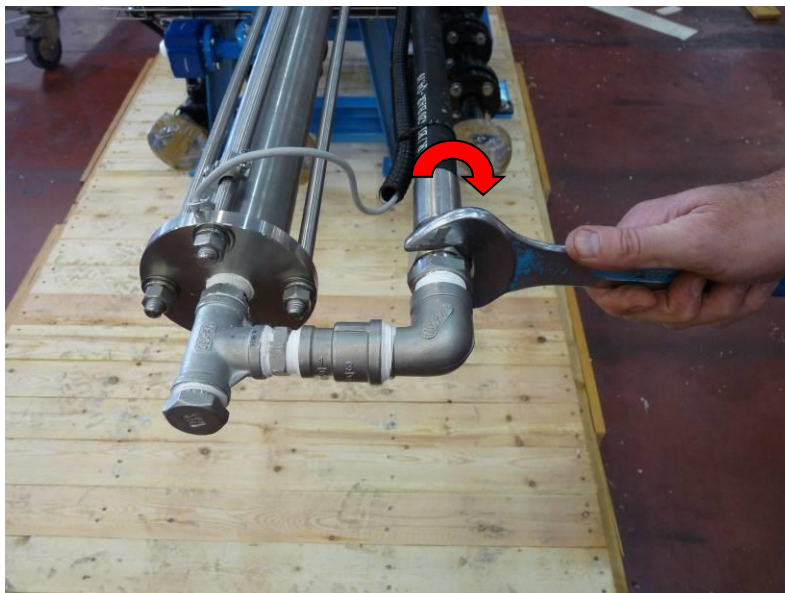

2. Disconnect the Proximity Switches SW1 and SW2 from the Piston House Assembly by unscrewing the sensors from their Mounting block.

**Important note: Make sure that the Mounting Blocks stay at their current position! Any movement of a block will affect the piston's calibration and will cause damage to the filter. Only the sensors should be removed!!!**

**SW1**

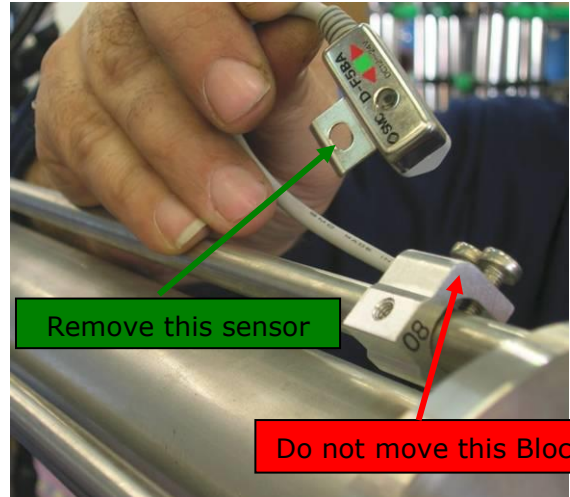
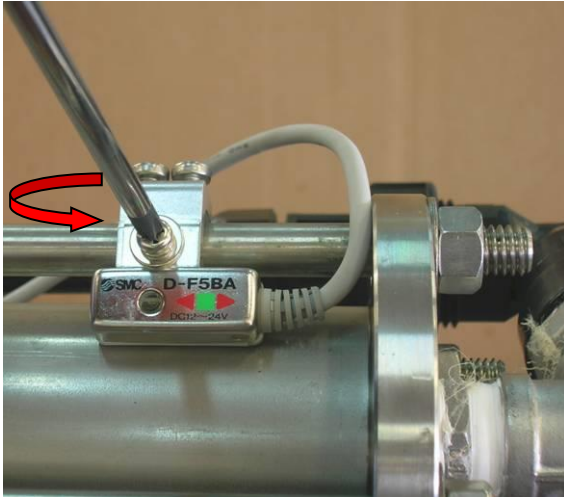

**SW2**

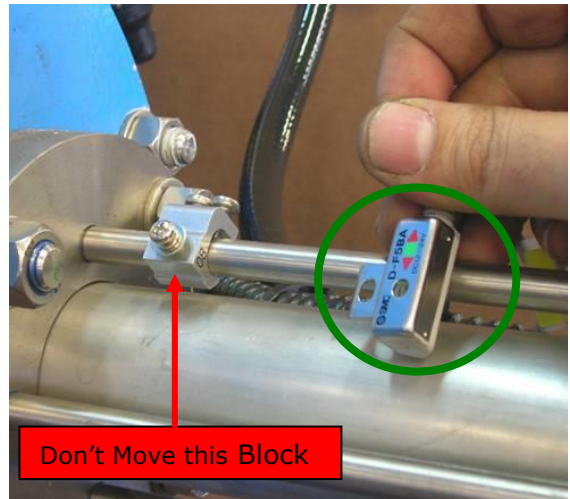
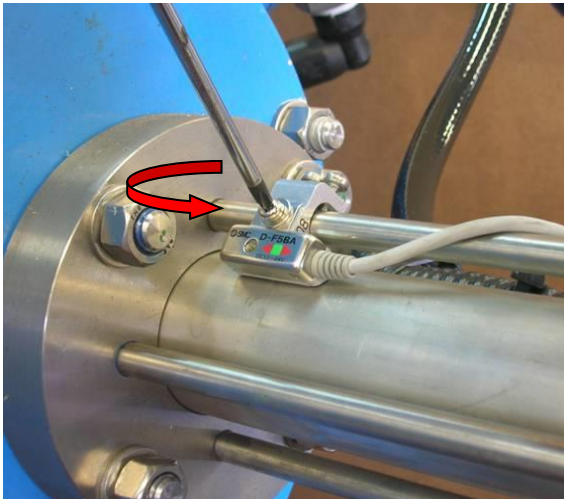

3. Unscrew the filter's Intermediate Cover bolts and open the Cover by gently pulling it out together with the Piston Hosing.

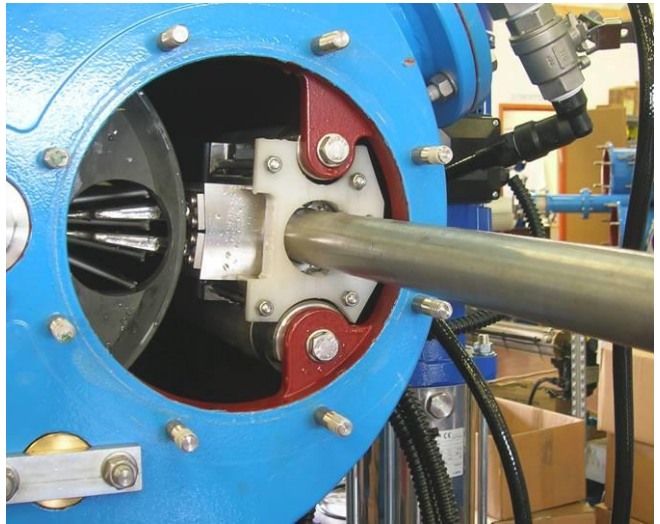
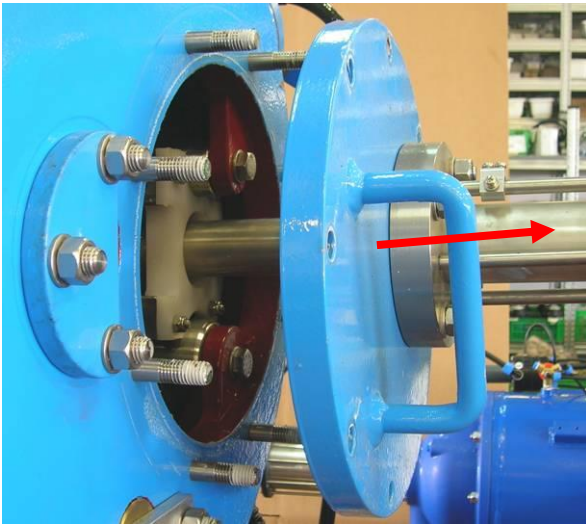
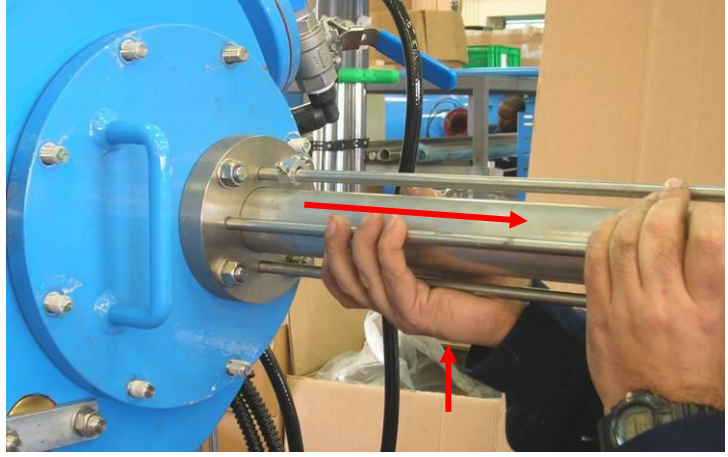
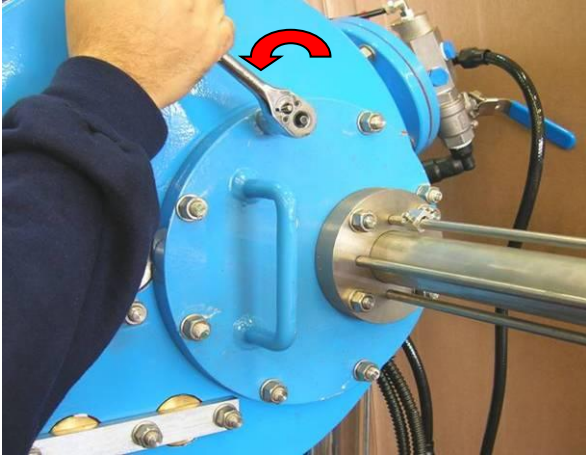

4. Make sure that the V-Shape Plate of the cartridge points to the central line of the filter, if necessary turn it by hand accordingly (1). Remove Piston#40 by pulling it straightly but gently out of the filter. Make sure not to damage the cassettes by letting the spray nozzles to hit the cartridge (2) while pulling the piston (you may need assistants to keep the piston balanced while pulling it out of the filter).

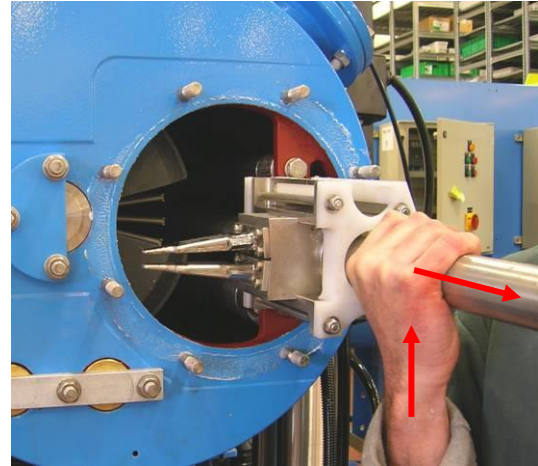
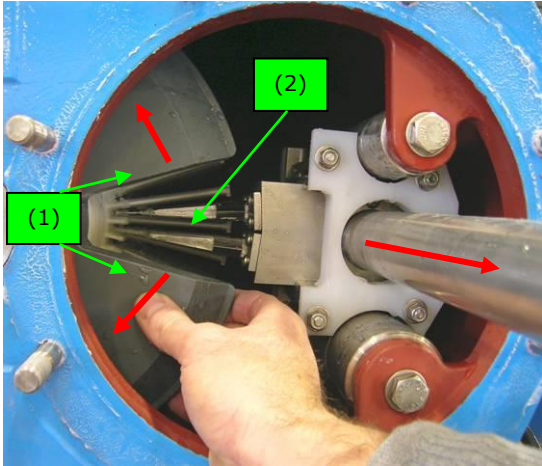

5. Using a flashlight inspect the interior of the filter and remove any foreign objects that may entered the filter housing during shipment. **Inspect the cartridge and in case that loosen or fallen cassettes are found do not proceed with the installation and contact your supplier immediately.**

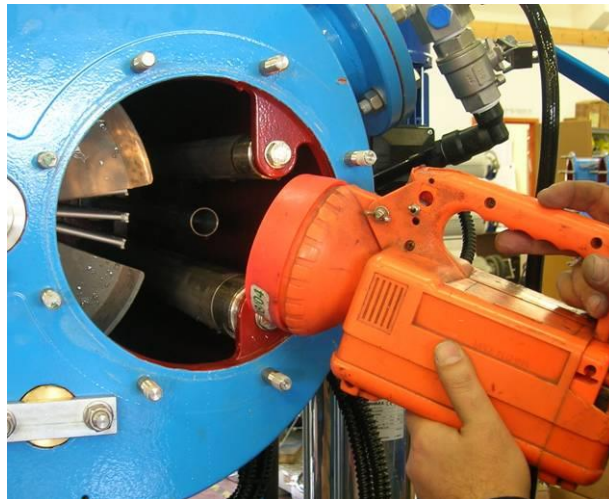

Inspect and re-tight all bolts:

Visually inspect the filter for loosen bolts, especially verify and re-tight the bolts of the entire filter covers.

Make sure that the filter is disconnected from any electrical power source; carefully open the control panel cabinet and re-tight the bolts of the terminal strips.

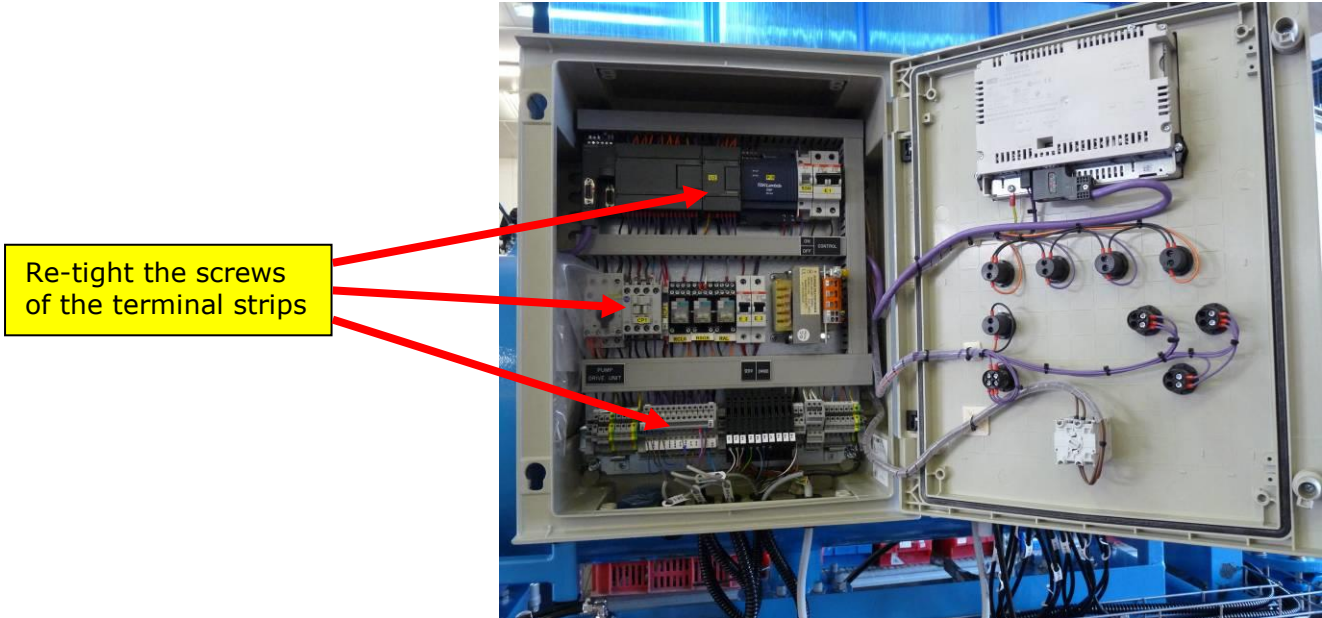

Piston and Piston Housing re-assembly:

1. Check that the V-Shape Plate of the cartridge points to the central line of the filter, if necessary turns it by hand accordingly. Insert Piston#40 into the filter body and make sure that the following three points are met:
  - i. The piston is inserted over the Tail Pipe Assembly located in the center line of the filter (1).
  - ii. The piston is inserted in the right direction (2).
  - iii. The spray nozzles are gently inserted in the gaps between the cassette rows (3) and are not hitting the cartridge while the piston is pushed in (you may need assistants to keep the piston balanced while pushing it into the filter).

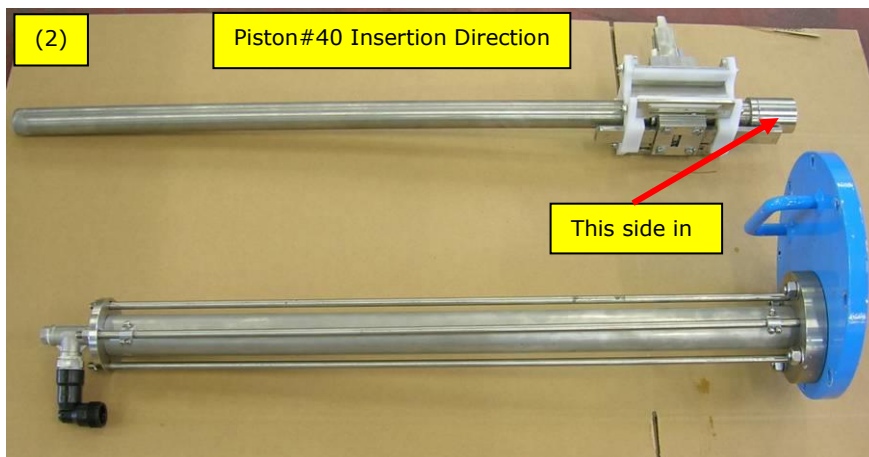

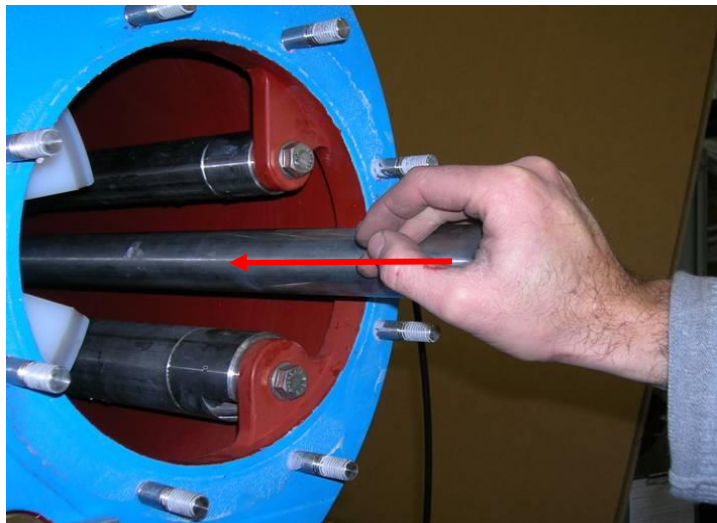
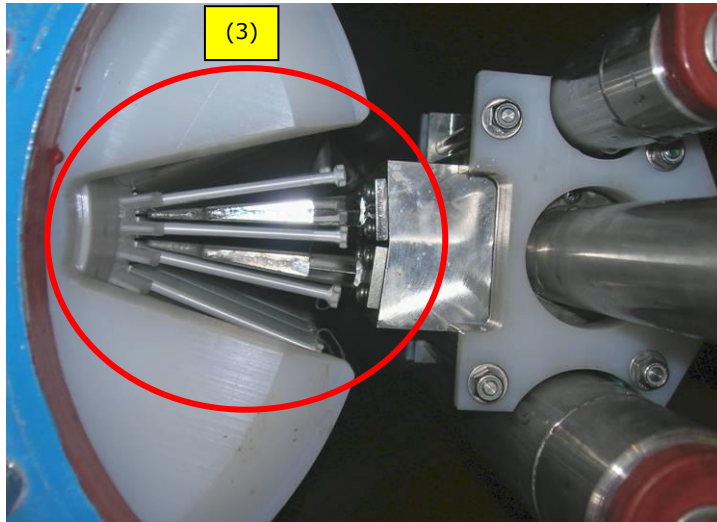
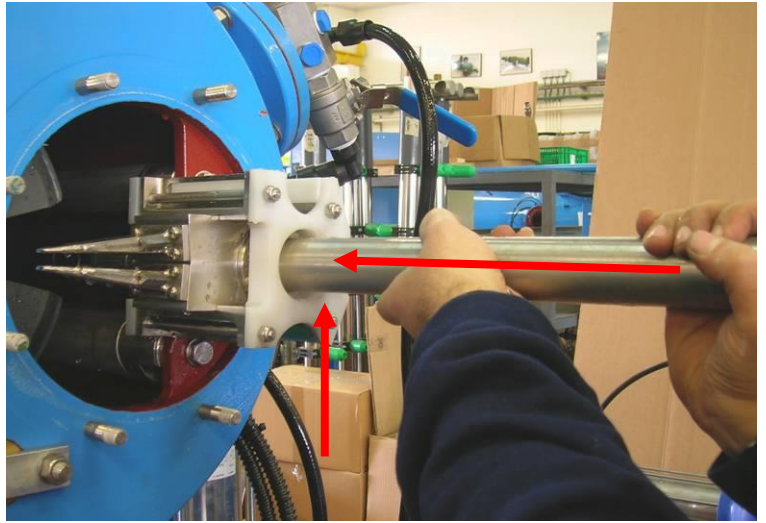
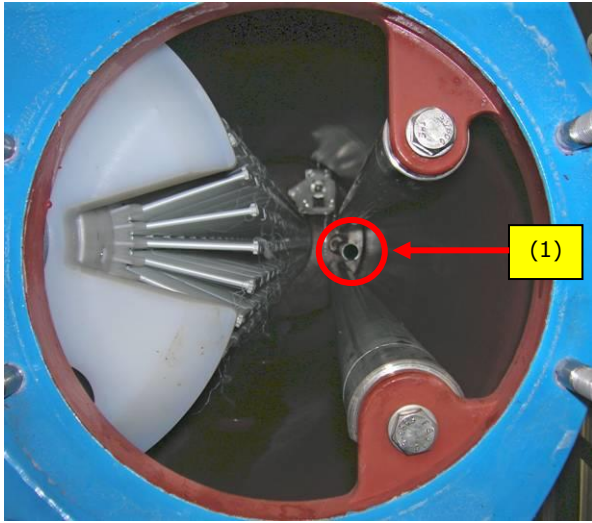

2. Gently Push Piston#40 into the filter till it slightly sticks out of the filter housing.

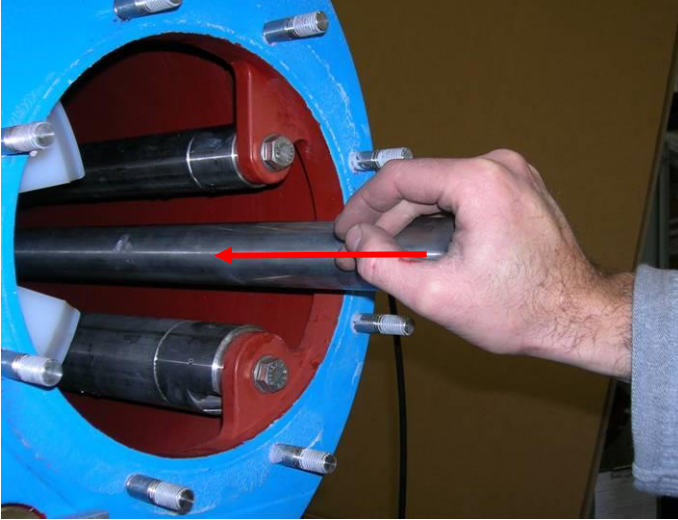

3. Insert the Piston Housing and the filter's Intermediate Cover over Piston#40. Then re-screw the Cover bolts. Make sure that these three components are aligned verify that the Cover's O-ring is in place.

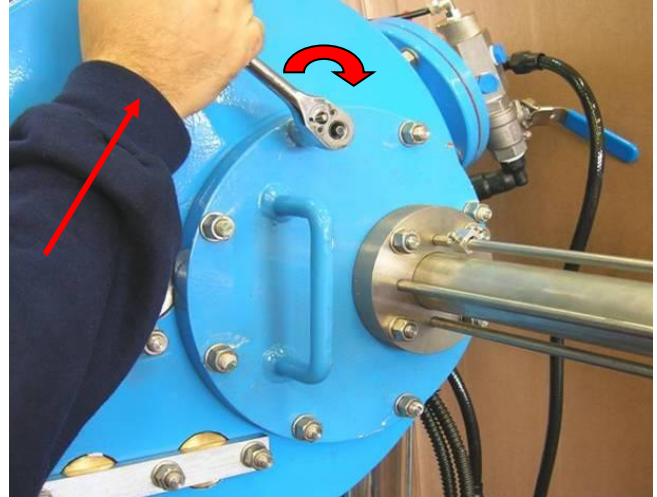
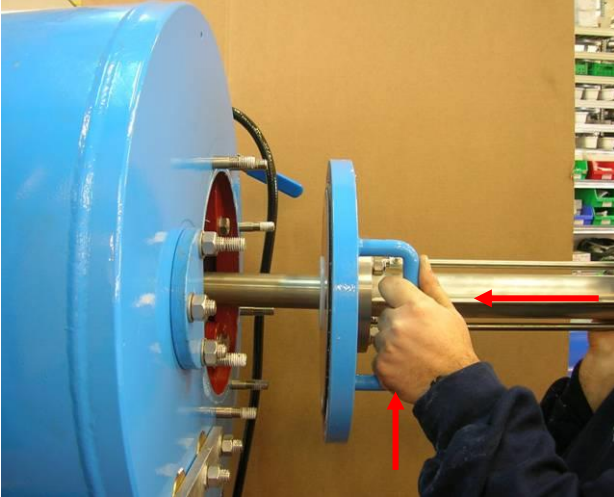



4. Re-connect the Proximity Switches SW1 and SW2 to the Piston House Assembly by screwing the sensors to their Mounting blocks.

**SW1**

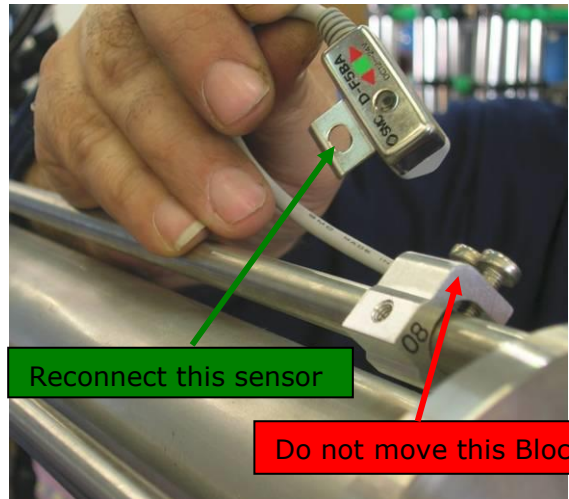
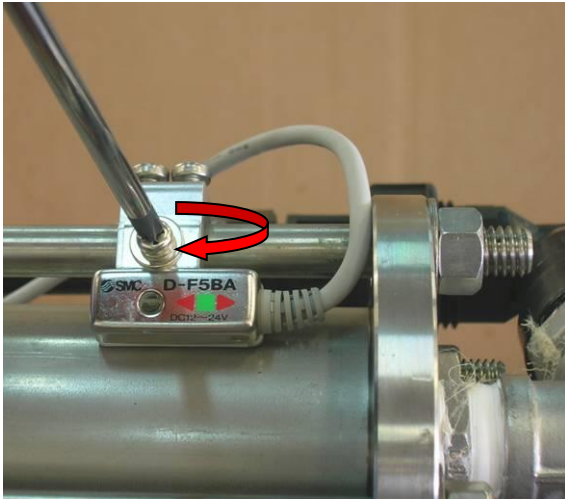

**SW2**

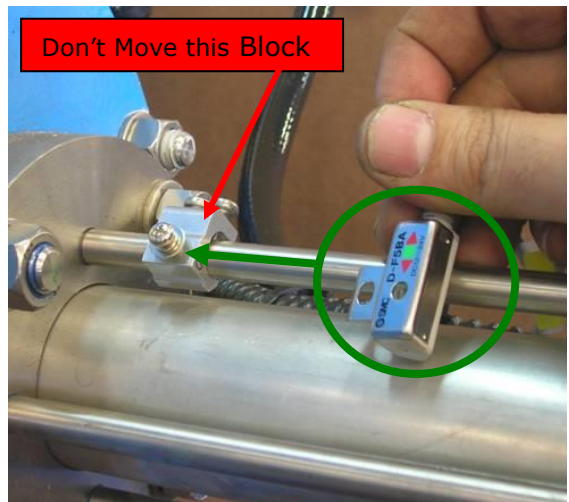
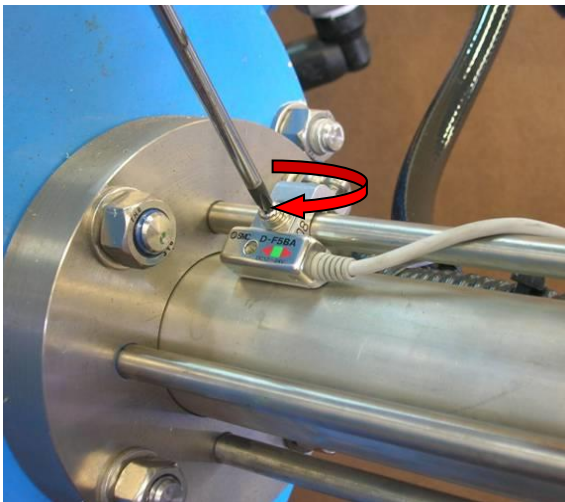

**Note:** Do not change the position of the mounting blocks! It was calibrated in the factory.

5. Re-connect the High Pressure pipe to the far end of the Piston House Assembly.



6. Make sure that Piston #40 is pushed out of the cartridge to ensure that the spray nozzles are not within the cassette package limits:
- i. Remove the plug from the piston inlet located at the left side of the cartridge cover.
  - ii. Insert a clean and straight 4.5 meter 0.5" pipe or rod (the Tune-up rod) through the opened connection.
  - iii. Using the rod push the piston all the way in.
  - iv. Remove the rod out of the filter and reassemble the plug.

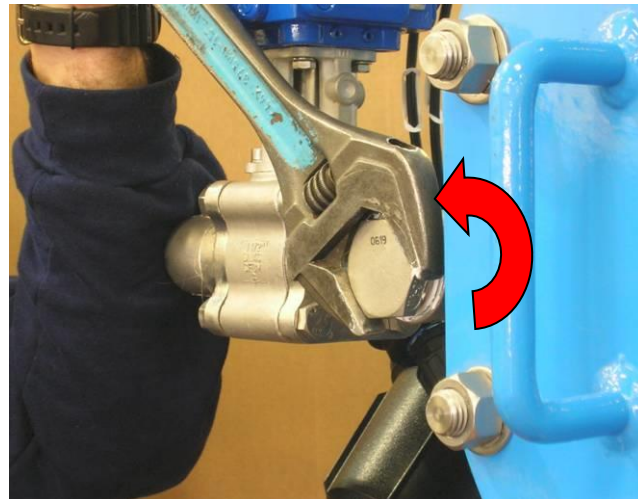

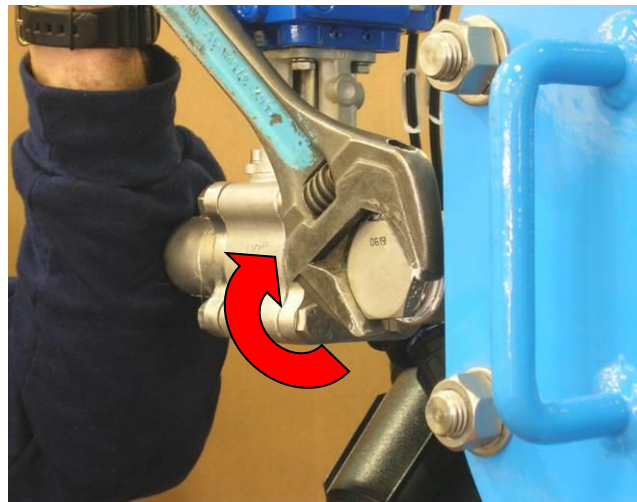
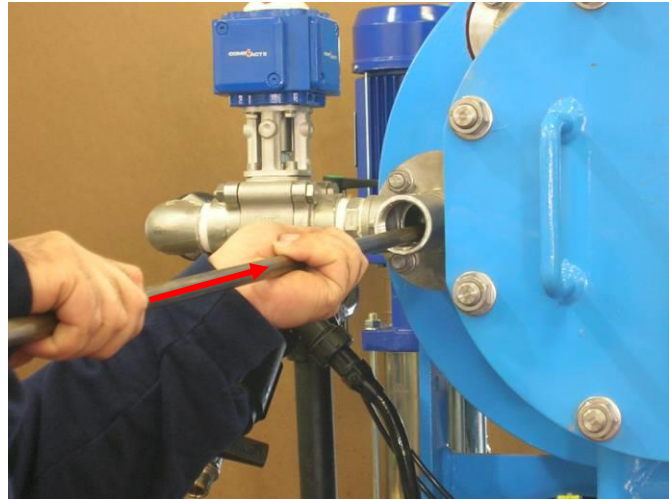
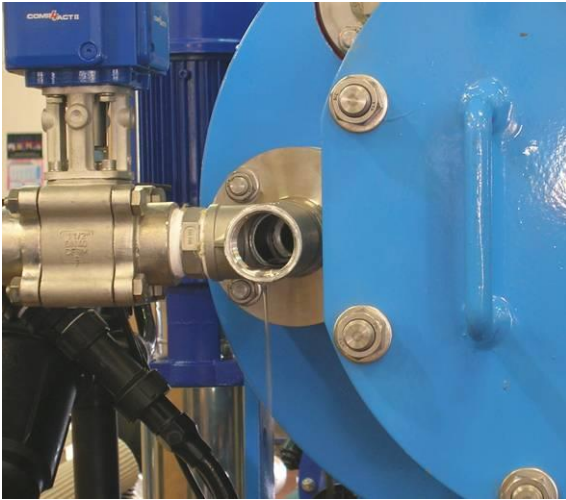

#### 2.2.4 Power Supply– Electricity and Pneumatics

The filter's Power and Compress Air connections are described in a set of certified drawings prepared for your filtration site requirements according to Amiad's Application Engineering Department specifications. Please ask your qualified electrician to connect the appropriate protection devices and the electrical cables to the control unit of the filter. Connect the compressed air supply to the appropriate terminals in the filter solenoids' cabinet.

#### Important notes:

- **Do not switch on the power and the compressed air supply at this stage!**
- **Switching on these systems prior to the commissioning procedure of the filter may cause damage!**
- Please take extra care when connecting the power and the compressed air to the filter, always exercise the relevant safety instructions

The following pictures show a typical Electrical Wiring and Compress Air Connections. They **do not replace your certified drawings** and are given here for broadening the end-use knowledge only.

The Control Panel

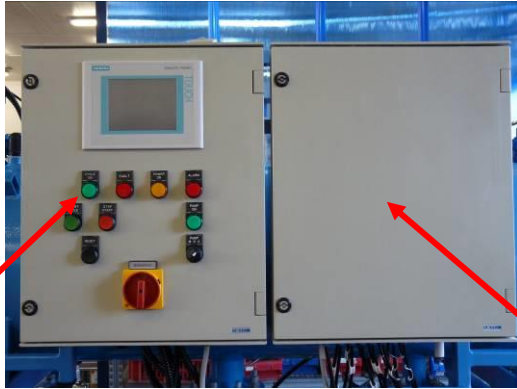

The PLC Cabinet

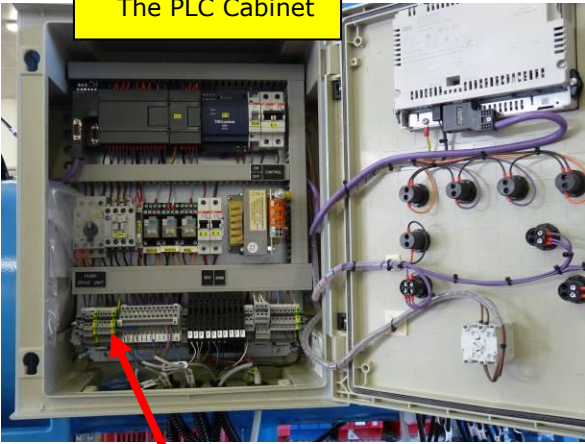

The Solenoids Cabinet

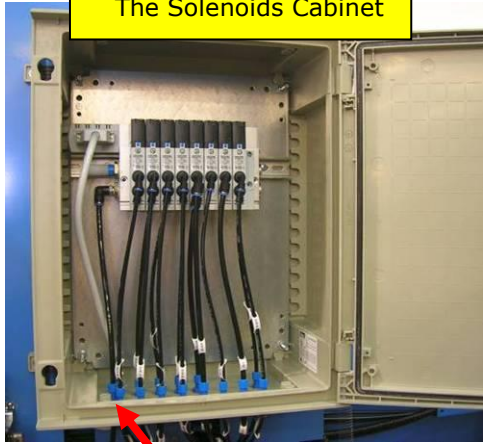

Main Power Supply  
Connection terminal

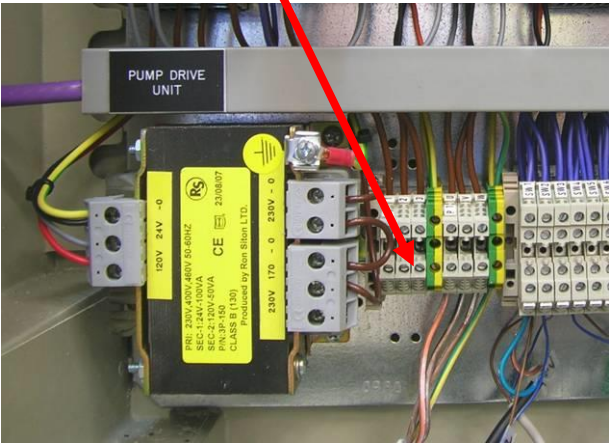

Compressed air  
Connection terminal

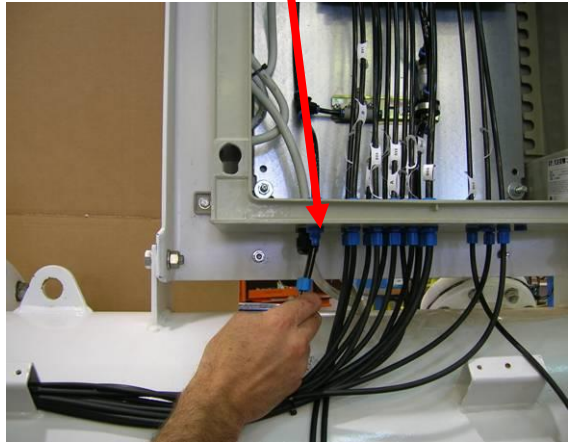

### **3. Description of the control panel**

#### **3.1 Introduction**

Amiad's AMF 36K filter automatic operation is carried out and controlled by a control panel. The control panel consists of electrical, electronic and pneumatic components integrated and installed in the control-panel's enclosure that is mounted to the filter housing at an easy to access point. The control panel includes two Cabinets: the PLC cabinet and the Solenoids Cabinet and it serves also as the filter's user interface allowing the user to monitor the filter operation and to adjust certified operation parameters and set-points.

#### **3.2 Components mounted on the control panel door**

In order to provide the end-user with an easy to master user interface several control elements are mounted on the outside of the control panel enclosure:

##### Switches:

- MAIN SWITCH – used to switch On/OFF the main power supply
- MANUAL/OFF/AUTO selector switch – used to set the flushing pump operation mode

##### Lamps:

- POWER ON lamp – indicates the status of the filter's Power Supply
- FAULT red signal lamp - lights on when the system is in Fault Mode
- ALARM red signal lamp - lights on to indicate system's Alarm or Attention Signal
- CYCLE ON green lamp – lights on when the filter is in Flush Mode
- PUMP ON green lamp – lights on when the flushing pump is running

##### Push buttons:

- START CYCLE push button – used to start a manual flushing cycle of the filter
- Emergency STOP CYCLE push button – used to stop the flushing cycle in emergency situations
- RESET push button – used to clear fault conditions

##### Display panels:

- PLC DISPLAY PANEL – used to read various status data and enter set points

The following picture shows the layout of the control elements mounted on the external side of the control panel PLC cabinet door:

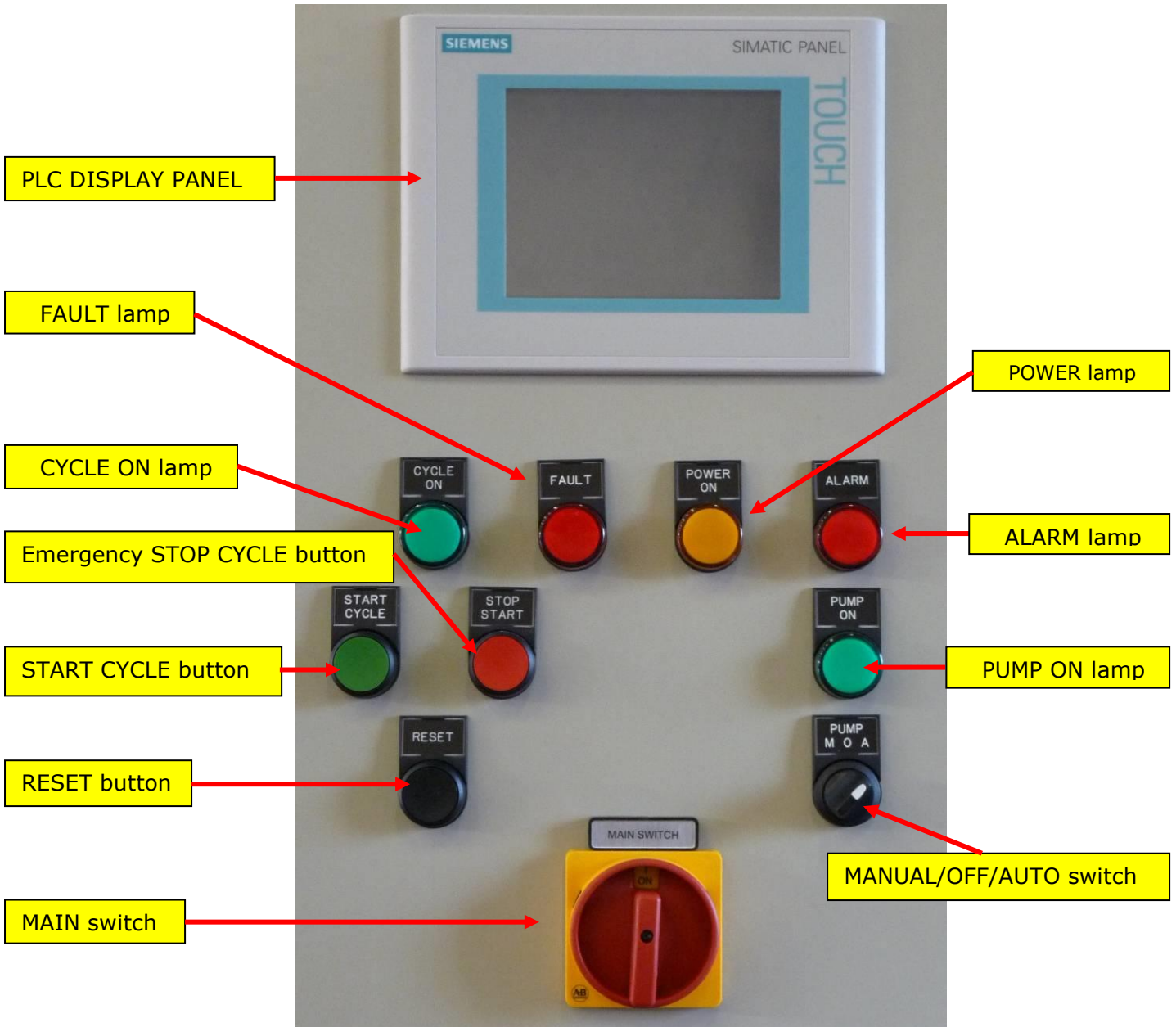

### 3.3 Internal components of the control panel

The rest of the control panel components that are not related to the user interface are mounted inside the control-panel's enclosure according to the IP65 standard. Accesses to these components is allowed only to qualified by Amiad technicians who are familiar with Amiad's "AMF-control panel description.DOC" and other Amiad technicians' text books.

In general the internal components of the control panel include elements such as: Power supply elements, PLC unit and extension components, Fuses, Circuit breakers, Over loads, Relays and Solenoids and other similar control elements. The following drawing (Fig26) is a general purpose demonstration drawing of the control components. This drawing does not replace your certified drawings and it is given here only for broadening the end-user's knowledge.

### 3.4 Basic operation of the PLC

In order to operate the filter it is absolutely important for the user to be familiar with the operation method of the PLC through its HMI display as described briefly in this chapter and in details in Amiad's "HMI\_AMF93\_092010.doc" text book. It is also very important for the user to understand the system status terminology, especially it is important to distinguish between the following 3 terms:

- **System Fault** – a major malfunction of one (or more) of the system components that caused the whole system to halt.
- **System Alarm** – a second level notification indicating a malfunction of one (or more) of the system components. In multiple filters installation this may indicate a malfunction that stopped one of the filters while the rest of the system filters continue to work. In a single filter installation such malfunction leads immediately to System Fault.
- **System Attention** – a malfunction of one (or more) of the system components that was overcome automatically by the control system of the filter. For the user knowledge only.

The electronic control system of the AMF<sup>2</sup> filter consists of two major components:

1. The PLC – Siemens S7-200 PLC; this component contains the operational algorithm of the filter and is responsible for its actual operation. It is important for the user to understand that once running the PLC software operates the filter independently; even without being connected to any user interface device. The PLC software contains internal default values for all the required operation parameters and once it is connected to power supply it operates the filter.
2. The HMI panel – This component serves as a user interface device connecting between the internal PLC software and the user and allowing data exchange between the PLC and the user. Amiad provides several HMI panels to be connected to the Siemens PLC; the selection of the appropriate panel depends on the specific filter, project or site requirements. This document describes the Amiad HMI software based on Siemens TP-177-B 6" panel.

#### 3.4.1. Basic operation of the panel

The TP-177-B panel is a touch screen panel; it contains no keyboard and its operation is done by touching graphical elements appearing on its screen.

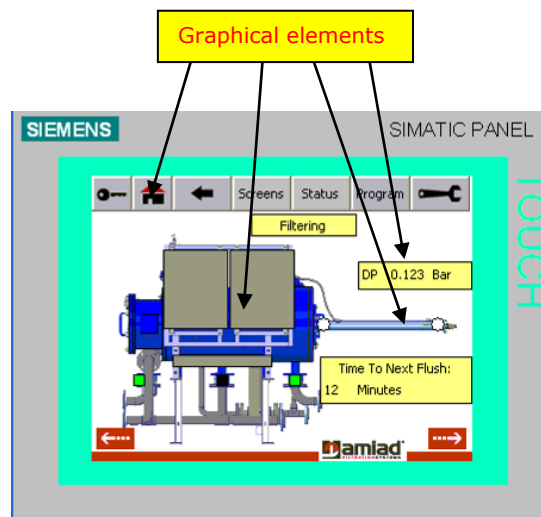

While operating the unit it is important to be aware of the following general issues:

- Unintentional actions - Unwanted actions may be triggered if the operator unintentionally touches several graphic elements (keys) at once. Never press more than one element at a time.
- Screen damage - Operation of the screen with hard, pointed or sharp objects or hard impact may lead to a considerable reduction of the service life and even to complete failure. Always use your fingers to operate your HMI device.
- Help Screen – Whenever a question mark key [?] is shown on the screen a help screen is available. Press and **hold** the [?] key in order to read the help screen.

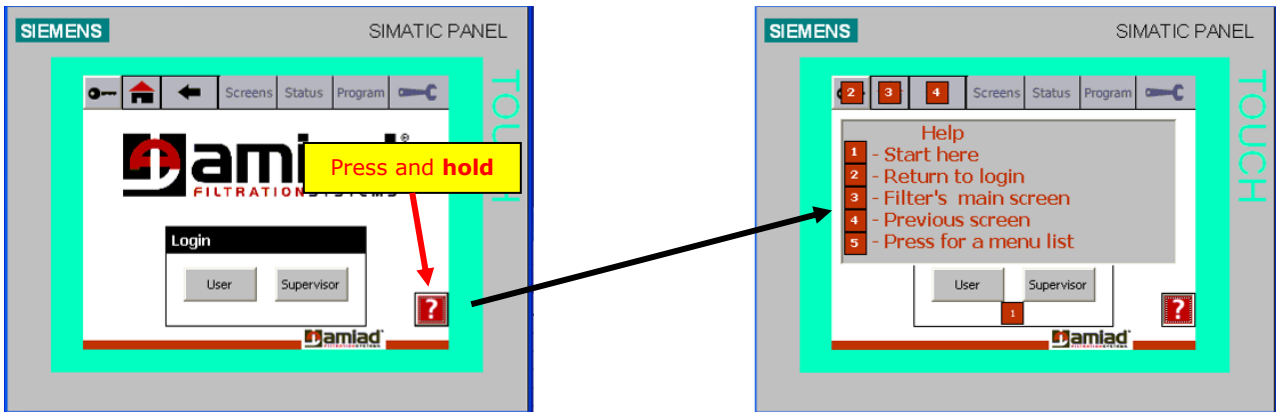

- Data entry – since the HMI panel doesn't have a physical keyboard, a virtual keyboard is displayed automatically whenever the user presses a graphical element which requires data entry. The following picture shows the virtual keyboard:

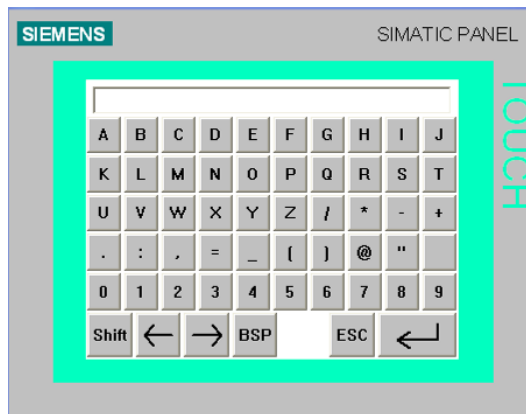

The Virtual keyboard contains the following keys:

- Entry line – across the upper border of the screen
- Alphanumeric keys – in the middle section of the screen
- Navigation keys – across the lower border of the screen
  - Shift key (for uppercase characters)
  - Left and Right Arrow keys
  - Backspace key (BSP)
  - Escape key (ESC) for returning without writing
  - Enter key



- Logging into the system - The HMI panel may be operated by three types of users:
  - Regular user – no password is required for logging in as a regular user; the regular user can see all the screens and the data elements of the system but he cannot change any parameters.
  - Supervisor – A supervisor password is required for logging in; the supervisor can see all the screens and the data elements of the system and he can change all the parameters of the regular day to day operation of the filter, i.e. flushing “Time – Interval”.
  - Administrator – The administrator can see and change all the data elements of the system including changing the very sensitive filter configuration parameters. An administrator password is required in order to login as an administrator.

The following pictures show the main login screen and its operation.

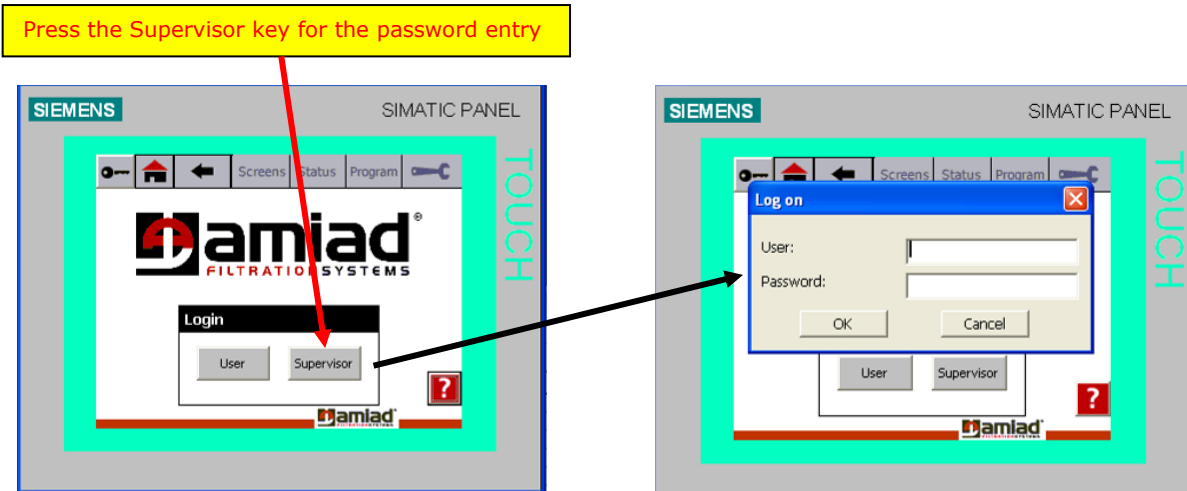
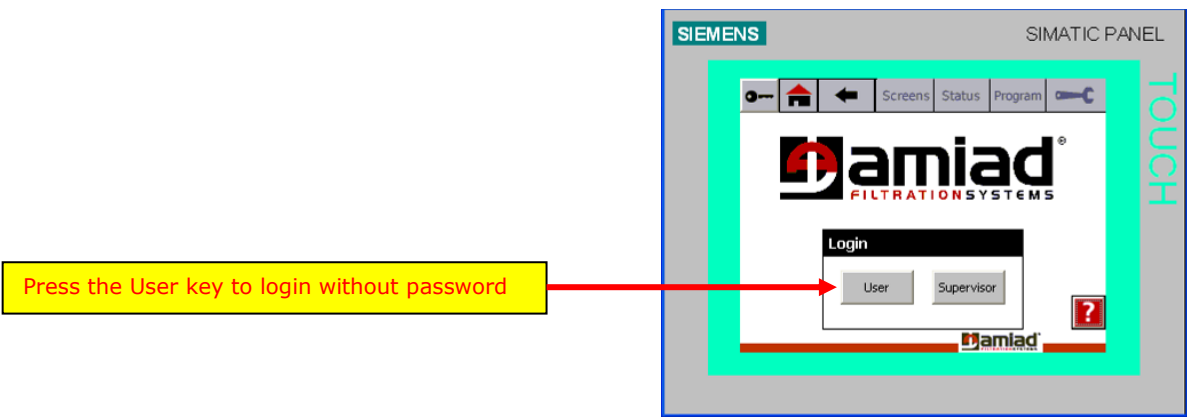

Your Supervisor user name is: super  
 Your Supervisor password is: 9876  
 Your Administrator user name is: \_\_\_\_\_  
 Your Administrator password is: \_\_\_\_\_

**Notes:**

1. Please contact your Amiad representative for Administrator login details
2. Attempt to change an unauthorized parameter within the system opens the login screen

### 3.5 HMI operation principles

The HMI operation is based on the following main components:

- Menu bar – The menu bar appears across the upper border of the screen and is consist of rectangular keys. Some of these keys can perform a single operation, while the other keys when pressed open a vertical menu-list that contains other single operation keys.

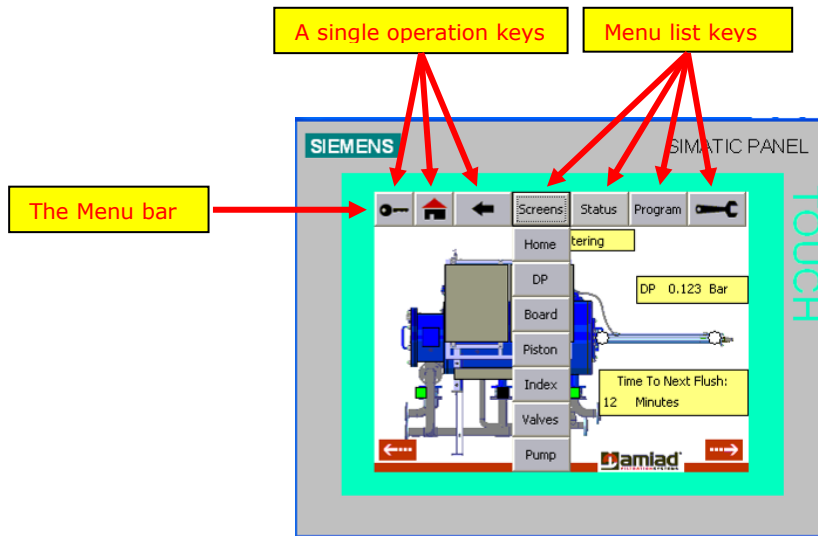

- Graphical Screens – Screens with pictures showing the filter or its parts. These screens show the various filter components in action. The color of the components and their motion across the screen is changing according to the operation of the filter in real time. Pressing on some graphical elements operate a zoom-in and the specific filter element is shown in details.

Graphical screens showing motion

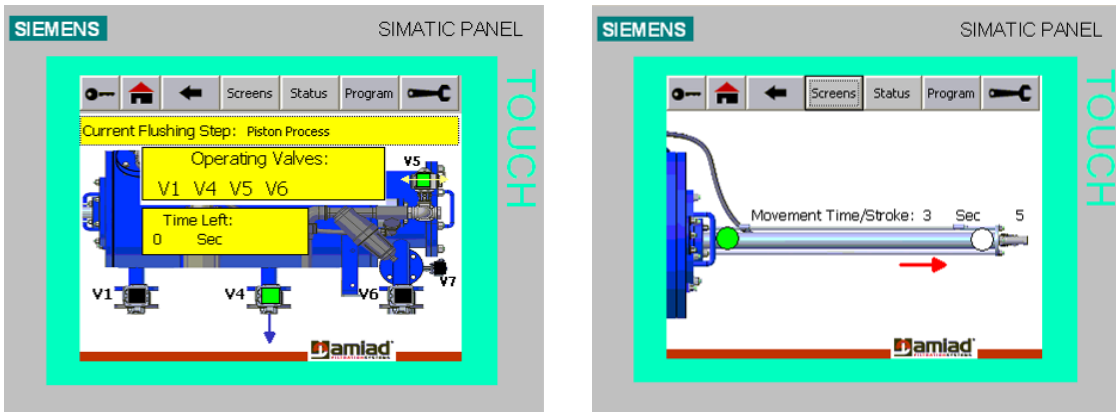

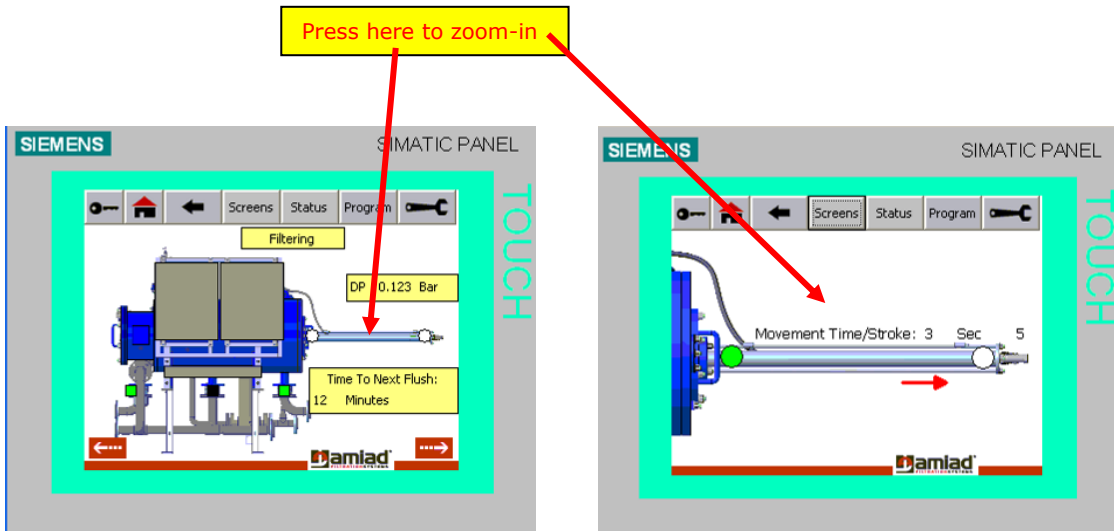

- Tables Screens – Screens containing a table showing alphanumeric data on various filter components, system messages or operation parameters. Some of these screens are for showing information only while other tables screens are for data entry (depends on a specific login authorization). **Please note:** Black color data items are for your information only while Blue color data items showing parameters to be adjusted by the system’s Supervisors and Administrators.

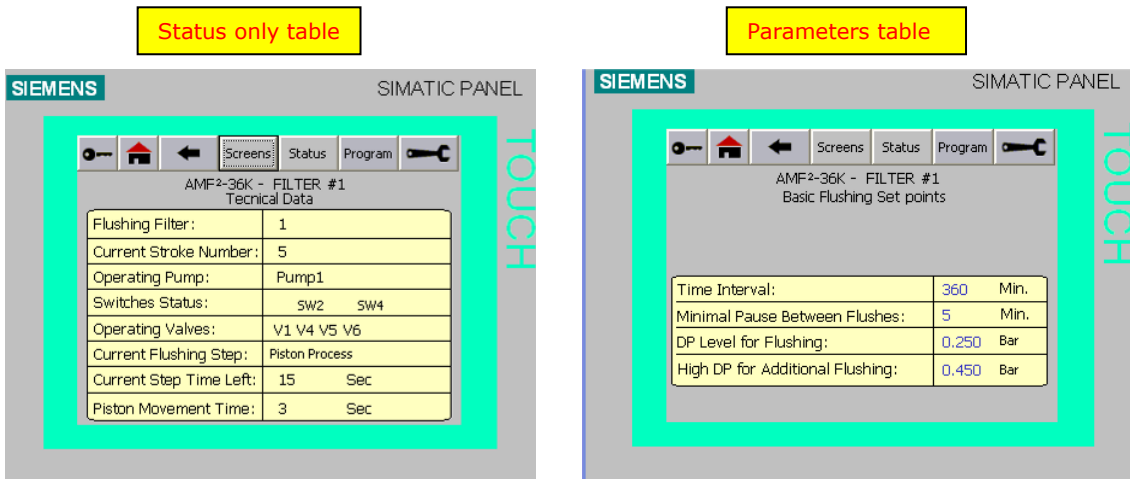

- On Screen Messages – These HMI components appear on the Graphical Screens near some filter components. The On Screen Messages show:
  - Status data regarding regular filter operation i.e. “Time to next flush” or current “DP reading”.
  - Error messages regarding faulty filter operation or components.
All the On Screen Messages appear in black on a Yellow background. When pressing on an On Screen Message the system moves to the applicable Table Screen showing detailed information regarding that message.

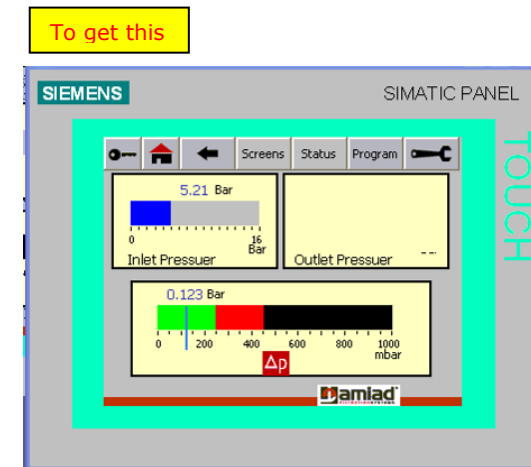
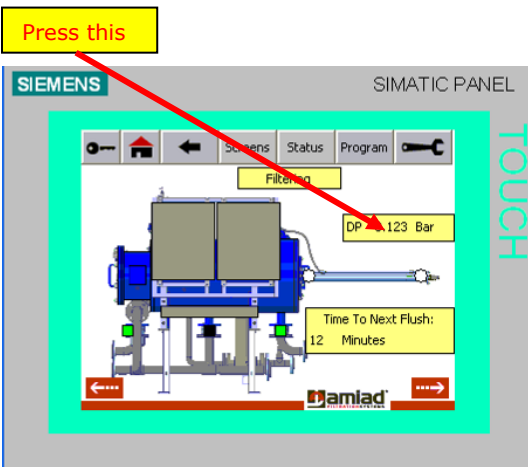
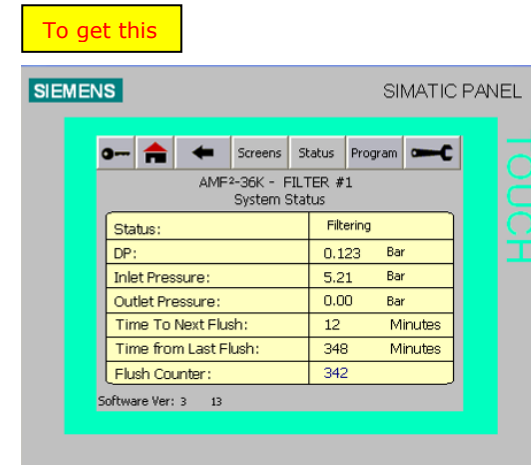
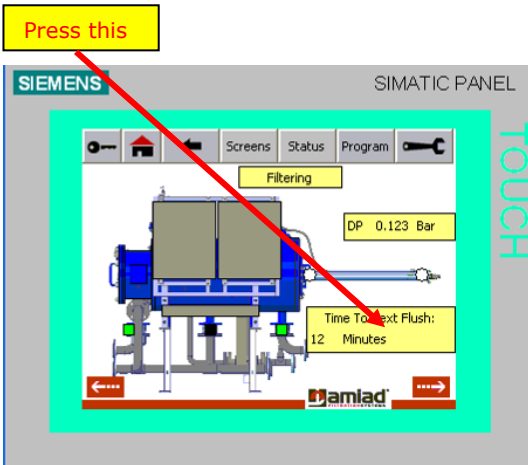
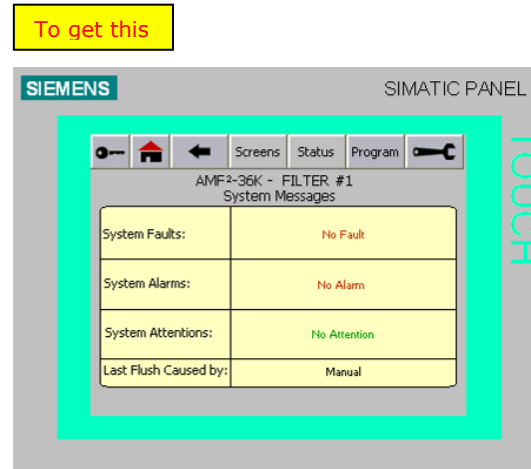
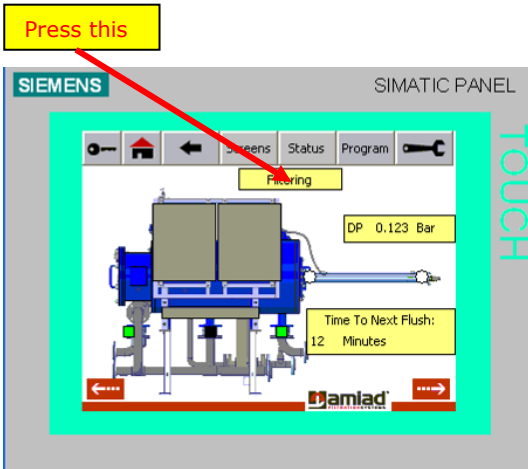

### 3.6 Finding your way within the system

There are several ways to move about the system and the user may even combine between them to his convenience:

#### Using the single operation keys:

There are three single operation keys:



The Login key – Pressing this key at any time or from any screen moves the system back to the login screen. The user may use this key in order to return to the entry point of the system or for switching between user types (User, Supervisor or Administrator).



The Home key – Pressing this key at any time or from any screen moves the system back to the main screen of the filter. The main screen (the Home screen) is the first graphical screen shown immediately upon completion of the login process. This is the entry point to the actual operation of the filter. The user may use this key whenever he likes to return to the beginning. **Please note** that the main screen gives the current general status of the filter.



The Back Key – Pressing this key at any time or from any screen moves the system to the previous screen, much like the “go back one page” of a regular Internet browser.

#### Using the Menu lists:

The menu lists are groups of single action screens that fall into the same category. There are four menu list groups:

- Screens – This group contains the entry points to all the graphical screens of the system. In order to jump to a specific graphical screen press the [Screens] key and choose your desired screen from the list, i.e. Piston, Index, etc.
- Status – This group contains the entry points to all the status table screens of the system. In order to jump to a specific status screen press the [Status] key and choose your desired screen from the list, i.e. System status, Messages, etc.
- Program – This group contains the entry points to all the program table screens of the system. In order to jump to a specific status screen press the [Program] key and choose your desired screen from the list, i.e. Set Points or Set Time.
- Tools – This group contains the entry points to all the tools and configuration table screens of the system. In order to jump to a specific configuration screen press the  key and choose your desired screen from the list, i.e. Config., Set up, Valves, etc.

#### Using the Graphical screens:

The graphical screens contain drawings of the filter; the user may press on any working element of the filter in order to zoom-in to that element specific screen. Please note that in the main screen (home screen) it is possible to rotate the filter clockwise and contra clockwise in order to reach the elements at the other side of the filter, i.e. rotate the filter out of the front view in order to reach the flush pump at the rear view of the filter.

#### Using the On Screen Messages:

Use the On Screen Messages to jump to their relevant table screen. This option is very useful when tracking the reason of a filter fault; the user may press the fault message in order to jump to the system messages screen for additional information regarding the fault.

### 3.7 Changing the HMI language

One of the HMI features is its multilingual ability; the user can change the interface language on-the-fly by selecting the required language at the Tools / Language Menu.

The language changing screen displays national flags of the countries whose languages are available at the HMI system, in order to change the language the user have to select the appropriate flag at this screen.

The following picture shows the language changing screen:

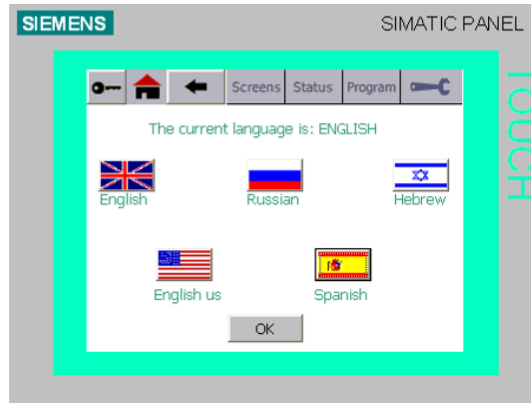

#### **Important Points:**

##### Finding the language changing screen:

It is possible that the user doesn't know the current HMI language and he would like to change it to a different language when not being able to read the current menu entries. This is why the label on the main menu's tools entry is the  icon, so it can easily be selected in any language. The language selecting screen is the first entry under the tools menu and in all the languages its label is "Lang."

##### The Hebrew language:

Since the Hebrew language is written from right to left, the regular left-to-right tables are not suitable for Hebrew. Therefore, when changing the language to Hebrew the system changes the tables' direction accordingly. Please note that after a power failure the system returns to the last used language. If the language was Hebrew and after a power failure you notice that the tables' direction is incorrect please select the Hebrew language again.

##### UK versus US English:

The language of the UK and the US English in the HMI system is actually the same. The only difference is with the Pressure Measurement Units.

The UK English uses BAR while the US English uses PSI for the DP and the In/Out pressure meters.

**Important Note:** When changing between these two options the HMI changes the pressure parameters across the system according to the BAR or the PSI factory default parameters. Therefore if you use other than the factory default parameters, please recheck your entries after changing the pressure units.

### 3.8 HMI screens description

This chapter describes in detail the HMI screens divided into their categories:

#### 3.8.1 Login screens

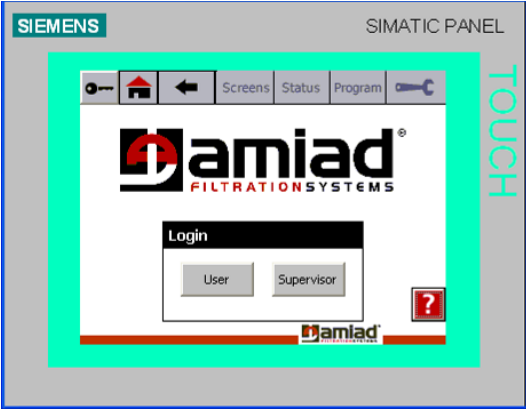
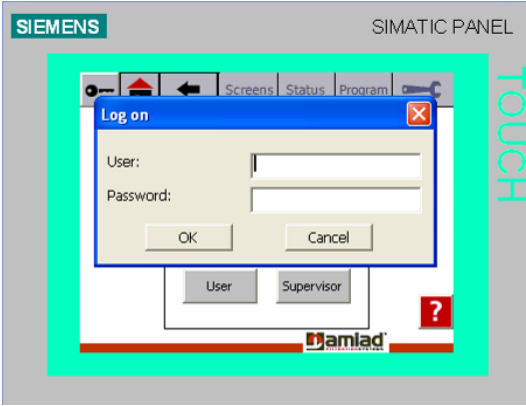
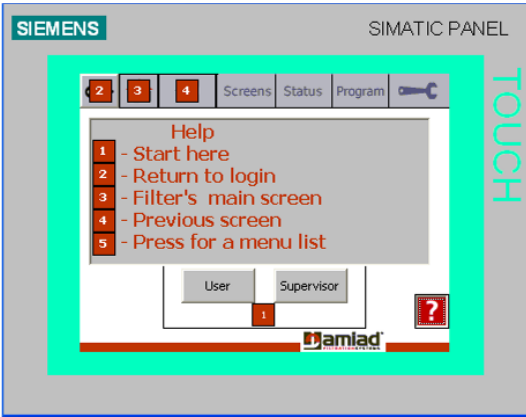
	<p><b>The Entry screen of the system</b> – appears when power is applied to the system.</p> <p><b>This screen allows the user to:</b></p> <p>Select the user type:</p> <p>Press [User] to login as a regular user</p> <p>Press [Supervisor] to display the supervisor and the administrator login screen.</p>
	<p><b>The Login Screen</b></p> <p><b>This screen presents:</b></p> <p>The Administrator and Supervisor login window.</p> <p>Enter your Administrator or Supervisor user name and password to login.</p>
	<p><b>The Help Screen</b></p> <p><b>This screen presents:</b></p> <p>The help screen.</p> <p><b>Press and hold</b> the question mark key in order to read the content of the help screen.</p>

### 3.8.2 Graphical screens

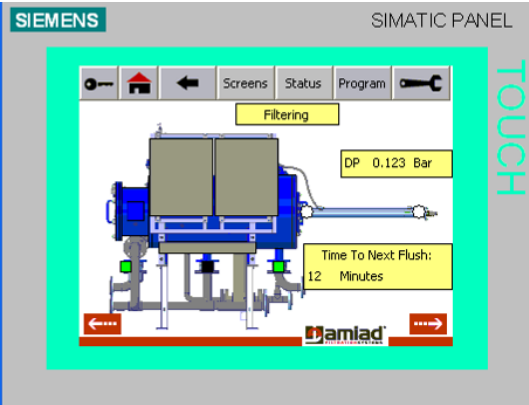
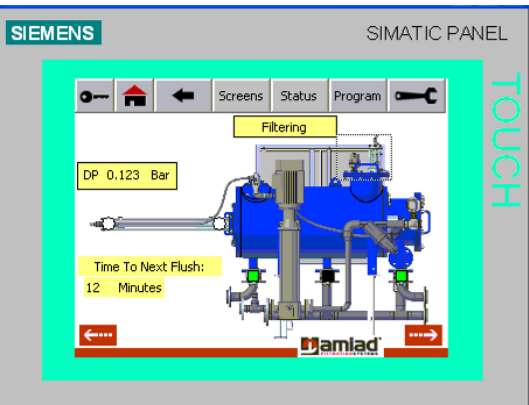
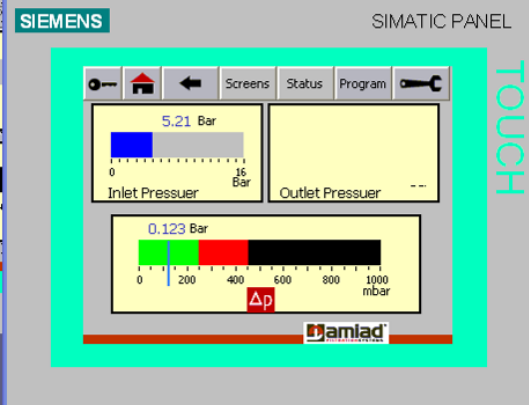
	<p><b>Main Screen - Front</b></p> <p><b>This screen presents:</b></p> <p>The status of the system – in the upper yellow box.</p> <p>The current DP reading – in the right yellow box</p> <p>The time to next flush - in the lower yellow box</p> <p>The filter drawing shows the status of the various elements of the filter such as valves, piston, etc.</p> <p>Press any filter element to zoom-in to the specific detailed screen.</p> <p>Press any yellow box to display the detailed relevant screen.</p> <p>Press the lower right and left red arrow keys to rotate the filter and to display the rear main screen</p>
	<p><b>Main Screen - Rear</b></p> <p><b>This screen presents:</b></p> <p>The status of the system – in the upper yellow box.</p> <p>The current DP reading – in the left yellow box</p> <p>The time to next flush - in the lower yellow box</p> <p>The filter drawing shows the status of the various elements of the filter such as valves, piston, etc.</p> <p>Press any filter element to zoom-in to the specific detailed screen.</p> <p>Press any yellow box to display the detailed relevant screen.</p> <p>Press the lower right and left red arrow keys to rotate the filter and to display the front main screen</p>
	<p><b>DP Screen</b></p> <p><b>This screen presents:</b></p> <p>The inlet pressure gauge at the upper right box</p> <p>The outlet pressure gauge at the upper left box (if exists)</p> <p>The DP gauge at the lower central box.</p> <p>The border line between the green and red areas represents the DP set point for regular flushing.</p> <p>The border line between the red and black areas represents the DP set point for High DP flushing.</p>

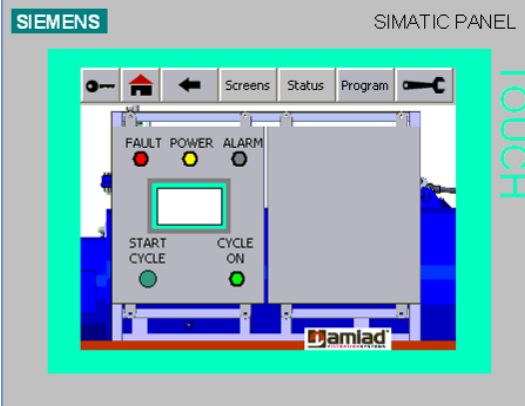
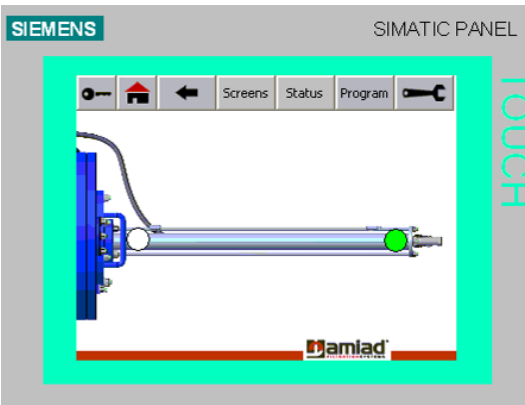
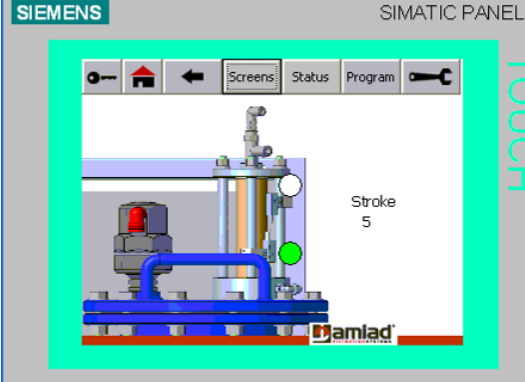

	<p><b>Board Screen</b></p> <p><b>This screen presents:</b></p> <p>The electrical board of the system.</p> <p>The lamps on this screen change color according to the actual status of the filter.</p> <p>Please note that in some HMI versions the Start Cycle button is not active. In such case use the physical Start Cycle button on the actual electrical board of the system.</p>
	<p><b>Piston Screen</b></p> <p><b>This screen presents:</b></p> <p>A detailed piston drawing that shows the following:</p> <ul style="list-style-type: none"> <li>SW1 &amp; WS2 status (green or white according to the actual position of the piston)</li> <li>The movement of the piston during flushing together with the stroke number and time.</li> <li>Attention messages (when applicable) at the area under the piston drawing.</li> <li>Alarm and Fault messages (when applicable) at the area above the piston drawing.</li> <li>Alarm and Fault status (appear on the piston in red)</li> </ul>
	<p><b>Index Screen</b></p> <p><b>This screen presents:</b></p> <p>A detailed index drawing that shows the following:</p> <ul style="list-style-type: none"> <li>SW3 &amp; WS4 status (green or white according to the actual position of the index)</li> <li>The movement of the index during flushing together with the stroke number.</li> <li>Attention, Alarm and Fault messages (when applicable)</li> </ul>

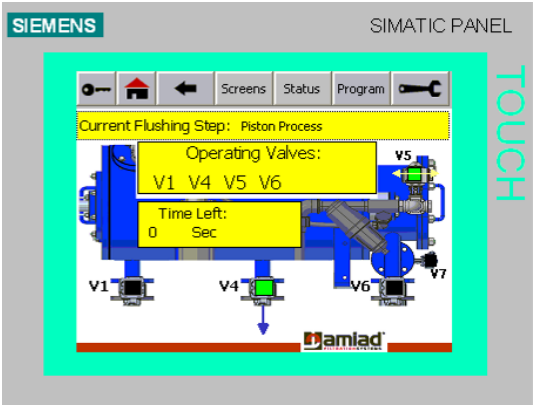
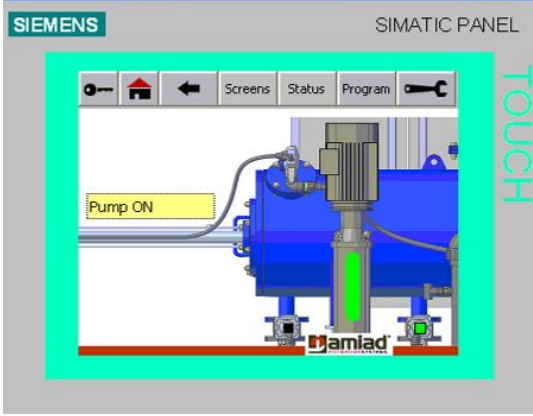
	<p><b>Valves Screen</b></p> <p><b>This screen presents:</b></p> <p>A detailed valves drawing that shows the following:</p> <p><b>Text boxes:</b></p> <p>The current flushing step (during flushing).</p> <p>The labels of the operating valves.</p> <p>The time left till the end of the current flushing step.</p> <p><b>Graphical elements:</b></p> <p>The status of the valves together with a direction arrow (green = operated black= not operated)</p>
	<p><b>Pump Screen</b></p> <p><b>This screen presents:</b></p> <p>A detailed pump drawing that shows the following:</p> <p><b>Text box:</b></p> <p>The current pump status.</p> <p><b>Graphical elements:</b></p> <p>The status of the valves</p> <p>The status of the pump</p> <p>green = operated</p> <p>black= not operated</p> <p>red = fault</p>

### 3.8.3 Status screens

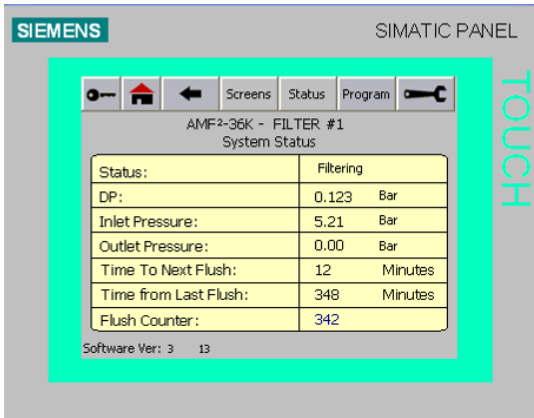
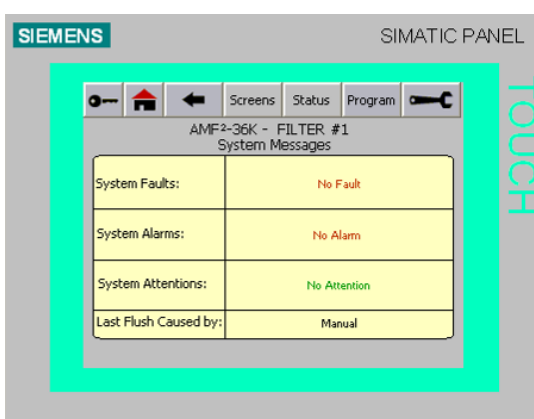
	<p><b>System Status Screen</b></p> <p><b>This screen presents the System Status Table:</b></p> <p><b>Status</b> – The general status of the system: Idle, Pause, Filtering, Back-flushing, Fault, Attention, Alarm, Delay, etc.</p> <p><b>DP</b> - The current Differential Pressure reading</p> <p><b>Inlet Pressure</b> - The current Inlet Pressure reading</p> <p><b>Outlet Pressure</b> - The current Outlet Pressure reading</p> <p><b>Time to next Flush</b> - Time to the next timed flush cycle. It reset back to the initial value with every flush cycle.</p> <p><b>Time from last flush</b> - The time passed from the previous flush.</p> <p><b>Flush Counter</b> - The total count of flush cycles.</p>
	<p><b>System Messages Screen</b></p> <p><b>This screen presents:</b></p> <p><b>System Faults</b> – When the system has no faults "No Fault" is displayed. In case of more than one fault message, the display alternates the existing fault messages once at every 3 seconds.</p> <p><b>System Alarms</b> – When the system has no alarms "No Alarm" is displayed. In case of more than one alarm message the display alternates the existing alarm messages once at every 3 seconds.</p> <p><b>System Attentions</b> – When the system has no Attentions "No Attention" is displayed. In case of more than one message the display alternates the existing Attention messages once at every 3 seconds.</p> <p>A list of possible system messages appears in chapter 3.9 of this manual.</p> <p><b>Last flush Caused by</b> - The cause of the previous flush: DP, High DP, Time, Remote or Manual</p>

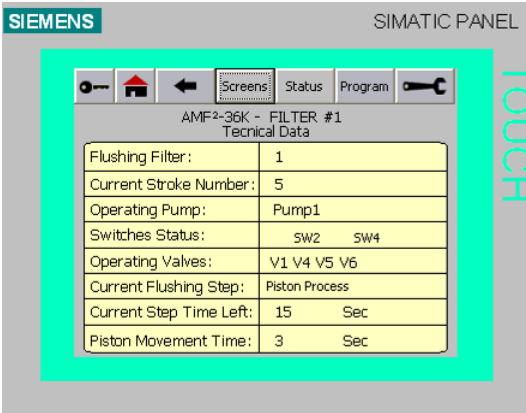

### Technical Data Screen

This screen presents:

**Flushing Filter** – The number of the flushing filter (1 in a single filter installation)

**Current stroke Number** - The current flushing stroke number (1-36)

**Operating Pump** – The number of the operating pump (Pump1 in a single filter installation)

**Switches Status** – The current status of the piston and index limit switches:

The Main Piston can be at limit switch SW1, at limit switch SW2 or in movement between them.

The Index Piston can be at limit switch SW3, at limit switch SW4 or in movement between them.

**Operating Valves** – The numbers of the currently operating valves:

V1=Inlet valve is closed.

V4= Drain valve is open.

V5= Flush valve is open.

V6=Outlet valve is closed.

V7= Filtering to waste valve is open.

V9= Filling valve is open.

**Current flushing step** - one of the following options:

- Close Inlet & Outlet Valve
- Open Drain Valve
- Open Flush Valve
- Piston Process
- End Piston Process
- Close Flush Valve
- Close Drain Valve
- Open Filling Valve
- Open Inlet Valve
- Open Filter to Waste
- Close Filter to Waste
- Open Outlet Valve
- End Flushing

**Current step time left** – The time left till the end of the current flushing step.

**Piston Movement time** – The time accumulation of the current piston stroke

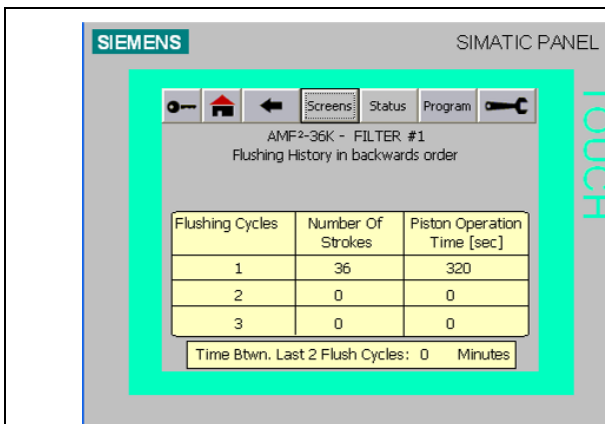

### Flushing History Screen

#### This screen presents:

A report of the last 3 flush cycles.

**The Stroke column** displays the number of strokes performed at each one of the last 3 flush cycles.

**The Time column** displays the total flush time of each one of the last 3 flush cycles.

**Time Btwn. Last 2 Flush Cycles** - The time passed from the previous flush cycle and the flush cycle before it.

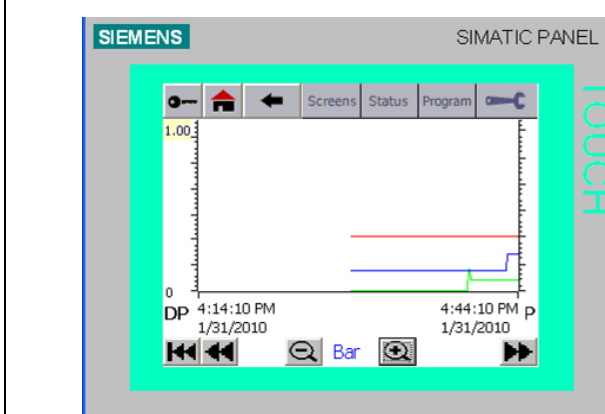

### Trends Screen

#### This screen presents 3 optional trends:

**The DP trend** (The blue line and the left Y axis)

**The Inlet pressure** (The red line and right Y axis)

**The Outlet pressure** (The green line and the right Y axis)

**The Zoom Keys** allow the user to set the span of the trends window.

Upon entering to this screen the trends span is 4 hours. Use the zoom keys to select between 0.5, 1, 2, 4, 8, 16 and 32 hours.

**The right and left arrows** move the trends window one screen to the left or to the right.

**The left most arrow** icon key returns the trends to the beginning point.

Since the left Y axis serves the Inlet and the Outlet Pressure Meters, the type of these two meters should be exactly the same.

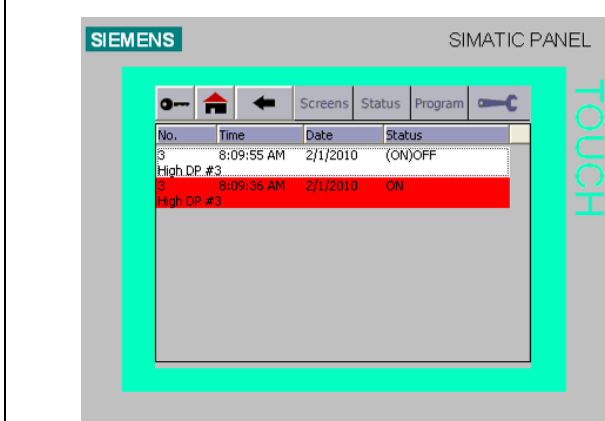

### Alarms Log Screen

#### This screen presents the Alarms and Faults log:

Each line contains the number, the time, the date and the status of the message.

The messages are color coded according to their type.

The messages are stored in a cyclic buffer and it is not possible to delete the messages.

The buffer size depends on the HMI and the PLC versions.

The list of possible messages is found in Annex A.

3.8.4 Program screens

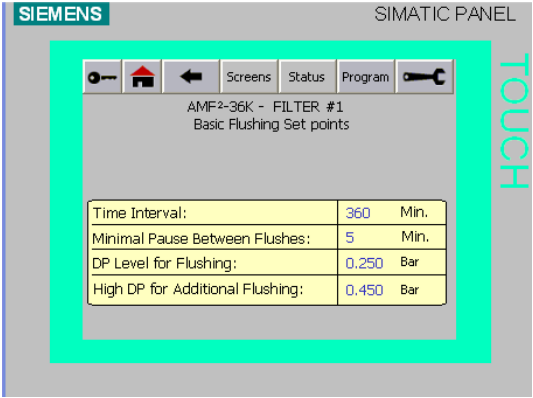
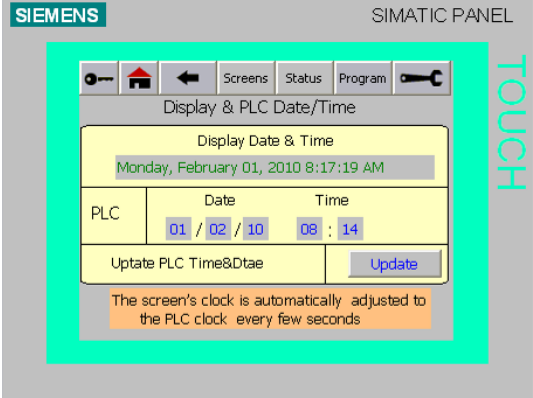
	<p><b>Set points Screen</b></p> <p><b>This screen allows the operator to set the:</b></p> <p><b>Time interval</b> - Set the maximum elapse time between flush cycles. It is recommended that flush cycle will take place at least once every 24 hours [1440 min.]. Enter 9999 for disabling this option.</p> <p><b>Minimum Pause Between Flushes</b> - Set the minimum elapse time between flush cycles. In case of a PD request for flushing within this time, the ALARM lamp turns On. Enter 9999 for disabling this option.</p> <p><b>DP level for Flushing</b> - Set the desired DP value to start flushing. Enter 9999 for disabling this option.</p> <p><b>High DP for Additional Flushing</b> - The desired HDP (High DP) value to start a flush cycle. Enter 9999 for disabling this option.</p>
	<p><b>Time/Date Screen</b></p> <p><b>This screen allows the operator to set the system time:</b></p> <p>There are two clocks in the system: the PLC clock and the HMI clock. The PLC clock has a backup battery and therefore it remains accurate after a power failure.</p> <p>The HMI clock is automatically adjusted to the PLC clock every few seconds.</p> <p>This screen allows the user to set the PLC clock.</p> <p>Enter the correct time and date and press the UPDATE button to update the PLC clock.</p>

### 3.8.5 Tools screens

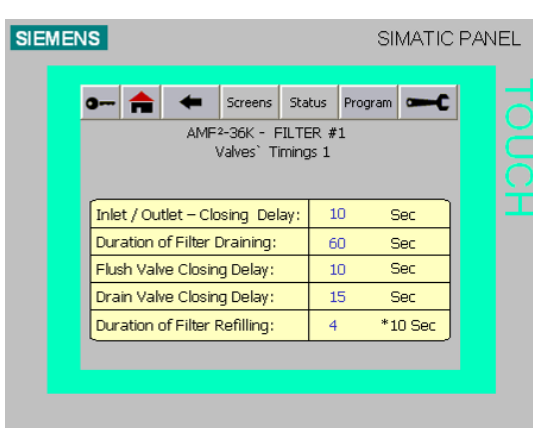
	<p><b>Language Screen</b></p> <p><b>This screen allows the operator to:</b></p> <p>Select the desired HMI language.</p> <p>Press the desired national flag and press OK.</p> <p><b>Note:</b> please refer to chapter 2.5 <b>Changing the HMI language</b> for a complete explanation on the multilingual feature of the HMI system.</p>															
 <table border="1" data-bbox="260 1032 624 1182"> <tr> <td>Inlet / Outlet – Closing Delay:</td> <td>10</td> <td>Sec</td> </tr> <tr> <td>Duration of Filter Draining:</td> <td>60</td> <td>Sec</td> </tr> <tr> <td>Flush Valve Closing Delay:</td> <td>10</td> <td>Sec</td> </tr> <tr> <td>Drain Valve Closing Delay:</td> <td>15</td> <td>Sec</td> </tr> <tr> <td>Duration of Filter Refilling:</td> <td>4</td> <td>*10 Sec</td> </tr> </table>	Inlet / Outlet – Closing Delay:	10	Sec	Duration of Filter Draining:	60	Sec	Flush Valve Closing Delay:	10	Sec	Drain Valve Closing Delay:	15	Sec	Duration of Filter Refilling:	4	*10 Sec	<p><b>Valves 1 Screen</b></p> <p><b>This screen allows the operator to set the:</b></p> <p><b>Inlet / Outlet Closing Delay</b> – Set the delay for closing the inlet and outlet valves. (Default value - 10 seconds.)</p> <p><b>Duration of Filter Draining</b> – Set the time required to completely emptying the filter. (Default value - 60 seconds.)</p> <p><b>Flush Valve Closing Delay</b> – Set the delay for closing the Flush Valve (V5). (Default value - 10 seconds.)</p> <p><b>Drain Valve Closing Delay</b> – The delay for closing the Drain Valve (V4). (Default value - 10 seconds.)</p> <p><b>Duration of Filter Refilling</b> - Set the time required to fill the filter after flushing. (Listen to the noise of the exhaust air in order to determine the end of the filling process). (Default Value - 40 seconds.)</p>
Inlet / Outlet – Closing Delay:	10	Sec														
Duration of Filter Draining:	60	Sec														
Flush Valve Closing Delay:	10	Sec														
Drain Valve Closing Delay:	15	Sec														
Duration of Filter Refilling:	4	*10 Sec														

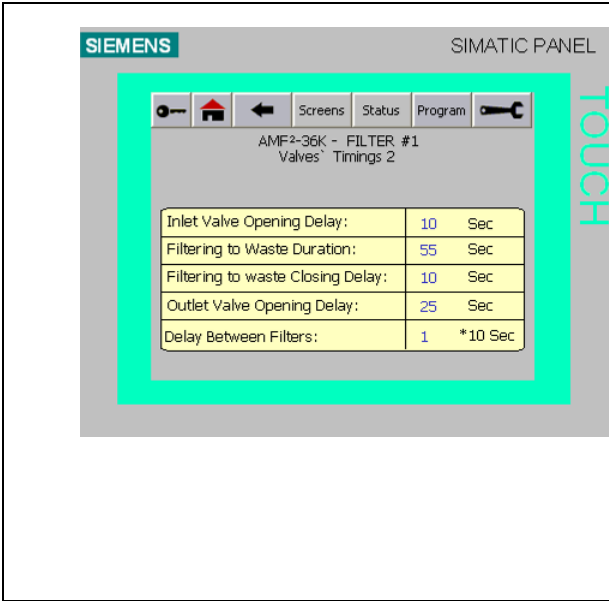

**Valves 2 Screen**

This screen allows the operator to set the:

**Inlet Valve Opening Delay** – Set the delay for opening the inlet valve of the filter. (Default value - 10 seconds.)

**Filtering to Waste Duration** – Set the required time for the “filtering to waste” stage (V7). (Default value - 55 seconds.)

**Filtering to Waste Closing Delay** – Set the required time for closing the “filtering to waste” Valve (V7). (Default value - 10 seconds.)

**Outlet Valve Opening Delay** – Set the delay for opening the outlet valve of the filter. (Default value - 10 seconds.)

**Delay between Filters** - Set the delay in 10 seconds units between the ends of the flush cycle of one unit to the start of the cycle of the next unit. (Default value 1 X 10 seconds.) Not applicable in a single filter installation.

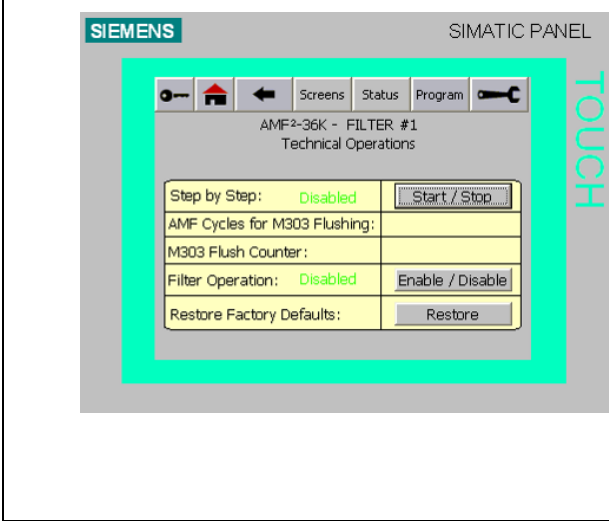

**Operations Screen**

This screen allows the operator to:

**Step by Step** – Start a “Step by Step” back-flush process of the AMF<sup>2</sup> filter.

This is a necessary part of the first startup operation of the filter during its installation process.

**AMF Cycles for M303 Flushing** – N/A in a single AMF<sup>2</sup> 36 filter

**M303 Flush Counter** - N/A in a single AMF<sup>2</sup> 36 filter

**Filter Operation** – Enable / Disable the filter operation. Usually used in multi-filters installation.

**Restore Factory Defaults** - Use this option to reset the system’s parameters to their factory defaults.



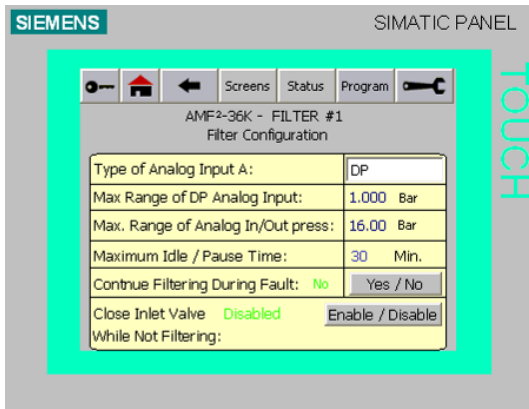

### Configuration Screen – Page 1

This screen allows the operator to set:

**Type of Analog Input A.** – The PLC has 2 analog inputs A & B. This parameter sets the task of Analog Input A. It can be a DP meter or Outlet pressure meter.

**Max. Range of DP Analog Input** – If Analog Input A. is set as a DP then this parameter sets the maximum range of the DP Meter.

**Note:** Since the meter is of 4-20 type, the software assumes that DP of 0 bar is equal to 4 milliamps. So the user has to enter only the maximum DP value for the 20 milliamp reading. Default values are 1 bar or 15 PSI.

**Max. Range of Analog In/Out Press** – If Analog Input A. is set as a DP then Analog Input B. is used as Inlet Pressure meter. This parameter sets the maximum range of the Inlet Pressure Meter.

However if Analog meter A. is not set as a DP meter then Analog Input A. is set as Outlet Pressure and Analog Input B. is set as Inlet pressure.

If the user would like to flush the filter according to a differential Pressure it is necessary to install two pressure meters; Inlet and Outlet. In such case this parameter is used to set the maximum range of the Inlet and the Outlet Pressure Meters. The DP reading in this case is calculated by the software by subtracting the outlet pressure from the inlet pressure.

**Note:** Since the meters are of 4-20 type, the software assumes that Pressure of 0 bar is equal to 4 milliamps. So the user has to enter only the maximum Pressure value for the 20 milliamp reading, i.e. 10 bar, 16 bar, etc.

**Note:** in case of 2 pressure meters they must be of the same type and the same range.

**Maximum Idle / Pause Time** – Set the maximum time for Idle or Pause. This parameter is useful when the filter is filling a tank with the filtered water. When the tank is full the filter enters to pause-mode. In order to ensure that the filter remains clean the user may set a time in this field. In such case if the pause is prolonged, the filter will enter to a flushing cycle once the time entered at this field is exceeded. Enter 9999 for disabling this option.

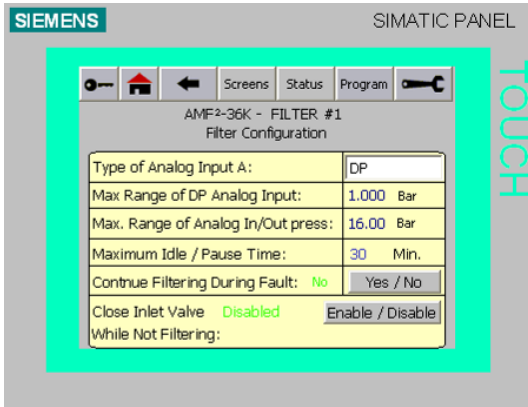

### Configuration Screen – Page 2

This screen allows the operator to set:

**Continue Filtering During Fault** – This parameter sets the filter behavior during fault mode. The user can select to continue the filtering during fault or to stop the filtration by closing the inlet and outlet valves of the filter. Please note that if the filter is faulty and the filtering continues the filter could become totally blocked.

**Close Inlet Valve While not Filtering** – This parameter sets the filter behavior while not filtering (such as in Pause or Idle modes). The user can select to keep the inlet valve in such cases opened or closed.

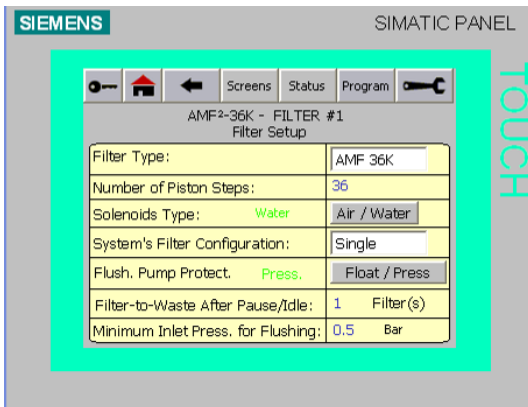

### Setup Screen – Page 1

This screen allows the operator to set:

**Filter Type** – The user may select between AMF<sup>2</sup> 36 or Lab. Test. For normal operation of the filter tis filed **must be AMF<sup>2</sup> 36**.

**Number of Piston Steps** – The user may set the number of piston strokes per flushing cycle. For normal operation of the filter this parameter **must be 36**.

**Solenoid Type** – The user may select the type of solenoids installed at the filter’s solenoids cabinet. **Never set this parameter to the wrong type.**

**System’s Filter Configuration** – If the filter is an independent single filter this parameter should be set to **Single**. However if the filter is part of a multi filters installation this parameter should be set to **Multi**.

**Note:** This HMI Version supports a single installation only

**Flush. Pump Protect.** – The user can set the type of the flushing pump protection device. It can be set to Float or Pressure. The default protection device is a pressure meter installed at the pump’s outlet. However if the pump feeding line is connected to a tank with a tank level float, this parameter should be set to Float.

**Note:** Setting this field to the wrong parameter may cause the filter to cease operation.

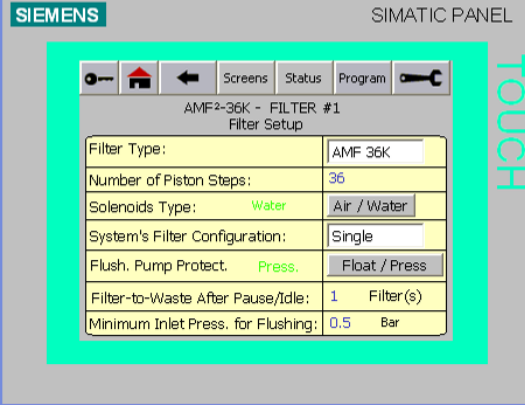

**Setup Screen – Page 2**

**This screen allows the operator to set:**

**Filter-to-waste After Pause / Idle** – This parameter is used to set the number of filters on which a “Filtering to waste” operation should be performed whenever the system exits a Pause or Idle mode. This parameter is used regularly in multi-filter installations and in cases where an extra care is needed in order to ensure the supply of clean water. This action ensures that the filtered water volume that stayed in the filter during the pause/idle period will not reach the consumer.

**Minimum Inlet Press. For Flushing** – This parameter allows the user to set a minimum inlet pressure for sufficient flushing process. This parameter is useful in cases where the filter is flushed with an unstable water source. Entering a value at this field would ensure that the filter is flushed only if there is a sufficient pressure. Enter 9999 for disabling this option.

### 3.9 List of system messages

This chapter lists the system messages divided into their categories:

The following table lists and describes the possible system alarms and attentions messages that may appear on the HMI status screens.

Alarm	Attention	ID	Message Text	Remarks
√		0	No Alarm	
	√	0	No Attention	
√		1	Pump 1 Fault #1	Back-flush pump 1 soft starter fault
	√	2	No Pump Available #2	All the pumps in the system are disabled or in fault mode.
√		3	High DP #3	A flushing cycle triggered by a High DP signal.
√		5	Too Short Time From Last Flushing #5	A requirement for starting a flushing cycle is present while the "Minimum from Last Flush fault" is still counted. (Note: a flushing cycle triggered by the High DP parameter is not affected by this parameter.)
√		6	HDP Alarm #6	The High DP signal is still present after two consecutive flush cycles.
√		7	Low Inlet Pressure #7	The Inlet Pressure is lower than the minimum required for starting a flushing cycle.
√		8	Cycle Stopped #8	A Manual stop of the flush cycle was done
√		9	No Water for Back-flush #9	The flushing water tank is lower than the minimum required for starting a flushing cycle.
√		17	Filter 1 Communication Fault #17	Communication fault between the master controller and filter 1 control board
√		25	No Response Filter 1 #25	No acknowledge from filter 1 to "start flushing" command issued by the master controller
√		33	Filter 1 SW1 & SW2 Both Closed #33	A contradictory faulty indication on the main piston location (probably due to a short circuit).
√		34	Filter 1 SW3 & SW4 Both Closed #34	A contradictory faulty indication on the Index piston location (probably due to a short circuit).
√		36	Filter 1 SW4 Not Found at Startup #36	The Index piston is not locked so the main piston is not allowed to move.
√		37	Filter 1 Piston Movement SW1 to SW2 #37	The main piston started to move from SW1 to SW2 but the movement is not completed. This fault message is issued only after an unsuccessful second trial to push the piston by the controller. In a multi filters installation this is a fault status of the specific filter, since the other filters are still operational the system issues only an alarm message.
√		38	Filter 1 Index Fault #38	The Index piston is not locked. This fault message is issued only after a second trial to push the piston by the controller.
√		39	Filter 1 Index Fault SW4 #39	The emptying process of the filter is completed but the index piston is not locked. (Index SW4)
√		41	Filter 1 Emergency Stop #41	The Stop Button of the filter was pressed during a back-flush cycle.
	√	42	Filter 1 Piston SW1 to SW2 Att. #42	The main piston started to move from SW2 to SW1 but the movement is not completed. This is a system alarm message that is issued during the second trial to push the piston by the filter's controller.
	√	43	Filter 1 Piston SW2 to SW1 Att. #43	The main piston started to move from SW2 to SW1 but the movement is not completed. This is a system alarm message that is issued during the second trial to push the piston by the filter's controller.

	√	44	Filter 1 Index Backward Alarm #44	The Index piston is not unlocked after a forward command. The controller performs a second trial to push the piston and during this trial this alarm message is displayed.
	√	45	Filter 1 Index Forward Att. #45	The Index piston is not locked after a backward command. The controller performs a second trial to push the piston and during this trial this alarm message is displayed.
√		46	Filter 1 Piston Movement SW2 to SW1 #46	The main piston started to move from SW2 to SW1 but the movement is not completed. This fault message is issued only after an unsuccessful second trial to push the piston by the controller. This is a fault status of the specific filter, since the other filter is still operational the system issues only an alarm message.

The following table lists and describes the possible system fault messages that may appear on the controller's status screens.

ID #	Message Text	Remarks
0	No Fault	
1	System Fault #1	All the AMF <sup>2</sup> filters in the system are disabled or in fault mode.
2	No Pump Available #2	The back-flush pumps are in fault mode or in OFF position
4	Low Inlet Pressure #4	The Inlet Pressure is lower than the minimum required for starting a flushing cycle.
5	HDP Fault #5	The differential pressure across the AMF <sup>2</sup> filters exceeds the HDP preset value

## 4. Start-up and First Operation (See page 16-17 for detailed drawings)

In order to achieve maximum performance and smooth operation of the filter it is crucial to perform the Startup and First Operation procedures exactly as described in this section. Please read carefully the following instructions prior to any attempt to operate the filter.

- **Commissioning the filter should be done by an authorized Amiad technician, do not attempt to commission the filter unaccompanied.**
- **Please contact your supplier for coordinating a technician visit.**
- **Failing to coordinate the start-up process with your supplier may lead to undesired damage and may affect your warranty coverage.**

The start-up procedure is a multistage process; the following checklists describe step by step the actions to be done in order to successfully commission the filter:

### 4.1 Dry stage – connections verification

#### Important notes:

**Before starting the dry stage of the filter start-up it is very important to make sure that the filter is empty and isolated from the water system by verifying visually that:**



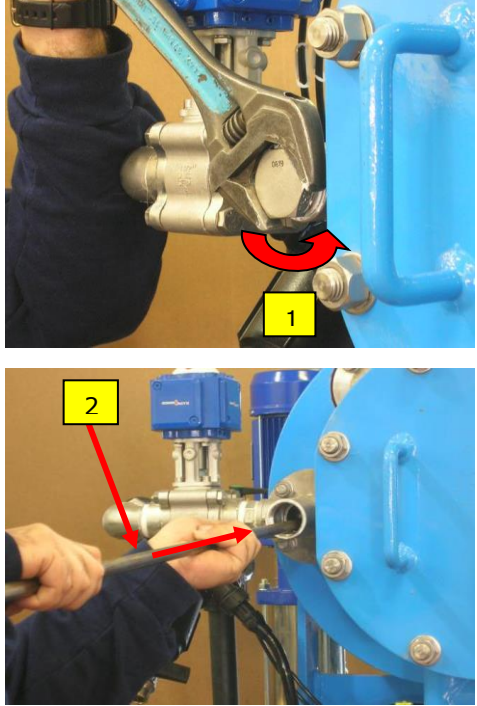

- **The upstream and the downstream manual isolation valves are closed**
- **The flushing water supply line isolation valve is manually closed**

Consult your Certified Installation Arrangement Drawings for these manual valves details.

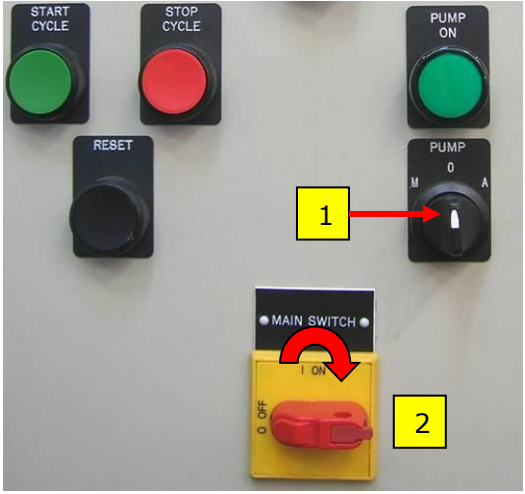
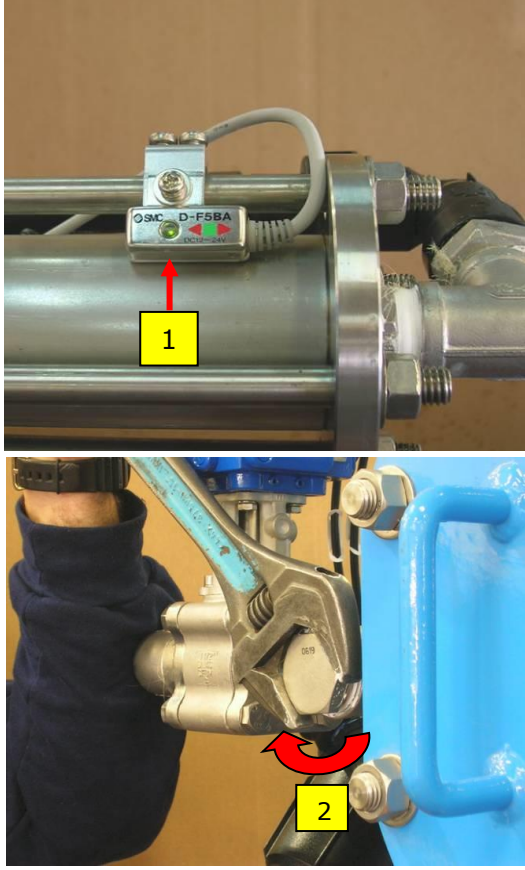
The following checklist lists the actions and the tasks order to be done during the dry stage.

✓	Num.	Action	Picture
	4.1.1	<p><b>Main piston positioning:</b> In order to ensure that the main piston's spray nozzles are not within the cassette package limits, it is necessary to verify that the main piston is at SW1 switch position.</p> <ol style="list-style-type: none"> <li>1. Remove the plug from the piston inlet located at the left side of the cartridge cover.</li> <li>2. Insert a clean and straight 4.5 meter 0.5" pipe or rod through the opened connection (The Tune-up Rod as described at section 2.1.6.).</li> <li>3. Using the rod push the piston all the way in and then remove the rod out of the filter.</li> </ol>	

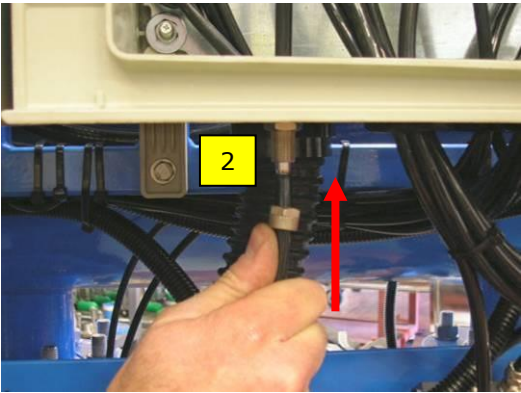
<p>4.1.2</p>	<ol style="list-style-type: none"> <li>1. Make sure that the flushing pump SELECTOR SWITCH is in off position.</li> <li>2. Switch on the power by turning on the MAIN POWER SWITCH.</li> <li>3. Make sure that the POWER ON LAMP and the controller's PANEL are lighted up.</li> </ol>	
<p>4.1.3</p>	<ol style="list-style-type: none"> <li>1. Verify that magnetic switch SW1 led is on. This indicates that the main piston is in the right position.</li> <li>2. Return the plug to its place to and tighten it firmly.</li> </ol> <p><b>If SW1 led is not ON do not proceed and contact your supplier immediately!!!</b></p>	

<p>4.1.4</p>	<p>Valves connection verification: This stage ensures that each one of the filter's valves is connected correctly to the filter's control system.</p> <p><b>Note:</b> The filter's valves are double action pneumatic valves. Their opening status is indicated by a position indicator which is a red arrow marker located on the valve's actuator (See pictures A, B for reference).</p> <ol style="list-style-type: none"> <li>1. Visually check that all the filter's valves are connected to their control tubes.</li> <li>2. Open the door of the solenoids cabinet and switch on the main valve of the pneumatic system in order to supply compressed air to the system.</li> <li>3. Make sure that the manual override handles of all the pneumatic solenoids are at their Automatic position (the indicators are vertical).</li> <li>4. Check the position indicator of each one of the filter's valves and verify that it is pointing to the correct position according to the following list: <ul style="list-style-type: none"> <li>• Inlet Valve – Opened</li> <li>• Outlet Valve – Opened</li> <li>• Drain Valve – Closed</li> <li>• Flushing Valve – Closed</li> <li>• Filter to Waste Valve – Closed</li> </ul> </li> </ol> <p><b>Note:</b> In the rare case where one of the valves is found indicating to the wrong direction, the connections of this valve's two control tubes should be replaced with each other, i.e. the tube that is connected to the Open Port of the valve should be replaced with the tube that is connected to the Close Port of the valve. This will move the valve mechanism and the position indicator will point to the required direction.</p>	<div style="display: flex; justify-content: space-around;"> <div style="text-align: center;"> <p><b>A. Opened</b></p>  </div> <div style="text-align: center;"> <p><b>B. Closed</b></p>  </div> </div>  
--------------	---	--

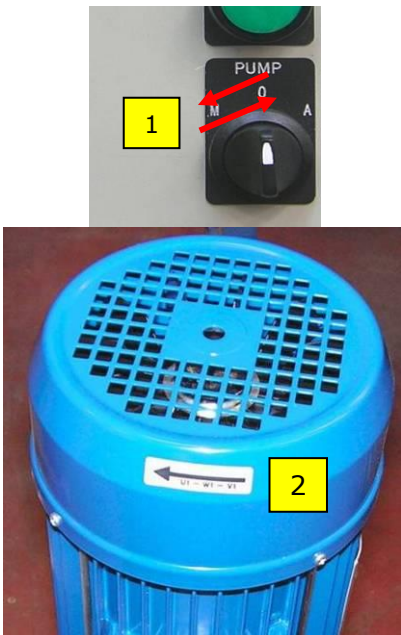

<p>4.1.5</p>	<p>Valves operation verification: This stage ensures that each one of the filter’s valves functions correctly.</p> <p><b>Note:</b> This stage requires two persons to complete, a technician at the solenoids cabinet and an assistant near the valves.</p> <ol style="list-style-type: none"> <li>1. Use a screwdriver to push-in the manual override-handle of each one of the valves’ solenoids for few seconds. This forces the valve to change position (From Open to Closed or vice versa). Release the handle to let the valve return to its original status. Check each one of the valves and make sure that the responding valve is the correct valve as indicated in the following list. Make sure that the valve changes its position during the manual override and returns back to its original position once the solenoid handle is released. <b>Note: Make sure not to turn the handles. They should remain in vertical position.</b></li> </ol> <ul style="list-style-type: none"> <li>• Inlet Valve – Solenoid SV1</li> <li>• Outlet Valve – Solenoid SV6</li> <li>• Drain Valve – Solenoid SV4</li> <li>• Flushing Valve – Solenoid SV5</li> <li>• Filter to Waste – Solenoid SV7</li> </ul> <p>In case that solenoid/valve connections mismatch is found change the control tubing connections between the valves. In such case after the connections change stages 4.1.4 and 3.1.5 should be performed again.</p>	
<p>4.1.6</p>	<p>Flushing Pump rotational direction check: This stage ensures that the flushing pump rotates in the correct direction.</p> <p><b>Note:</b> This stage requires two persons to complete, a technician at the control cabinet and an assistant near the pump.</p> <ol style="list-style-type: none"> <li>1. Turn the flushing pump MANUAL/OFF/AUTO selector switch for <b>one second only</b> to MANUAL position and immediately turn it back to OFF position.</li> <li>2. Check the pump’s rotation direction and make sure that it matches the direction of the arrow on the pump motor cover. If the pump rotates in the wrong direction ask a qualified electrician to correct the direction by changing the connection of two of the phases in the electrical board terminal.</li> </ol>	

## 4.2 Wet stage A. – Initial flushing cycle

### Important notes:

During this stage of the filter’s start-up the filter remains isolated from the process water. The supply line for the following procedures is the flushing water supply line which is the source of clean water used for the filter’s cleaning cycles.

Before starting wet stage A. it is very important to make sure that the filter remains isolated from the Process Water System by verifying visually that the upstream and the downstream manual isolation valves are closed. Consult your Certified Installation Arrangement Drawings for these manual valves details.

The following checklist lists the actions and the order of the tasks to be done during wet stage A.

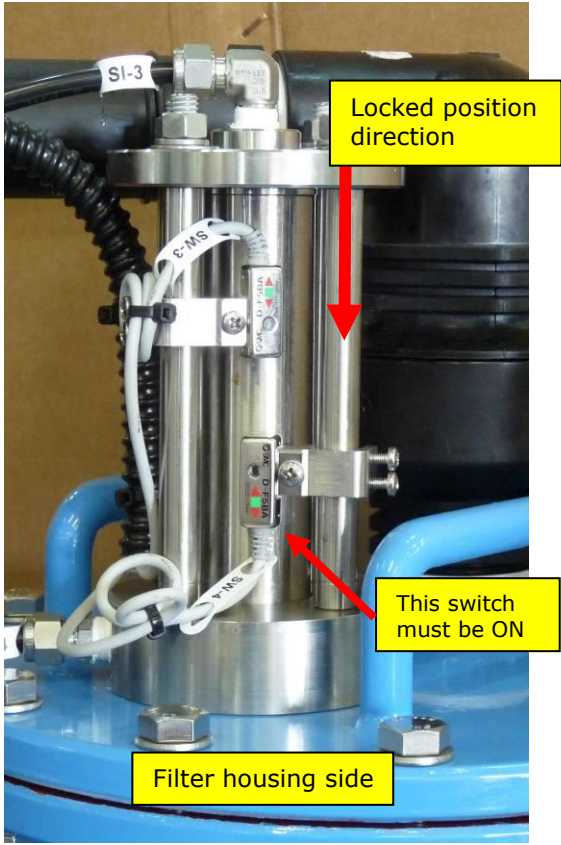
✓	Num.	Action	Picture
	4.2.1	Connecting the filter to the flushing water source: <ol style="list-style-type: none"> <li>1. Open the Manual Isolation Valve of the clean flushing water supply line and check the filter for leaks.</li> <li>2. Make sure that the air release valve is bleeding air from the pump. If not slightly unscrew it, release the trapped air and re-tighten it once a constant flow of water comes out from the port.</li> </ol>	
	4.2.2	Index piston positioning: Ensure that the cassette packages are aligned with the spray nozzles and that the index piston is in its locked position: <ol style="list-style-type: none"> <li>1. Check that the index piston is at SW4 switch position by verifying that the led of switch SW4 is lighted on. This indicates that the piston is locked at the “near to the filter housing” side of the index cylinder.</li> </ol> <p>If the index-piston is not locked at the right position, switch on manually the flushing pump for <b>no more than 2 seconds</b> and then recheck the magnetic switches. <b>You may perform this action only once!</b> If the index piston fails to reach its locked position stop the filter start-up process and contact your supplier.</p> <p><b>If SW4 led is not ON do not proceed and contact your supplier!!!</b></p>	

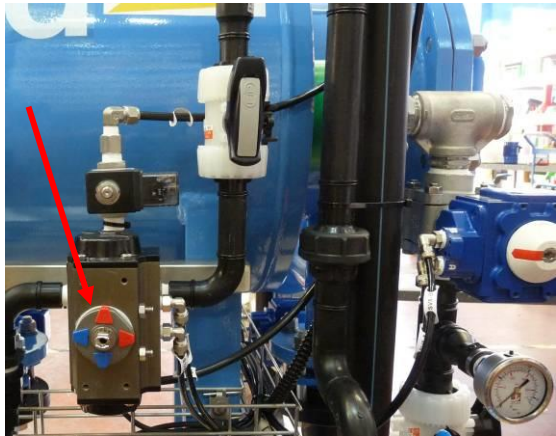
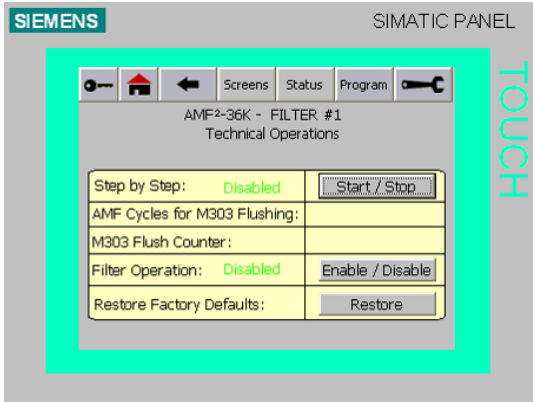
<p>4.2.2.1</p>	<p>Index motion speed calibration:</p> <p><b>Please note:</b> The Index piston speed is pre-calibrated in the factory and only in rare occasions there is a need to recalibrate it. <b>In any case consult your dealer before changing this setting.</b></p>	
<p>4.2.3</p>	<p>Step by step flushing:</p> <p><u>General description:</u> A special step by step operation mode is provided at the filter's control panel to be used during the filter's start up process. (see section 3.4)</p> <ul style="list-style-type: none"> <li>• This mode can be entered through the "Technical Operation" screen of the Tools menu of the HMI panel.</li> <li>• Pressing The Start/Stop button enables this operation mode.</li> <li>• While in this mode the filter moves to the next step each time the Start Pushbutton is pressed.</li> <li>• When a new step starts, the green lamp blinks until the pre-programmed time length of this step is counted down and ended, or until the piston reaches the relevant limit switch. By looking at the countdown data on the screen it is possible to know how much time left to complete the current step.</li> <li>• Once the filter is ready for the next step the lamp stops blinking and remains lighted.</li> <li>• Moving to the next step is possible only when the lamp stops blinking.</li> </ul> <p><u>Steps' groups:</u> The flushing process consists of a large number of steps. These steps can be combined to 3 major groups:</p> <ol style="list-style-type: none"> <li>1. Flushing Initiation group – Steps that prepare the filter to the actual cleaning of the cartridges.</li> <li>2. Cartridges' Cleaning group – A set of repetitive steps that are involved in the actual movement of the spray nozzles along the 36 cassette rows of the cartridge.</li> <li>3. End of Flushing group – Steps that end the flushing process and return the filter to filtration mode.</li> </ol>	

Actions to be done during the step by step operation:

Start the step by step process as described in the general section of this paragraph and run through the process from start to end.

1. Monitor the progress of each step closely and verify that it starts and stops correctly.
2. Make sure that the discharge pressure of the flushing pump is 10 bars. If the pressure does not meet this level do not continue the step by step process and check the pump for malfunctions such as: wrong rotation direction, insufficient air bleeding, insufficient water supply, Opened bypass valve, etc.

**Note: the pump's bypass valve must remain closed at all times (A), you may open it slightly only if the pressure during flushing is higher than 10 bars.**

**Check the pressure at pressure meter (B) on the very beginning of the flushing process before the piston movement starts. If the pressure is higher than 10 bar use the bypass to calibrate it. Make sure that the bypass valve remains closed if the pressure is 10 bar or less.**

3. During the Cartridges' Cleaning steps use the 2 adjustment ball valves located at the controlled manifold to set the main piston movement speed to 9-10 seconds in each direction.

**If any malfunction is encountered during the step by step process stop the operation and contact your supplier!**

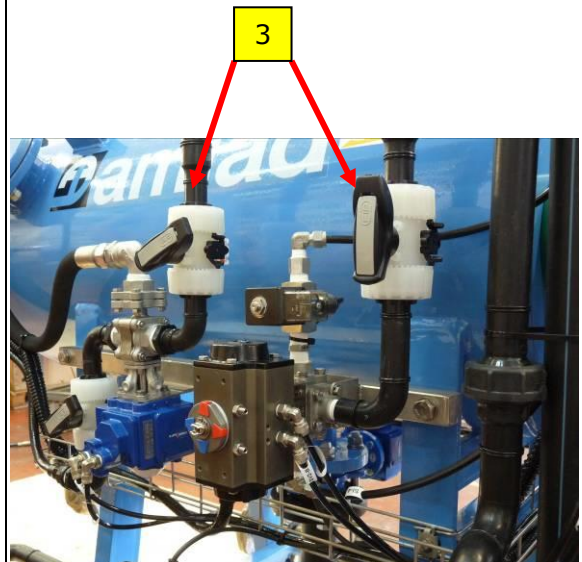
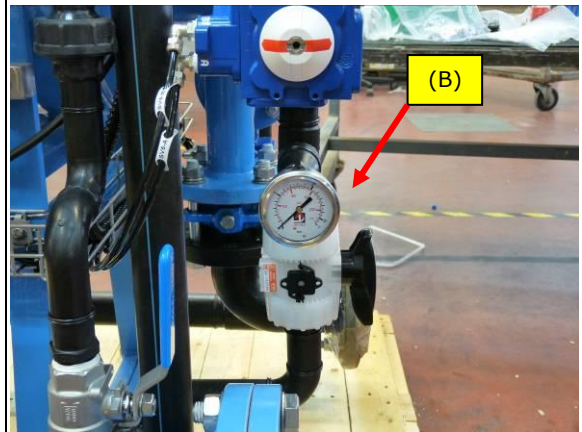
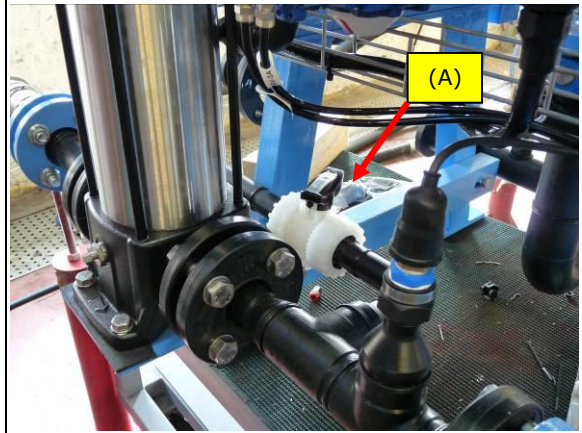

### 4.3 Wet stage B. – First filtration cycle

**Important notes:**

**In this stage the filter’s starts the actual filtration of the process water.**

The following checklist lists the actions and the order of the tasks to be done during wet stage B.

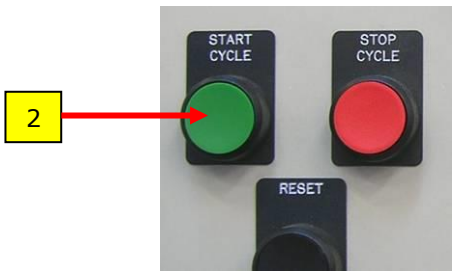
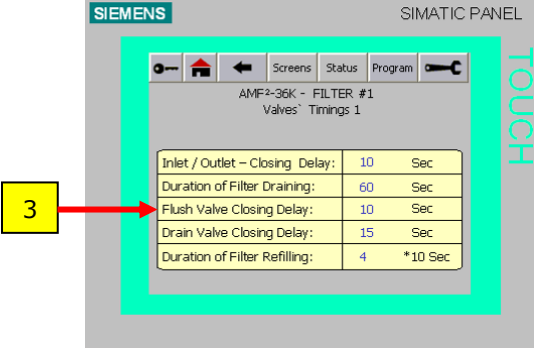
✓	Num.	Action	Picture
	4.3.1	<p>Connecting the filter to the process water system:</p> <ol style="list-style-type: none"> <li>1. Open gradually and slowly the Inlet Manual Isolation Valve (the upstream valve) and let the unfiltered process water to enter the filter. Consult your Certified Installation Arrangement Drawings for this manual valve details.</li> <li>2. During the filling process of the filter check the air release valve and make sure that air is released from the filter.</li> <li>3. Open gradually and slowly the Outlet Manual Isolation Valve (the downstream valve). The filter starts to filter the process water.</li> <li>4. Check the filter for general leakages and fix any leak found.</li> </ol>	
	4.3.2	<p>First complete flushing process:</p> <ol style="list-style-type: none"> <li>1. Let the filter work and filter the process water for about an hour.</li> <li>2. Initiate a flushing cycle by pressing the START CYCLE push button on the control cabinet door.</li> <li>3. Monitor the emptying process of the filter during the Flushing Initiation Steps and verify that by the time the high pressure flushing valve is opened the filter housing is already empty. If the time setting is too short for completely emptying the filter increase the number at the Open Drain Time parameter on the 4<sup>th</sup> screen of the F2 menu in the control panel. <b>Note:</b> - it is possible to set a longer time than the 2.5 minutes default value but <b>it is not allowed to shorten the factory default.</b></li> </ol>	 

Once the wet stage B. procedure is correctly completed the filter is up and running.

## 5. Technical Specifications

### 5.1 Standard AMF 36K Specifications

<b>Technical Specifications:</b>	
Filtration Degree	3,7,10,20 micron
Flange connections	2" Inlet/Outlet, 2" Drain PN10
Maximum Working Pressure	10 bar
Design Pressure	10 bar
Maximum Working Temperature	40 degree C
Filtration Area	35600 cm2
Filtration Element	350 Cassette Units
Inlet/ Outlet Valves	2" Pneumatically Actuated Butterfly Valve
Drain Valve	2" Pneumatically Actuated Butterfly Valve
Outlet Drain Valve	2" Pneumatically Actuated Butterfly Valve
Drain Valve	2" Manually Operated
Flush Valve	1 ¼" Pneumatically Actuated Ball Valve (Full Bore)
Flush Pump Flow	6 m3/h
Flush Pump Discharge Pressure	10 bar
Flush Pump Power	Maximum 3 Kw
Net Flush Cycle	6-8 minutes
Flush Water Quantity per Flush	0.6 m3/flush cycle
Weight Empty	480 kg
Weight Full of Water	680 kg

<b>Installation Requirements:</b>	
Pump Electrical Supply Maximum 4 Kw	3 phase/220-400 volt/ 50 Hz or 240-460 volt/60 Hz, other 3 phase supplies by request
Control Electrical Supply Maximum 0.5 Kw	1 phase/ 100 - 240 volt/ 50 or 60 Hz
Compressed Air Supply	6 bar, dry and lubricated
Drainage Facilities	Gravity Flow 0.6 m3/cycle of 36 counts
Flushing water source	Filtered water from filtered water tank
<b>Construction Materials:</b>	
Filter Housing and Covers	Epoxy coated carbon steel
Cassette	Polyester thread on plastic body
Cleaning mechanism	316L St/St and plastic
Exhaust Valves	Cast Iron, EPDM, Brass, St/St
Ball Valve	St/St, PTFE
Seals	N.B.R
Pressure Hoses	Rubber

## 5.2 Solenoids' drawing

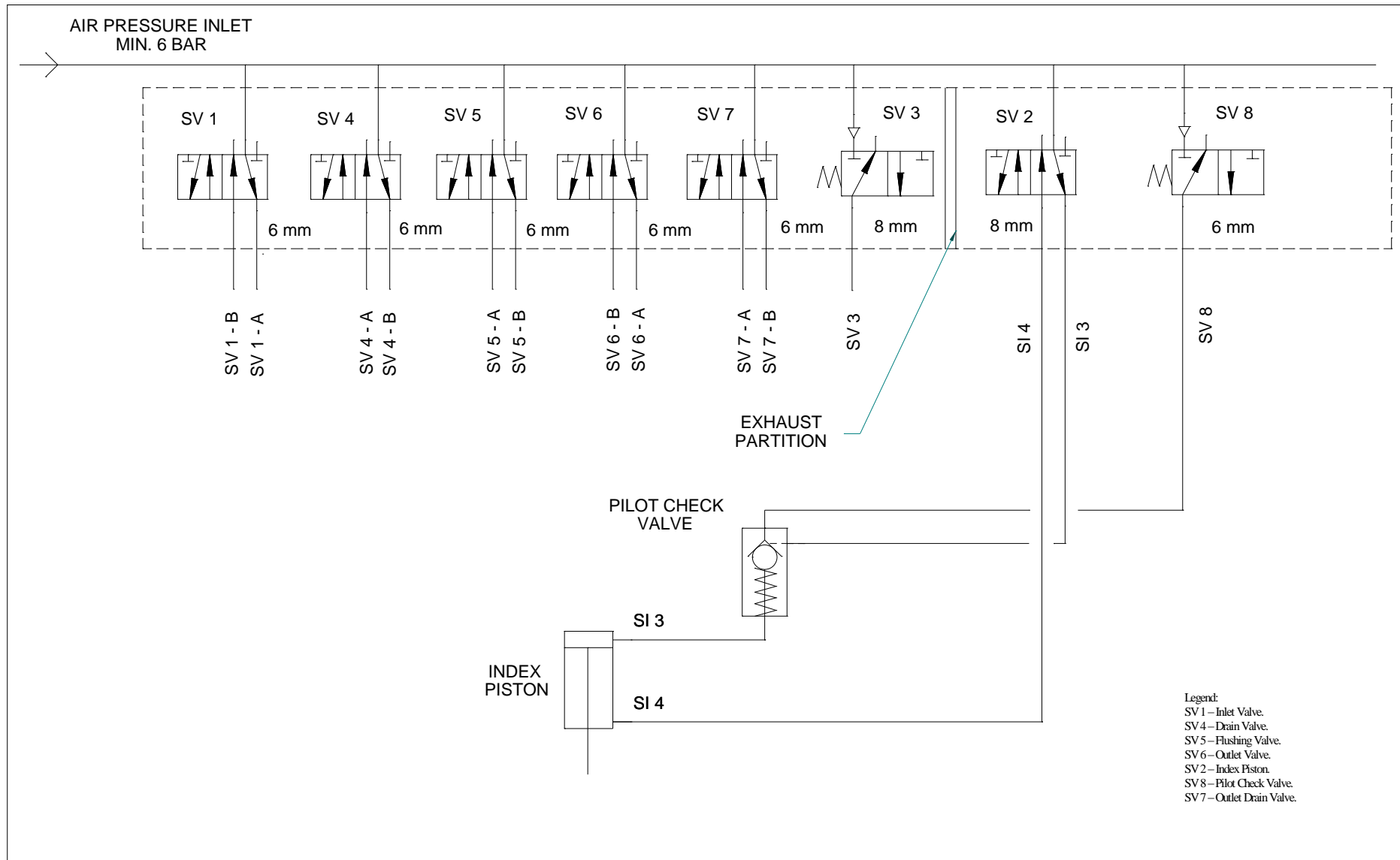



### 5.3 Control cabinet drawings:

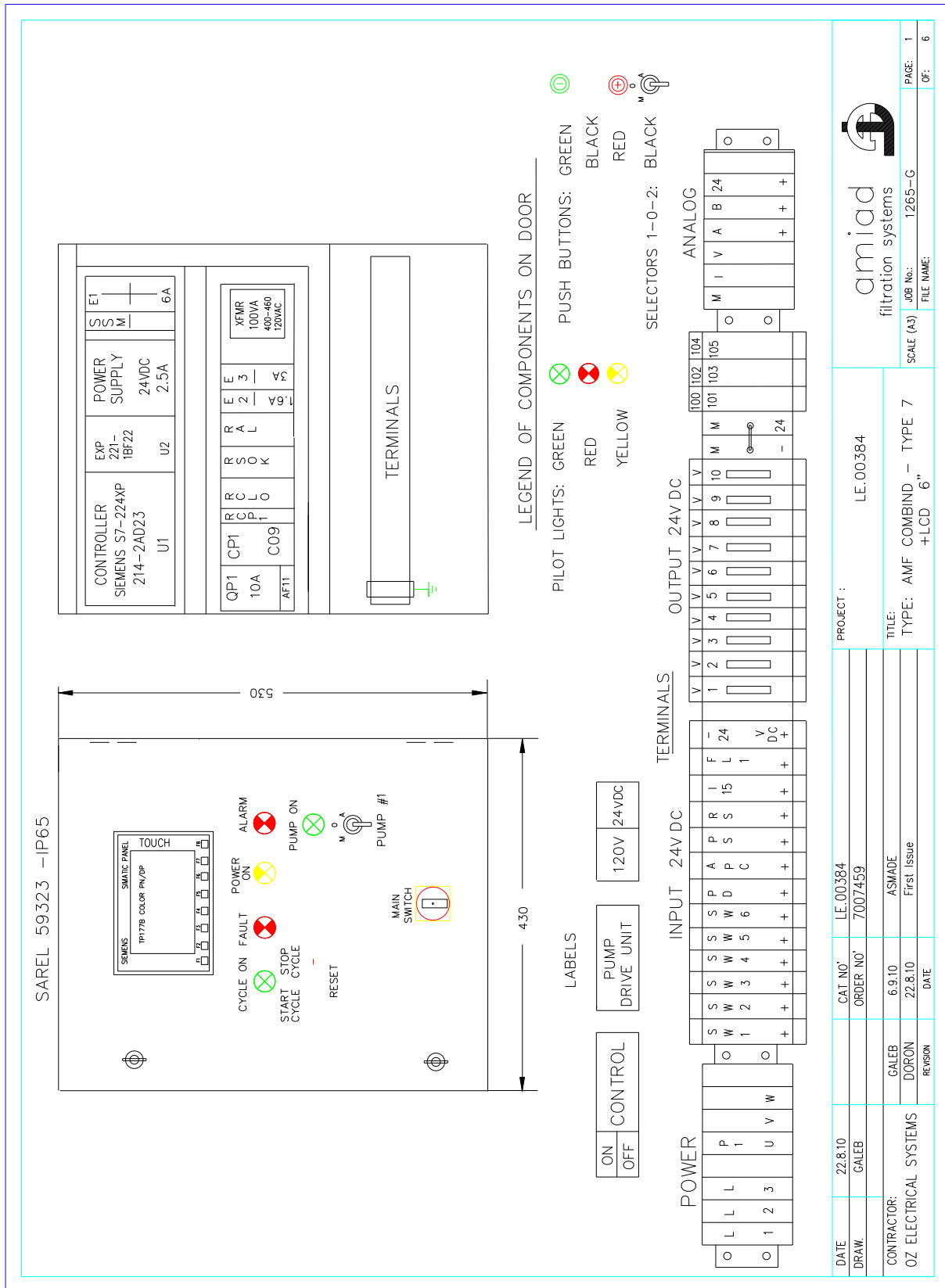

DATE	22.8.10	CAT NO'	LE.00384	PROJECT :	LE.00384	filtration systems	PAGE: 1	
DRAW	GALEB	ORDER NO'	7007459				SCALE (A3)	JOB No.: 1265-G
CONTRACTOR:		GALEB	6.9.10	TITLE:	AMF COMBIND – TYPE 7			OF: 6
OZ ELECTRICAL SYSTEMS		DORON	22.8.10	TYPE:	AMF COMBIND – TYPE 7			
		REVISION	DATE		+LCD 6"		FILE NAME:	

**AMF² 36K + HMI**

08.2013

[www.amiad.com](http://www.amiad.com)

Page 65 of 71

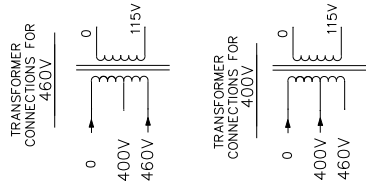
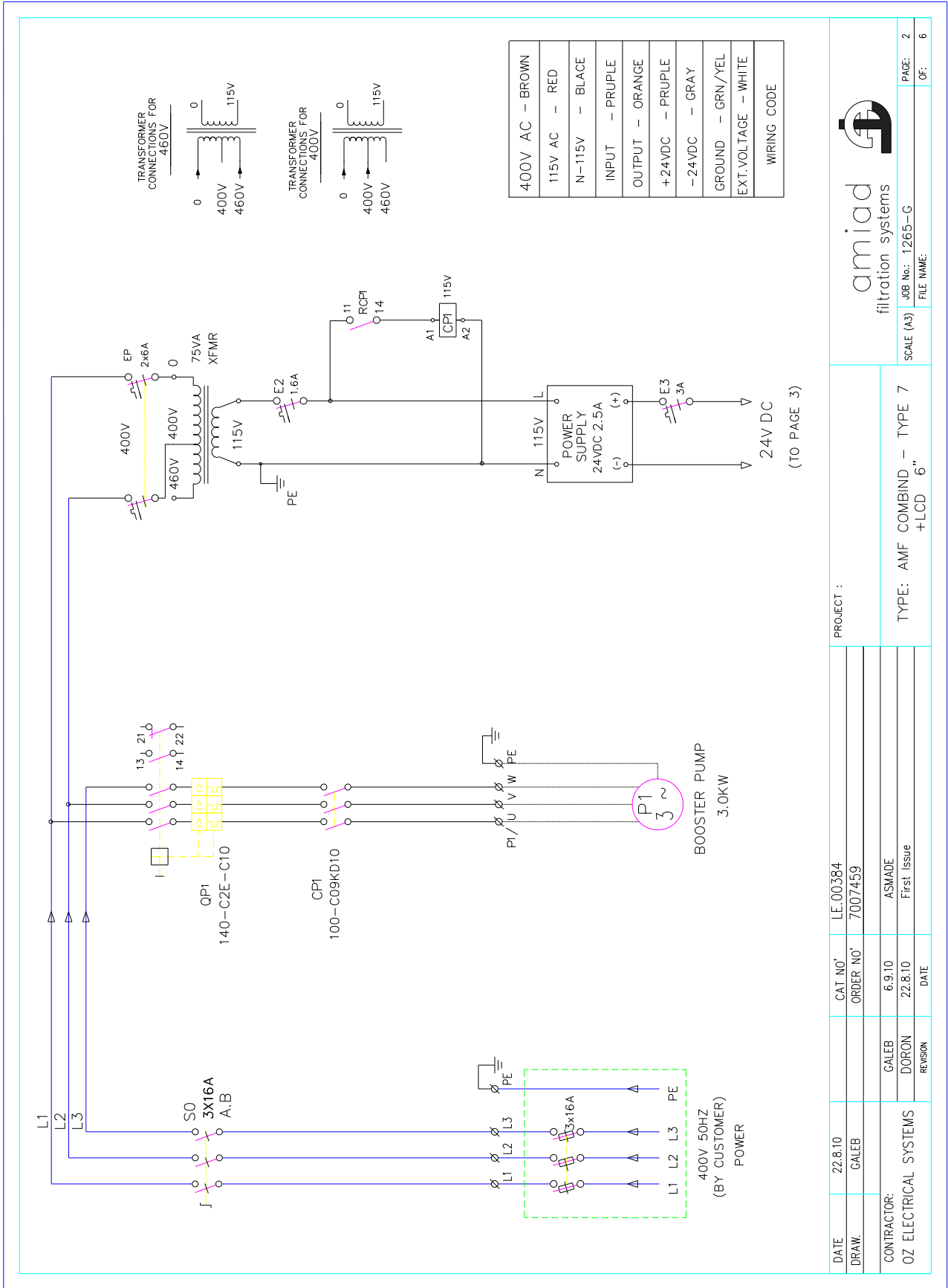

400V AC	– BROWN
115V AC	– RED
N-115V	– BLACE
INPUT	– PRUPLE
OUTPUT	– ORANGE
+24VDC	– PRUPLE
–24VDC	– GRAY
GROUND	– GRN/YEL
EXT. VOLTAGE	– WHITE
WIRING CODE	



amiad  
filtration systems

DATE	22.8.10	CAT NO'	LE.00384	PROJECT :	
DRAW	GALEB	ORDER NO'	7007459		
CONTRACTOR:	GALEB	6.9.10	ASWAD	TYPE: AMF COMBIND – TYPE 7 +LCD 6"	SCALE (A3)
	DORON	22.8.10	First issue		
OZ ELECTRICAL SYSTEMS	REVISION	DATE		FILE NAME:	
					PAGE: 2
					OF: 6

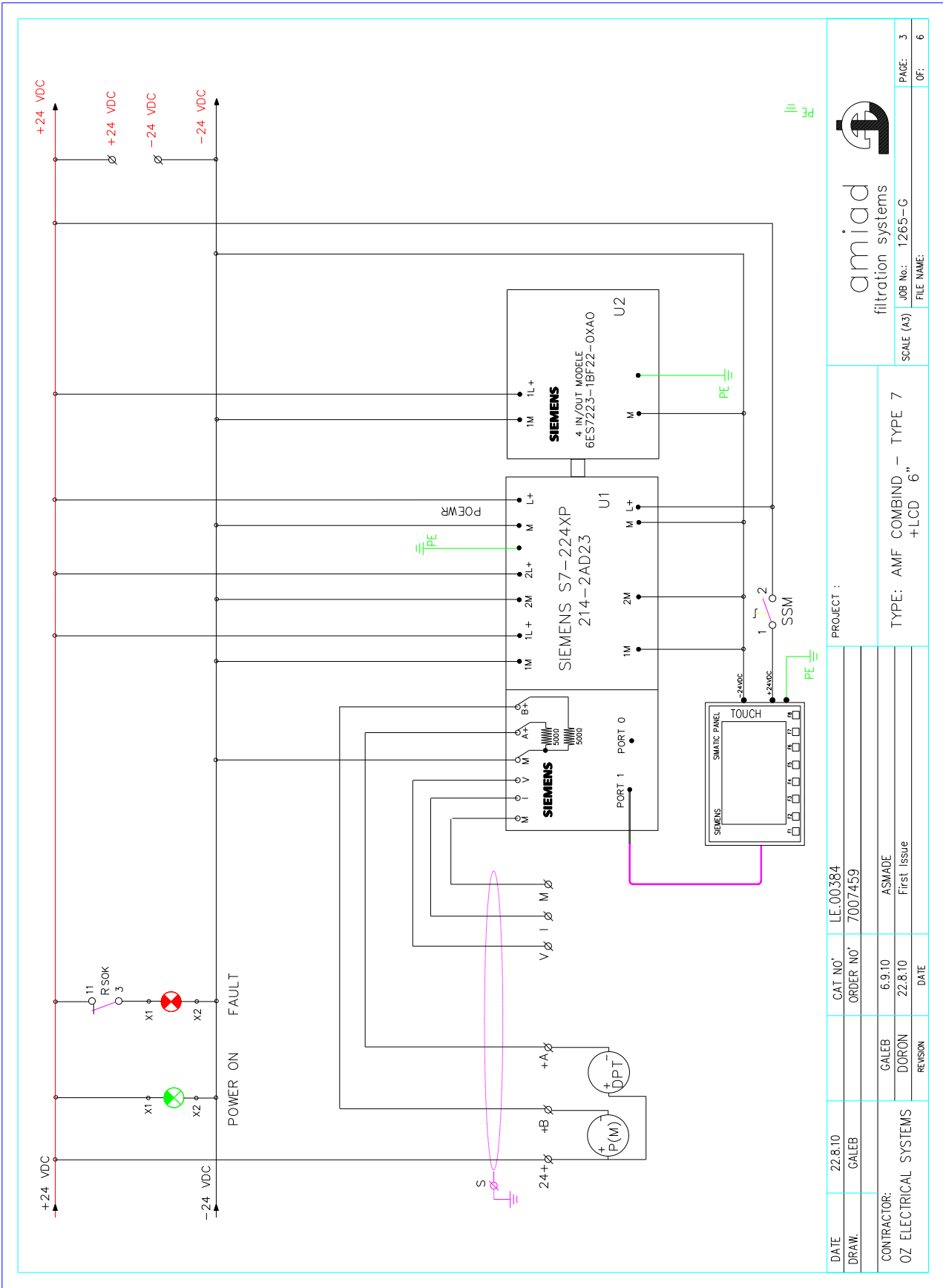

DATE	22.8.10	CAT NO'	LE.00384	PROJECT :	amiad filtration systems			SCALE (A3)	JOB No.: 1265-G	PAGE:	3
DRAW:	GALEB	ORDER NO'	7007459					FILE NAME:		OF:	6
CONTRACTOR:		GALEB	6.9.10	TYPE: AMF COMBIND - TYPE 7							
OZ ELECTRICAL SYSTEMS		DORON	22.8.10	+LCD 6"							
		REVISION									

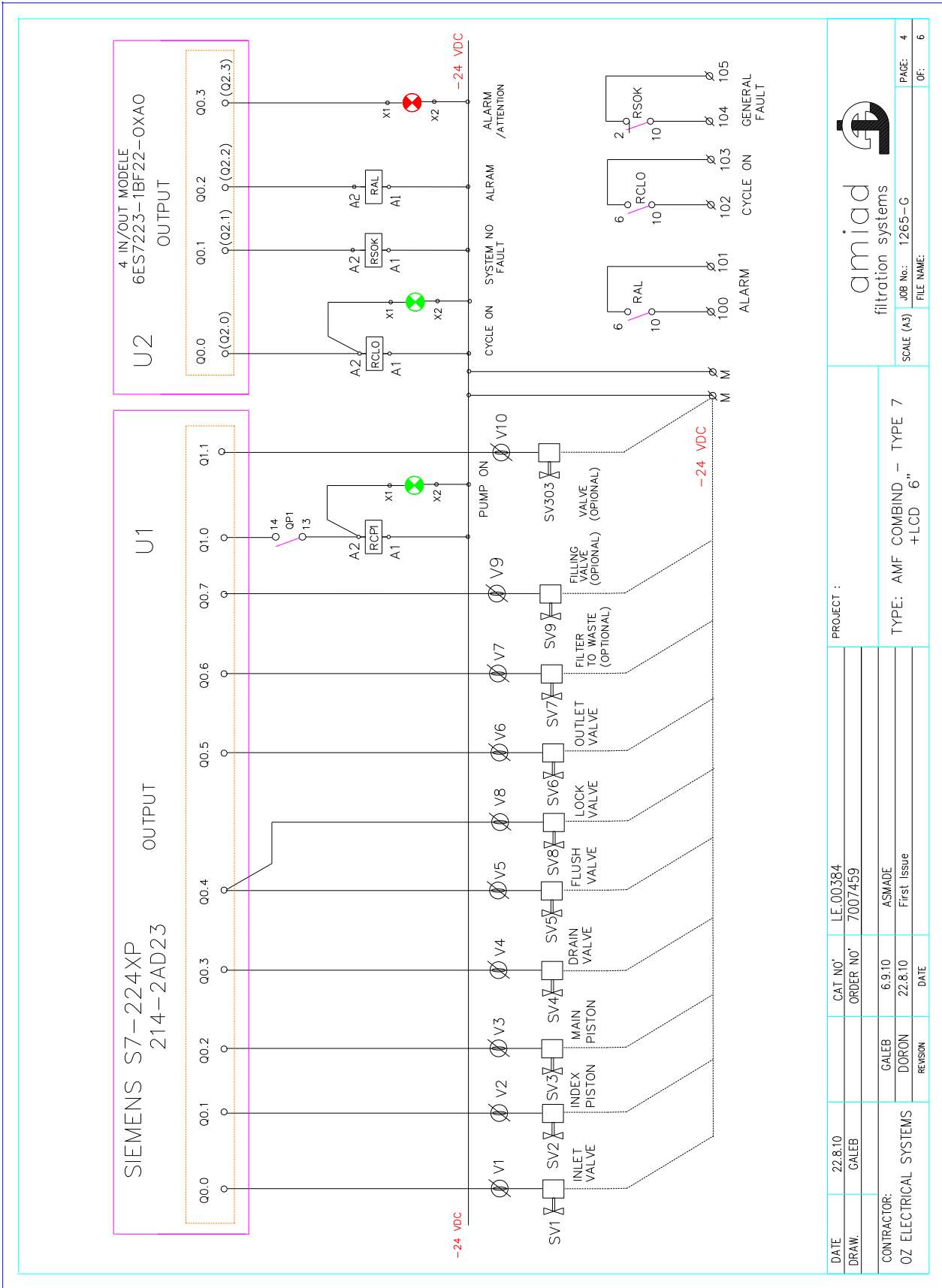

PROJECT :	
DATE	22.8.10
DRAW	GALEB
CONTRACTOR:	
GALEB	6.9.10
DORON	22.8.10
REVISION	DATE
ASMADE	First Issue
OZ ELECTRICAL SYSTEMS	
CAT NO'	LE.00384
ORDER NO'	7007459
TYPE: AMF COMBIND - TYPE 7 +LCD 6"	
SCALE (A3) JOB No.: 1265-G	
FILE NAME:	
PAGE: 4	OF: 6

amiad filtration systems	
PROJECT :	
DATE	22.8.10
DRAW	GALEB
CONTRACTOR:	
GALEB	6.9.10
DORON	22.8.10
REVISION	DATE
ASMADE	First Issue
OZ ELECTRICAL SYSTEMS	
CAT NO'	LE.00384
ORDER NO'	7007459
TYPE: AMF COMBIND - TYPE 7 +LCD 6"	
SCALE (A3) JOB No.: 1265-G	
FILE NAME:	
PAGE: 4	OF: 6

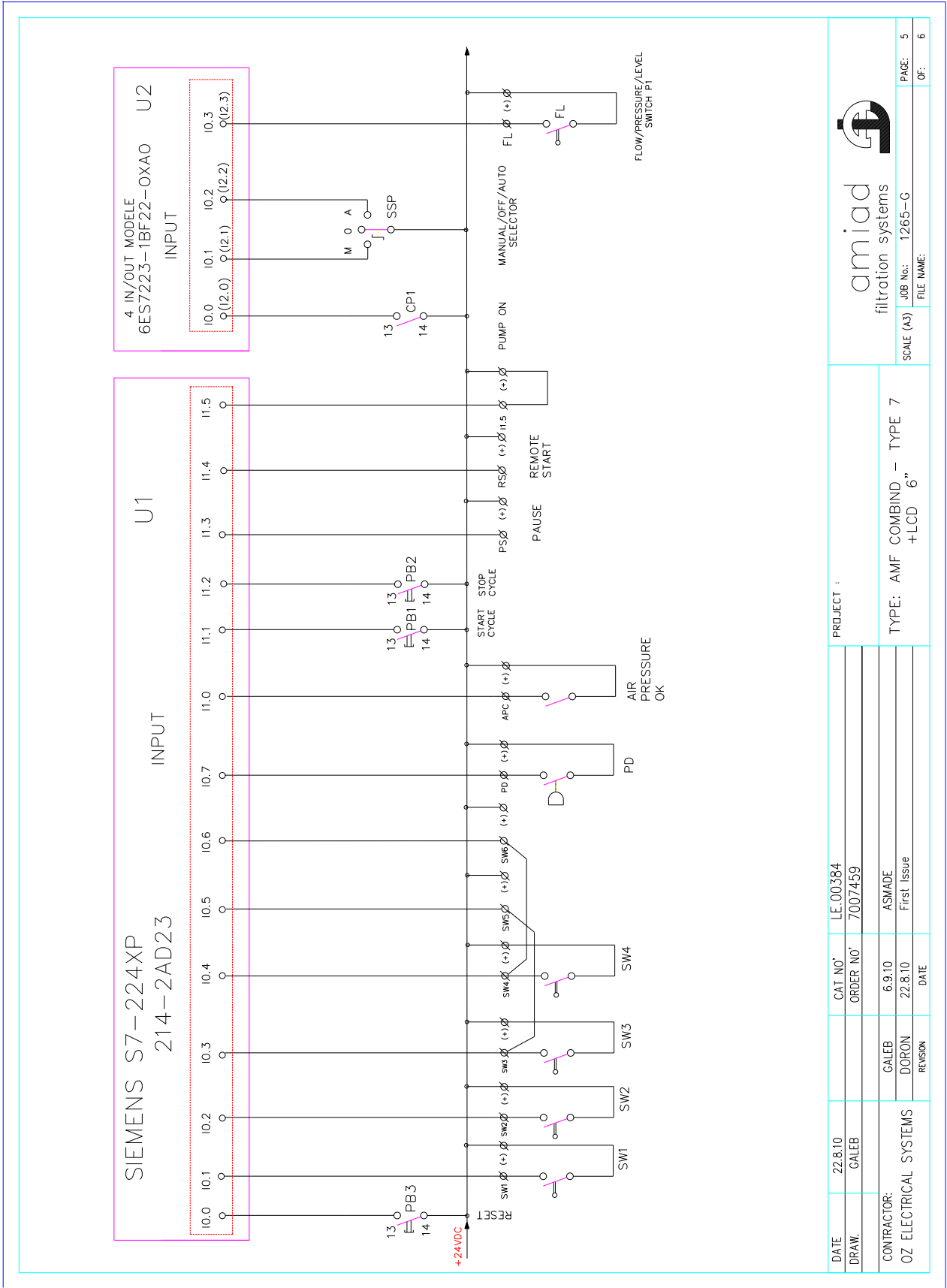

PROJECT :	
DATE	22.8.10
DRAW.	GALEB
CONTRACTOR:	
OZ ELECTRICAL SYSTEMS	GALEB
	DORON
	REVISION
CAT NO'	LE.00384
ORDER NO'	7007459
	6.9.10
	ASWADE
	22.8.10
	First Issue
TYPE: AMF COMBIND - TYPE 7 +LCD 6"	
SCALE (A3)	JOB No.: 1265-G
	FILE NAME:
PAGE: 5	OF: 6

PROJECT :	
DATE	22.8.10
DRAW.	GALEB
CONTRACTOR:	
OZ ELECTRICAL SYSTEMS	GALEB
	DORON
	REVISION
CAT NO'	LE.00384
ORDER NO'	7007459
	6.9.10
	ASWADE
	22.8.10
	First Issue
TYPE: AMF COMBIND - TYPE 7 +LCD 6"	
SCALE (A3)	JOB No.: 1265-G
	FILE NAME:
PAGE: 5	OF: 6

ITEM	QTY	MANUFACTURE	TYPE	DESCRIPTION
26	-	GENIUS	H05 V-K	WIRES
25	-	PHOENIX	UK5N/UKK5- #4	TERMINAL
24	10	PHOENIX	24VDC 1A UK5-HES1	FUSE
23	4	ABB	CR-PLS-10A	BASE
22	4	ABB	CR-PO24DC2-24VDC	RELAY
21	1	LAMBDA	24VDC dpp30-24 2.5A	POWER SUPPLY
20	1	SIEMENS	972-0BA41	BUSCONNECTOR
19	1	SIEMENS	972-0AA41	BUSCONNECTOR +PG
18	1	SIEMENS	EXP-223-1BF22	EXP CONT
17	1	SIEMENS	S7-224XP-2AD23	CPU MODULE
16	6	SIEMENS	TP177B	CONTROL PANEL
15	1	ALLEN BRADLEY	100-C09K010 4KW	CONTACTOR
14	1	ALLEN BRADLEY	140-C2E-C10+A11	MOTOR PROTECTION
13	1	HULDA	460-400/120V	TRANSFORMER
12	1	ABB	E221-10 (0-1)	SELECTOR SWITCH
11	2	SALZER	PL16-22D (Green)	PILOT LIGHT
10	2	SALZER	PL16-22D (Red)	PILOT LIGHT
9	1	SALZER	PL16-22D (Yellow)	PILOT LIGHT
8	1	ABB	CP-10C-10	PUSH BUTTONS (Green)
7	1	ABB	CP-10C-10	PUSH BUTTONS (Green)
6	1	ABB	CP-10B-10	PUSH BUTTONS (Black)
5	1	ABB	C3SSI-10B-20	SELECTORS 1-0-2
4	1	ABB	194L-E16-1753	SWITCH DISCONNECTOR
3	1	ABB	S951N C6 2X6A	CIRCUIT BREAKER
2	2	ABB	S201MC3-1.6 1x3/1.6A	CIRCUIT BREAKER
1	1	SAREL	59323	ENCLOSURE+METAL PLATE

BILL OF MATERIAL

PROJECT :  
 CAT NO' LE.00384  
 ORDER NO' 7007459  
 CONTRACTOR: GALEB 6.9.10 ASMADE  
 OZ ELECTRICAL SYSTEMS DORON 22.8.10 First Issue  
 TYPE: AMF COMBIND - TYPE 7  
 +LCD 6"

DATE	22.8.10	CAT NO'	LE.00384
DRAW.	GALEB	ORDER NO'	7007459
CONTRACTOR:	GALEB	DATE	22.8.10
OZ ELECTRICAL SYSTEMS	DORON	REVISION	First Issue

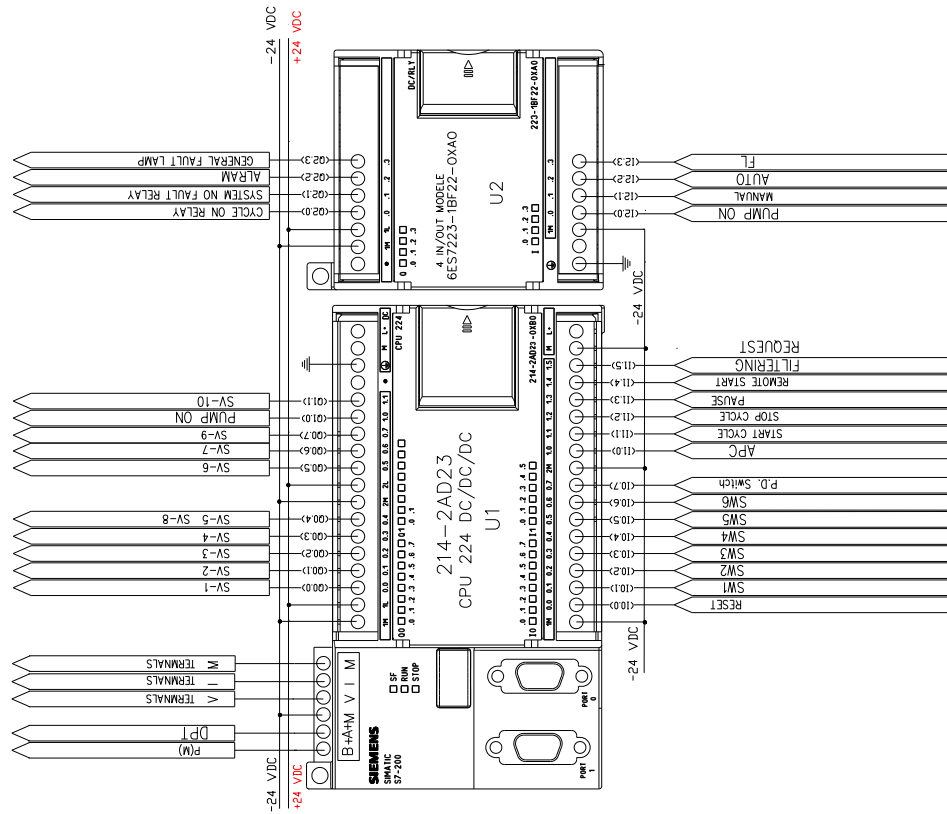

## AMIAD LIMITED WARRANTY

This certificate applies to Amiad Products purchased by You from Amiad or an Amiad authorized Distributor ("Distributor"). This limited warranty extends only to the original purchaser, and is not transferable to anyone who subsequently purchases, leases, or otherwise obtains the Product from the original purchaser.

1. Amiad hereby warrants that the Products are and will be free from defects in material and workmanship under normal use and service. Amiad warrants that it will correct manufacturing defects in the Products, in accordance with the conditions set out in this warranty.
2. This warranty is enforceable for a period of 12 months after the date Bill of Lading or equivalent (the "Warranty Period").
3. In the event that during the Warranty Period the Distributor discovers a defect in material and/or workmanship in any Product or part (the "Defective Product"), it shall submit a written complaint to Amiad using Amiad's standard customer complaint form. For the receipt of the customer complaint form, the submission of the complaint or any questions please contact your customer service representative.
4. Upon written demand by Amiad the Distributor shall return the Defective Products – or a sample thereof – to Amiad, at Amiad's cost. If the customer ships any such Product, Amiad suggests the customer package it securely and insure it for value, as Amiad assumes no liability for any loss or damage occurring during shipment. Provided however that in the event Amiad determines that the warranty does not apply to such Product, Distributor shall promptly reimburse Amiad for such cost (including freight and customs). Any returned Product or part must be accompanied by the warranty certificate and the purchase invoice. It is clarified that the Distributor may not return the Defective Product unless such return was coordinate and approved by Amiad in advance.
5. Amiad's obligation under this warranty shall be limited to, at its option, the repair or exchange, free of charge, of the Product or any part which may prove defective under normal use and service during the Warranty Period. The provision of a repaired or replacement Product during the Warranty Period will result in an extension of the Warranty Period by an additional period of 12 months, provided that the total accumulated Warranty Period shall in any event be no more than 18 months from the original Bill of Lading.
6. This warranty is valid on the condition that the Products are installed according to Amiad's instructions as expressed in Amiad's instruction manuals and according to the technical limitations as stipulated in Amiad's literature or as stated by a representative of Amiad.
7. This warranty will not apply to damaged or defective Products resulting from or related to:
  - (i) Fire, flood, power surges or failures or any other catastrophe/and or unforeseen occurrence, such as but not limited to those for which the customers are customarily insured;
  - (ii) Fault, abuse or negligence of the customer;
  - (iii) Customer's responsibilities, including the failure of the intake water to meet the agreed standards, as set forth in a written document, approved by Amiad or improper storage.
  - (iv) Improper or unauthorized use of the Product or related parts by the customer, including the customer's failure to operate the Product in conformity with the recommendations and instructions of Amiad, as set forth in Amiad's manuals and other written materials, the operation of the Product other than by a trained and qualified operator, or improper installation of the Product by a third party not authorized by Amiad;
  - (v) Performance by the customer of maintenance and other services other than by a trained and qualified advanced operator, or other than in conformity with the recommendations and instructions of Amiad, or other than in accordance with procedures defined in the literature supplied for Products;
  - (vi) Any alteration, modification foreign attachment to or repair of the Products, other than by Amiad or its authorized technical representatives.
8. In no event shall Amiad be liable to the customer or any third party for any damages, including indirect, special, exemplary, punitive or consequential damages, or lost profits arising out of or in connection with this warranty, or arising out of or in connection with the Product's performance or failure to perform, even if it has been advised of the possibility of such damages.
9. Amiad will be excused for failure to perform or for delay in performance hereunder if such failure or delay is due to causes beyond its reasonable control or force majeure preventing or hindering performance.
10. The limited warranty set forth herein is the only warranty given by Amiad and is provided in lieu of any other warranties created by any documentation, packaging or otherwise.
11. Amiad makes no warranty whatsoever in respect of accessories or parts not supplied by Amiad. In the event that Amiad is required to correct a defective Product or product not covered by this warranty, it will do so solely in consideration for additional fees.