

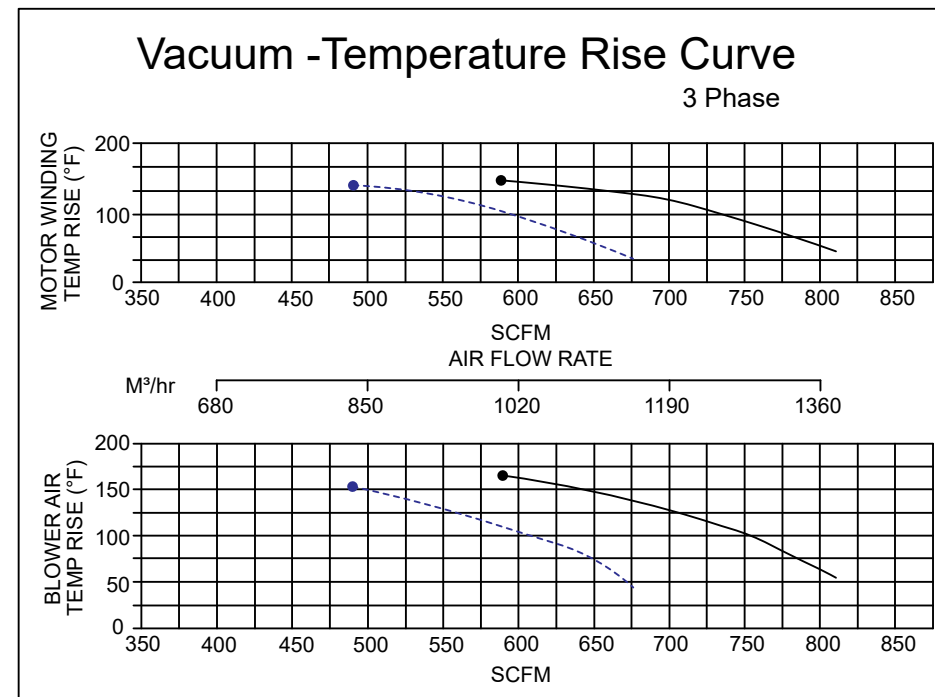

Phase	Model Number	Curve Number	Frequency (Hz)	KW	HP	Max Flow (SCFM)	Max Pressure ("H ₂ O)	Max Vacuum ("H ₂ O)	Sound Level (dB)	Inlet/Outlet Diameter (Inches)	Voltage	Current (A)	Weight (lbs)
3	AB-1902	A128	60Hz	29.00	40.00	812	185	177	84	4.00"	220-275/380-480	92.0Δ/53.2Y	443
			50Hz	25.00	33.50	677	128	123	80		200-240/345-415	88.5Δ/51.0Y	

**Sound db measured at 3ft.

MODEL NO. : AB-1902 DOUBLE STAGE

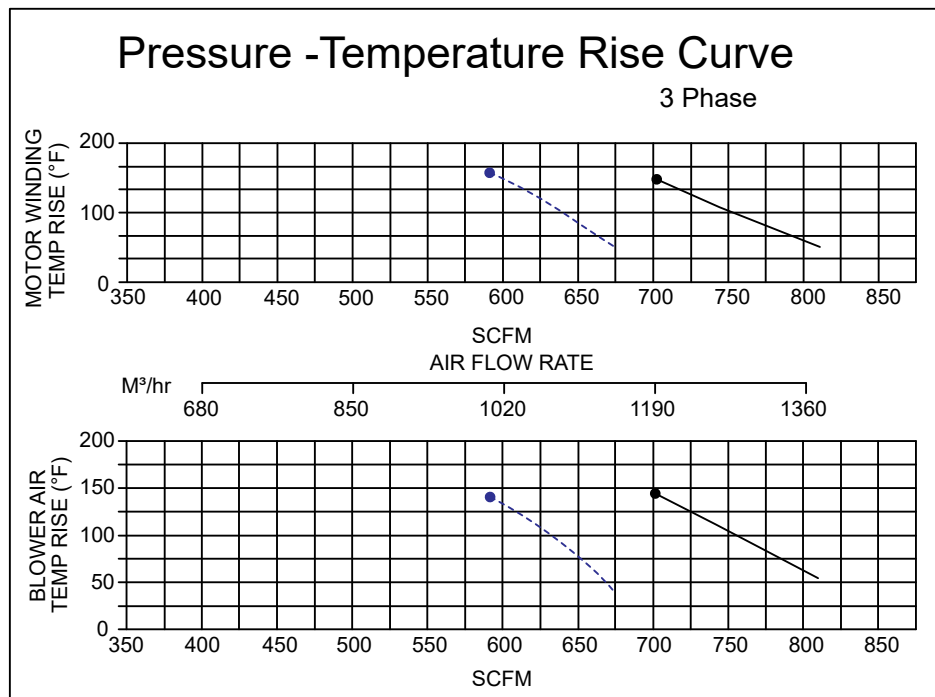
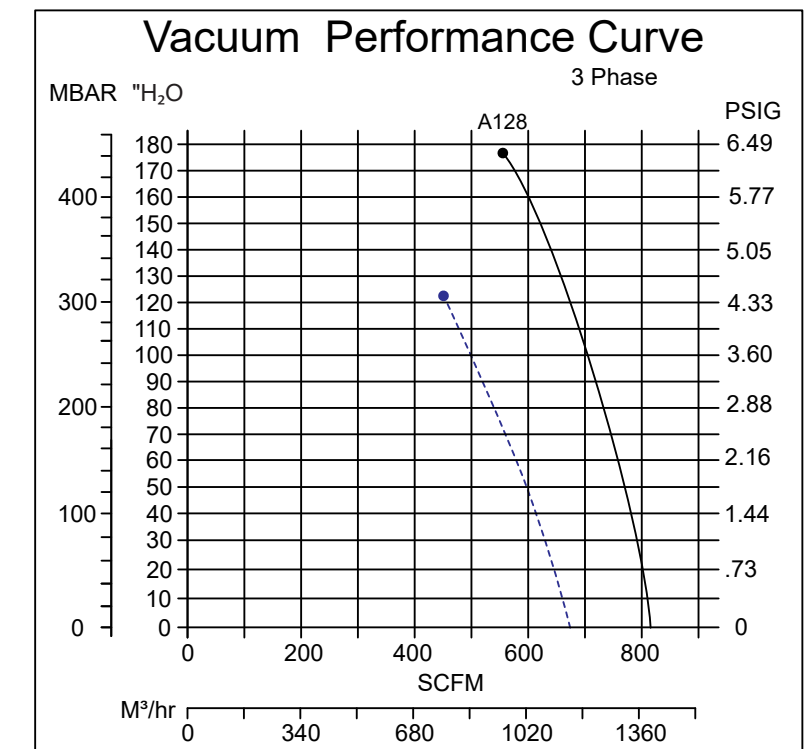
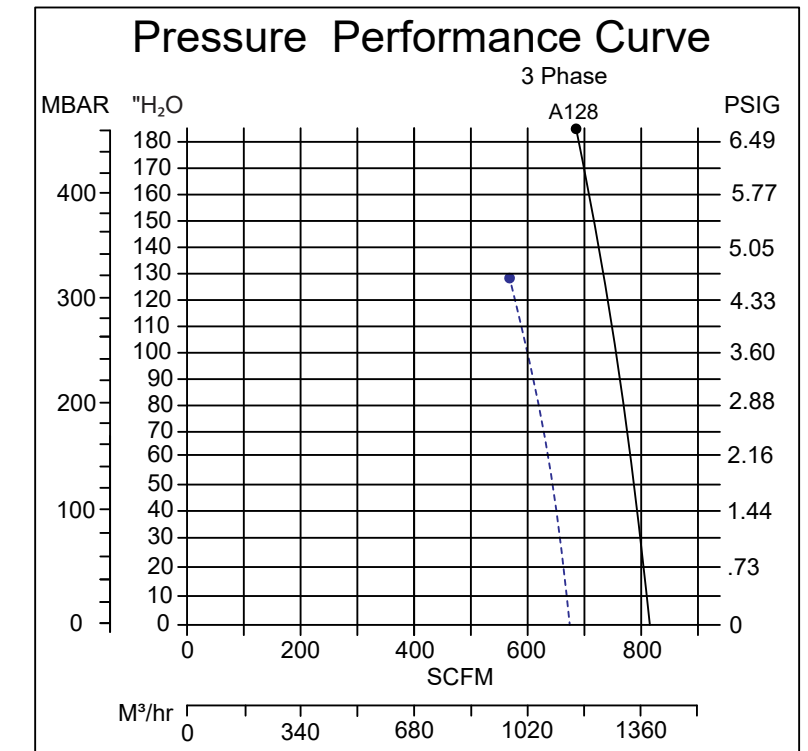
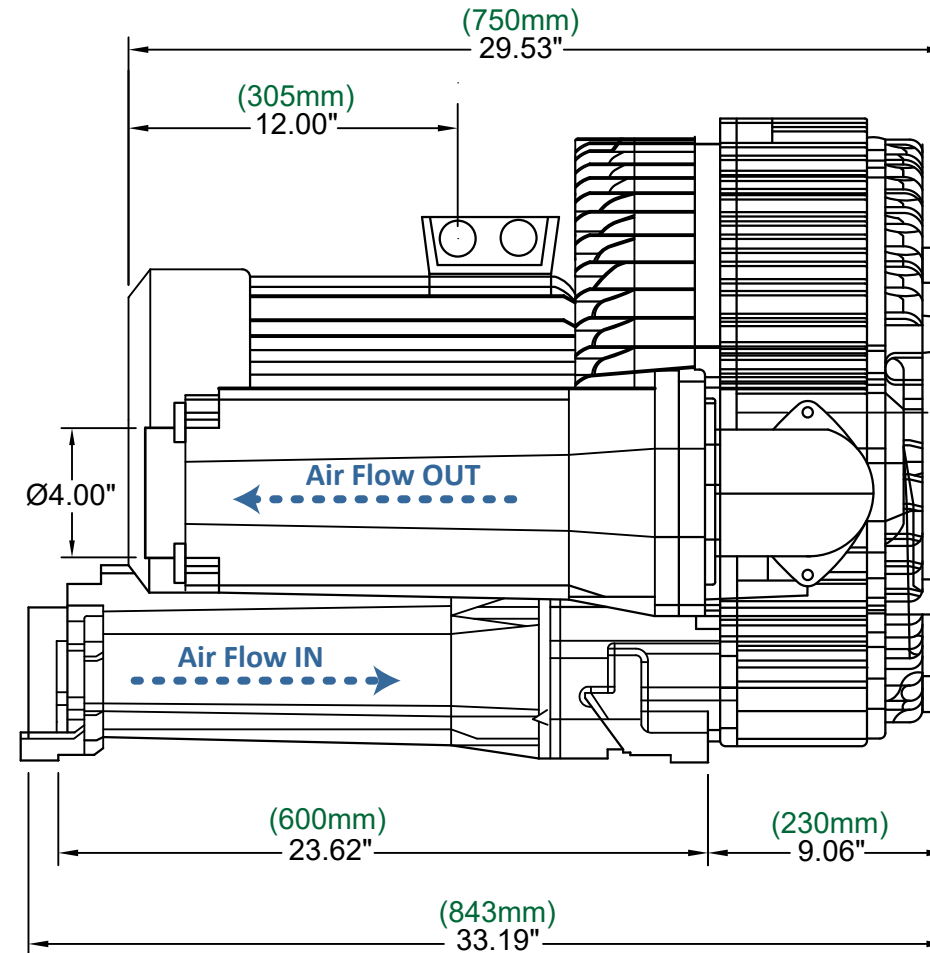
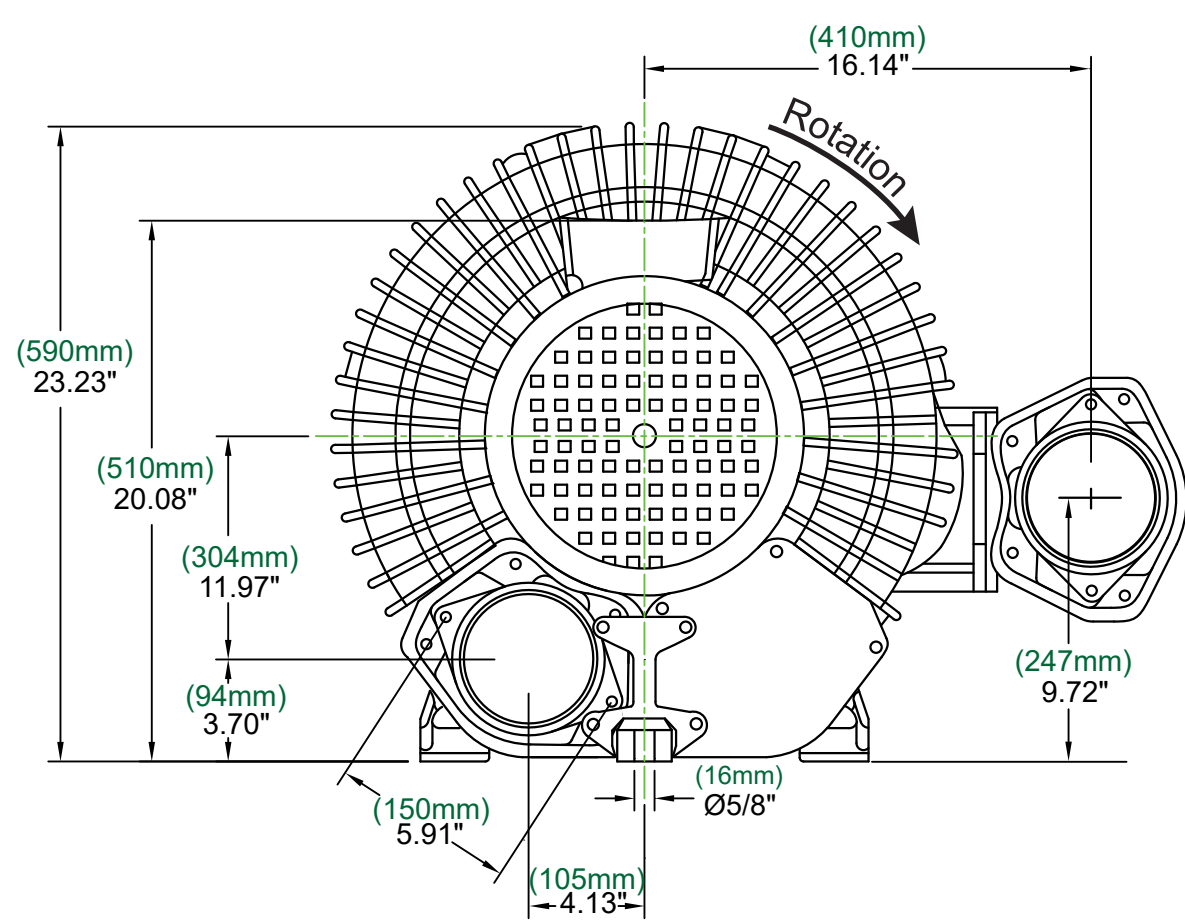

Key

- 60Hz
- - - 50Hz

Standard Conditions
 -Sea Level (14.69 PSI)
 -60°F (15°C)
 -0% Relative Humidity

Disclaimer

Ownership of this document and all accompanying information and data including but not limited to all applicable copyrights, trade secrets, patents and other intellectual property remain the property of Atlantic Blowers and are not to be copied, duplicated or reproduced, nor transmitted or disclosed to a third party without express written permission from Atlantic Blowers. Atlantic Blowers makes no representation or warranties, express or implied, with respect to the reuse of the data provided herewith, regardless of its format or the means of its transmission. The user accepts the data "as is", and assumes all risks associated with its use.