

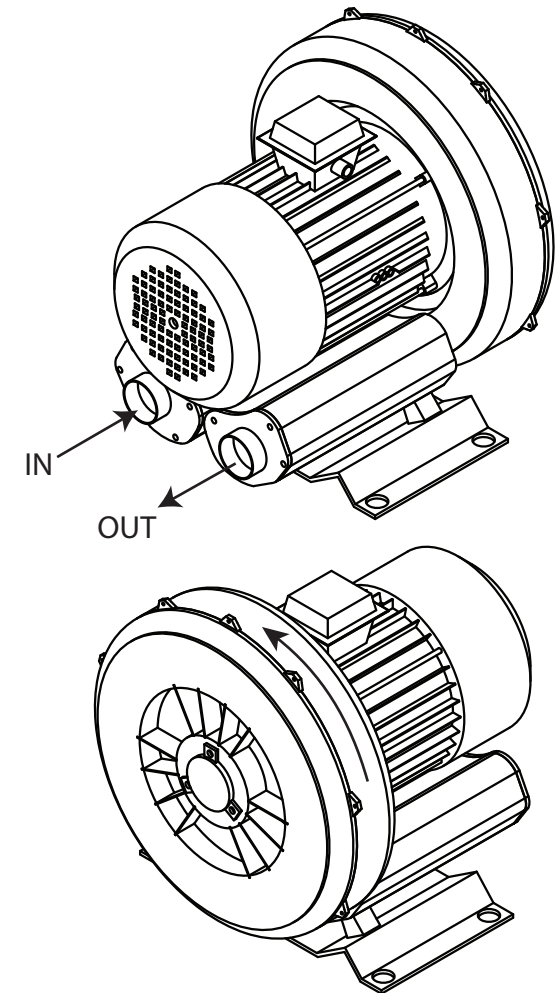

Phase	Model Number	Curve Number	Frequency (Hz)	KW	HP	Max Flow (SCFM)	Max Pressure ("H ₂ O)	Maximum Vacuum	Sound Level (db)	Inlet Diameter	Voltage	Current (A)	Weight (lbs)
1	AB-101	A4	60Hz	0.40	0.50	64	60	52	61	1.25"	110-120/220-240	7.8Δ/3.9Y	25
			50Hz	0.33	0.41	53	42	36	58		100-120/200-240	6.4Δ/3.2Y	

**Sound db measured at 3ft.

MODEL NO. : AB-101 SINGLE STAGE

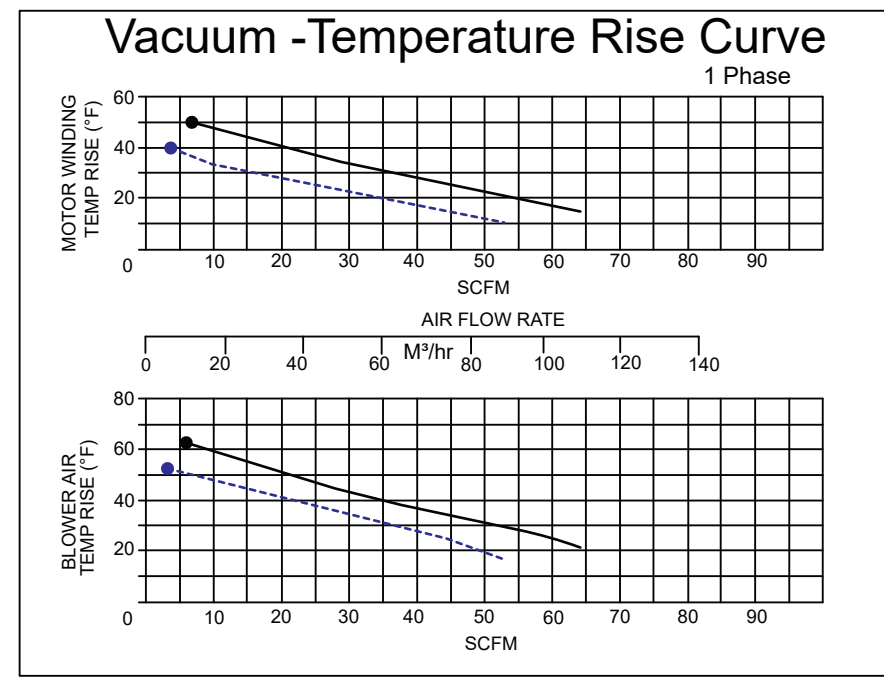
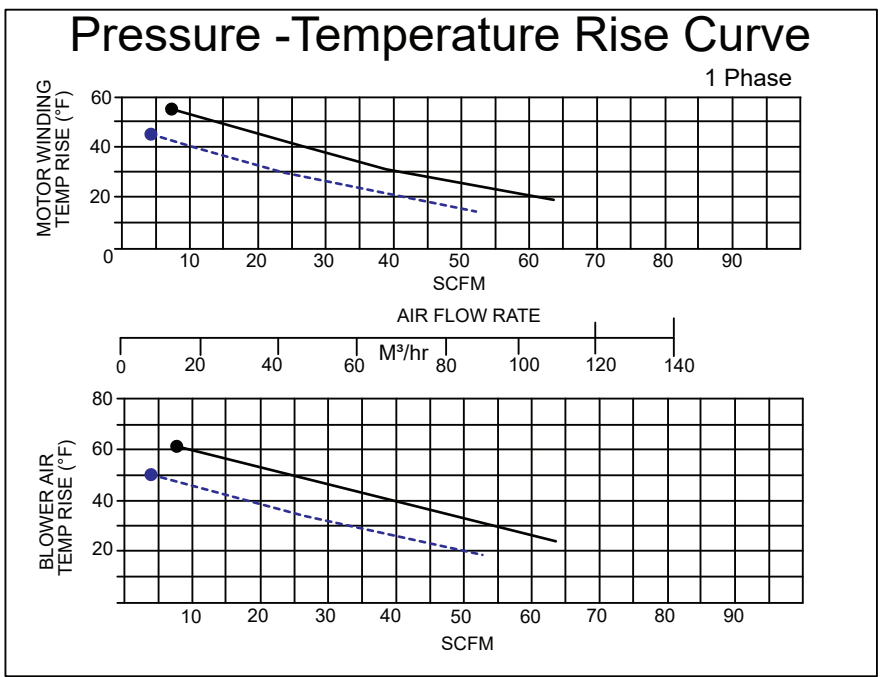
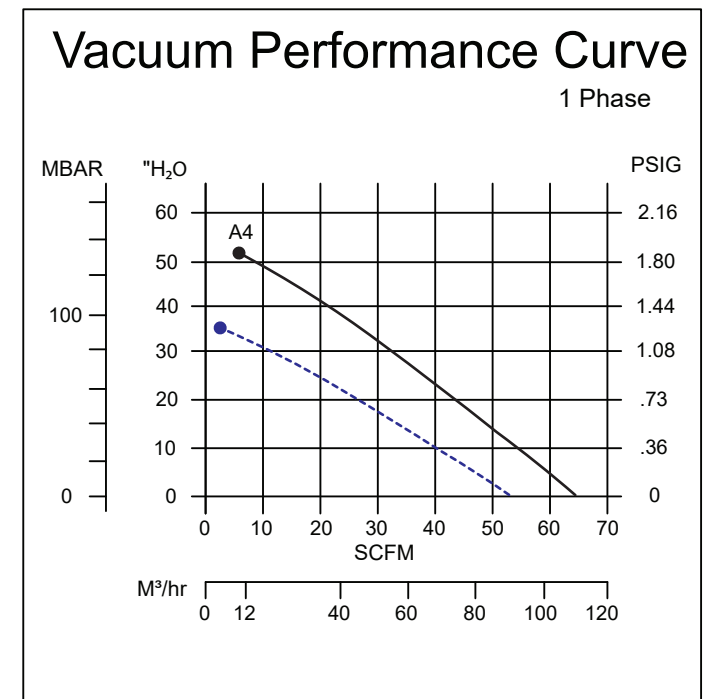
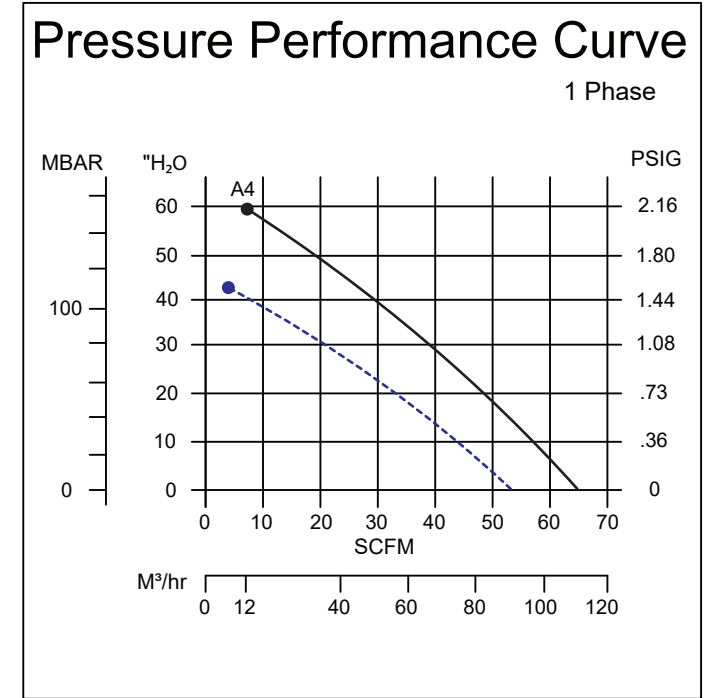
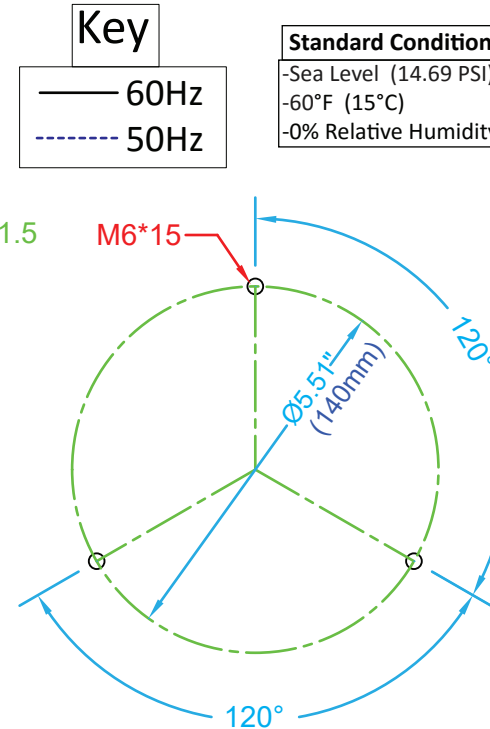
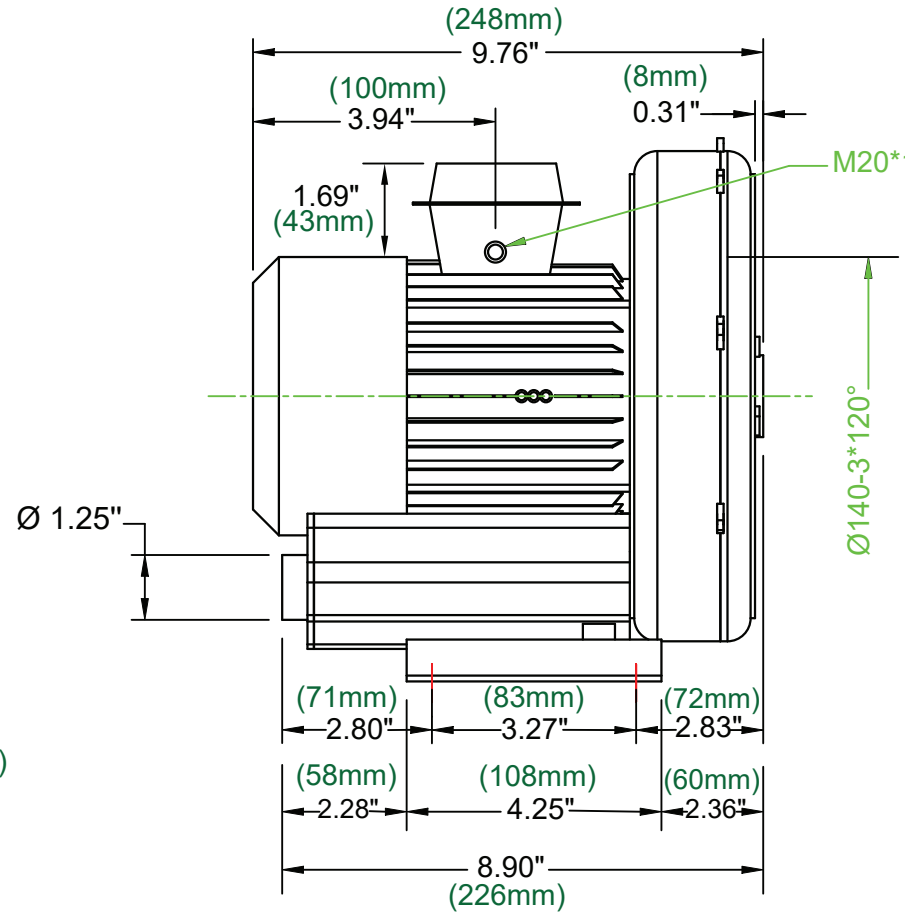
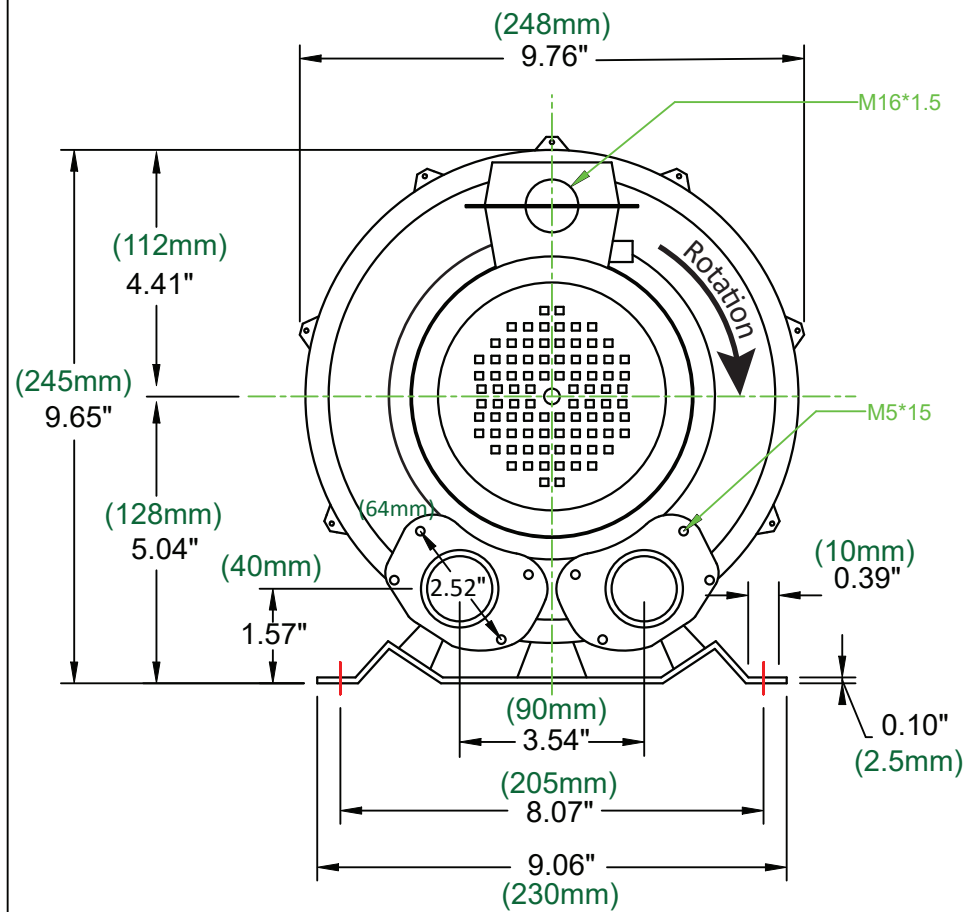

Disclaimer
 Ownership of this document and all accompanying information and data including but not limited to all applicable copyrights, trade secrets, patents and other intellectual property remain the property of Atlantic Blowers and are not to be copied, duplicated or reproduced, nor transmitted or disclosed to a third party without express written permission from Atlantic Blowers. Atlantic Blowers makes no representation or warranties, express or implied, with respect to the reuse of the data provided herewith, regardless of its format or the means of its transmission. The user accepts the data "as is", and assumes all risks associated with its use.