



### Description & Features

EH pumps are designed in accordance with ISO 2858 standard while the performance even better than ISO 2858. Pumps have superior hydraulic design, by which significantly higher efficiencies are achieved for less power consumption. The flow rates are 1.6 times and the head are 1.25 times of their correspondent sizes in ISO 2858 standard.

Pump performance can be changed by impeller trimming. There are 4 sizes of shafts and 4 sizes of bearing housing among the whole series, and many of the parts such as shaft, shaft sleeve, shaft seal and impeller nut of one pump are interchangeable with other pumps of the same bearing housing.

Back pull-out design and driven by motor or other driving device through flexible coupling, very easy and convenient to install and maintain.

### Model Instruction

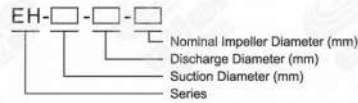

### Applications

- Water supply and drainage
- HVAC and Cooling Tower
- Fire Protection and Fire Fighting
- Marine-Ballasting & Bilge
- Booster and Pressurization Set
- Irrigation and agriculture
- Water supply and drainage

### Operating Data

**Flowrate:** Max. 1200 m<sup>3</sup>/h  
**Head:** Max. 160m  
**Discharge Diameter(mm):** 32~200  
**Working Pressure(Mpa):** 1.6~2.4  
**Temperature:** -15°C~80°C ( Normal Material )  
 80°C~145°C ( Special Material )  
**Speed(r/min):** 1450 / 2900 (50Hz),  
 1750 / 3500 (60Hz)

### Material

Pump Part	Material
Casing	Cast Iron Ductile Iron
Impeller	Cast Iron
	Brass
	Bronze
	Stainless Steel
Shaft	Carbon Steel
	Stainless Steel

### Structure & List of Parts

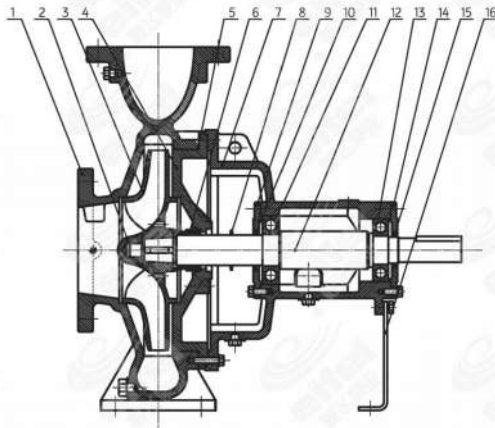

No.	Part Name
1	Casing
2	Impeller Nut
3	Impeller
4	Casing Cover
5	O-ring
6	Mechanical Seal
7	Bearing Housing
8	Slinger
9	Bearing Cover (Impeller end)
10	Oil Seal (Impeller end)
11	Bearing (Impeller end)
12	Shaft
13	Bearing (Driving end)
14	Bearing Cover (Driving end)
15	Oil Seal (Driving end)
16	Support Foot

### EH Series Installation Dimensions

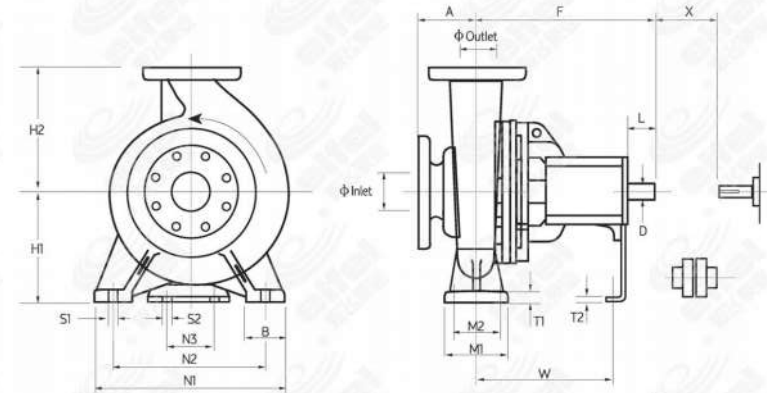

Model		Imp Dia	Shaft No.	Pump Dimensions				Mounting Dimensions				Bolt Holes		Shaft End		GAP*	Weight kg					
Inlet	Outlet			A	F	H1	H2	B	M1	M2	N1	N2	N3	T1	T2			W	S1	S2	D	L
50	32	160	1	80	385	132	160	50	100	70	240	190	110	12	6	285	M12	M12	24	50	4	43
50	32	200	1	80	385	160	180	50	100	70	240	190	110	13	6	285	M12	M12	24	50	4	49
65	50	160	1	80	385	132	160	50	100	70	240	190	110	12	6	285	M12	M12	24	50	4	44
65	40	200	1	100	385	160	180	50	100	70	265	212	110	13	6	285	M12	M12	24	50	4	51
65	40	250	2	100	500	180	225	65	125	95	320	250	110	14	6	370	M12	M12	32	80	4	71
65	40	315	2	125	500	200	250	65	125	95	345	280	110	16	6	370	M12	M12	32	80	4	90
80	65	160	1	100	385	160	180	50	100	70	265	212	110	13	6	285	M12	M12	24	50	4	49
80	50	200	1	100	385	160	200	50	100	70	265	212	110	13	6	285	M12	M12	24	50	4	53
80	50	250	2	125	500	180	225	65	125	95	320	250	110	15	6	370	M12	M12	32	80	4	76
80	50	315	2	125	500	225	280	65	125	95	345	280	110	16	6	370	M12	M12	32	80	4	94
100	80	160	2	100	500	160	200	65	125	95	280	212	110	14	6	370	M12	M12	32	80	4	68
100	65	200	2	100	500	180	225	65	125	95	320	250	110	15	6	370	M12	M12	32	80	6	72
100	65	250	2	125	500	200	250	80	160	120	360	280	110	16	6	370	M16	M12	32	80	6	84
100	65	315	3	125	530	225	280	80	160	120	400	315	110	18	8	370	M16	M12	42	110	6	122
125	80	200	2	125	500	180	250	65	125	95	345	280	110	16	6	370	M12	M12	32	80	6	81
125	80	250	2	125	500	225	280	80	160	120	400	315	110	18	8	370	M16	M12	32	80	6	95
125	80	315	3	125	530	250	315	80	160	120	400	315	110	20	8	370	M16	M12	42	110	6	130
125	80	400	3	125	530	280	355	80	160	120	435	355	110	20	8	370	M16	M12	42	110	6	163
125	100	200	2	125	500	200	280	80	160	120	360	280	110	17	6	370	M16	M12	32	80	6	87
125	100	250	3	140	530	225	280	80	160	120	400	315	110	18	8	370	M16	M12	42	110	6	122
125	100	315	3	140	530	250	315	80	160	120	400	315	110	19	8	370	M16	M12	42	110	6	138
125	100	400	3	140	530	280	355	100	200	150	500	400	110	20	8	370	M20	M12	42	110	6	175
125	100	500	4	160	670	355	450	100	210	150	540	450	140	25	10	500	M20	M16	48	110	6	378
150	125	250	3	140	530	250	355	80	160	120	400	315	110	19	8	370	M16	M12	42	110	6	135
150	125	315	3	140	530	280	355	100	200	150	500	400	110	20	8	370	M20	M12	42	110	6	166
150	125	400	3	140	530	315	400	100	200	150	500	400	110	21	8	370	M20	M12	42	110	6	193
150	125	500	4	160	670	355	450	100	210	150	540	450	140	25	10	500	M20	M16	48	110	6	402
200	150	315	4	160	670	315	400	100	210	150	540	450	140	20	10	500	M20	M16	48	110	8	274
200	150	400	4	160	670	315	450	100	210	150	540	450	140	25	10	500	M20	M16	48	110	8	339
200	150	500	4	160	670	400	500	100	210	150	540	450	140	25	10	500	M20	M16	48	110	8	426
250	200	315	4	180	670	315	450	100	210	150	540	450	140	25	10	500	M20	M16	48	110	8	314

EH Series-50Hz Performance

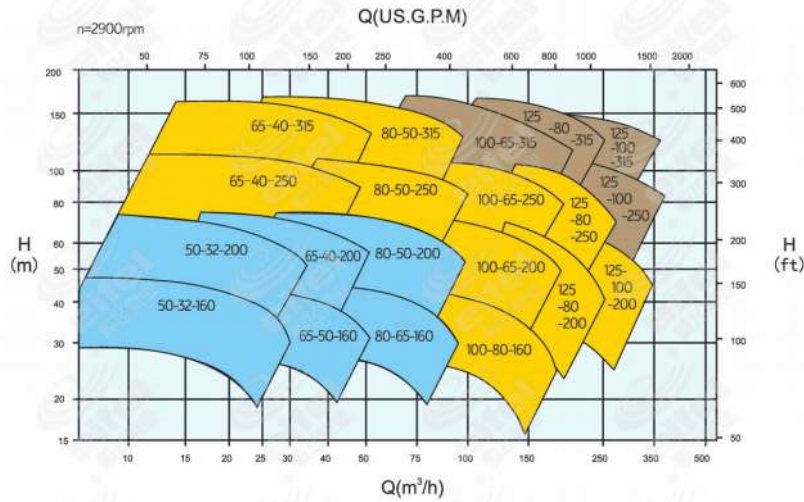

EH Series-60Hz Performance

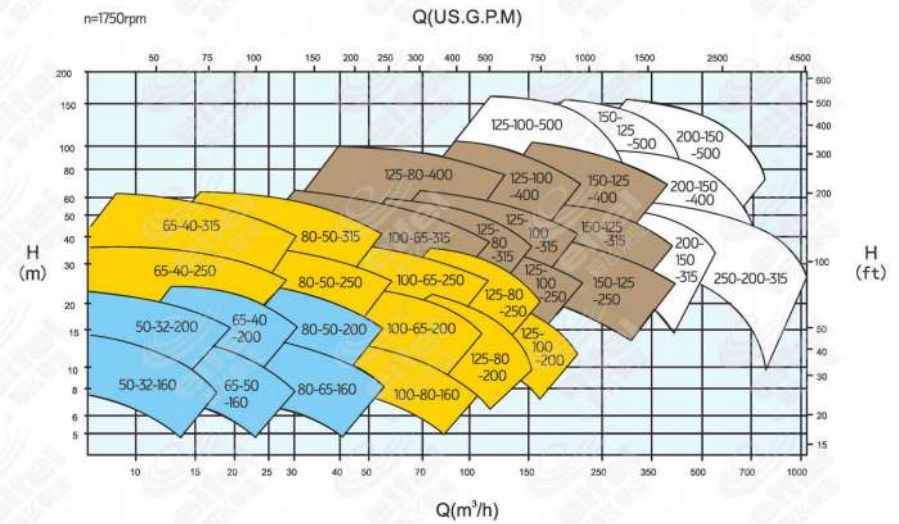
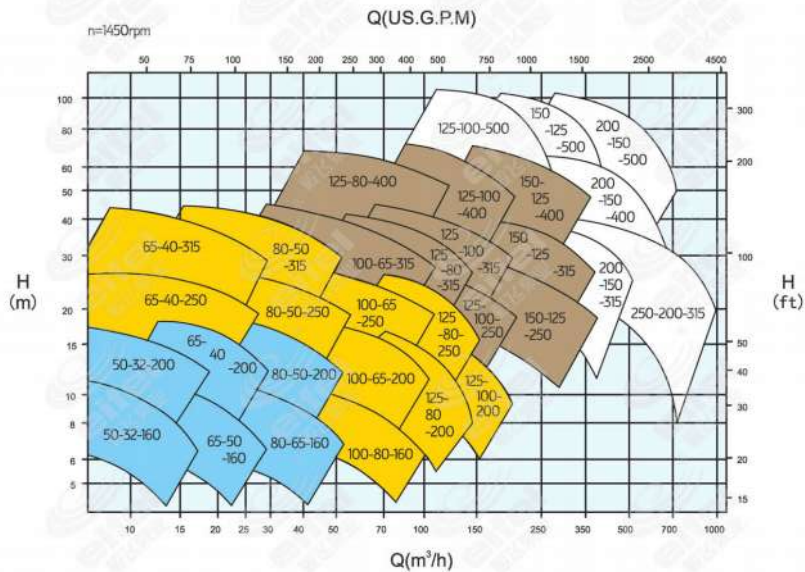
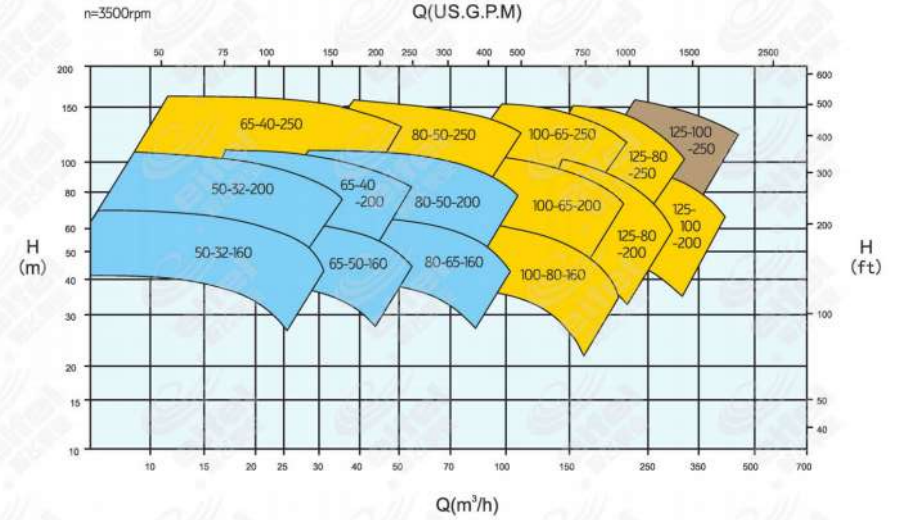

Performance to ISO9906 Grade 2 for clean cold water only

Performance to ISO9906 Grade 2 for clean cold water only