

QNO-7032R

4MP IR Bullet Camera

Network



FC | CE | EAC

Key Features

- Maximum 4MP resolution
- Color : 0.15Lux (F2.0, 1/30sec) B/W : 0Lux (IR LED On)
- 6mm fixed focal
- Maximum 30fps@4MP all resolutions (H.265/H.264)
- H.265, H.264, MJPEG codec supported, Multiple streaming
- Motion detection, Tampering, Defocus detection
- Hallway view (90°/270°), LDC support
- Micro SD/SDHC/SDXC memory slot (128GB)
- IR viewable length 30m (98.42ft)
- IP66, IK10, PoE, 12VDC

Video	
Imaging Device	1/3" CMOS
Resolution	2560 x 1440, 1920 x 1080, 1280 x 960, 1280 x 720, 800 x 600, 800 x 448, 720 x 576, 720 x 480, 640 x 480, 640 x 360, 320 x 240
Max. Framerate	H.265/H.264 : Max. 30fps at 4M all resolutions, MJPEG : Max. 15fps
Min. Illumination	Color : 0.15Lux (F2.0, 1/30sec) B/W : 0Lux (IR LED On)
Video Out	CVBS : 1.0 Vpp/75Ω composite, 720x480(N), 720x576(P) for installation
Lens	
Focal Length (Zoom Ratio)	6mm fixed focal
Max. Aperture Ratio	F2.0
Angular Field of View	H : 49.0, V : 27.6, D : 55.6
Focus Control	Fixed
Operational	
Camera Title	Displayed up to 85 characters
Day & Night	Auto(ICR)
Backlight Compensation	BLC, WDR, SDDR
Wide Dynamic Range	120dB
Digital Noise Reduction	SSNR
Motion Detection	4ea, polygonal zones
Privacy Masking	6ea, rectangular zones
Gain Control	Low / Middle / High
White Balance	ATW / AWC / Manual / Indoor / Outdoor
LDC	Support
Electronic Shutter Speed	Minimum/Maximum/Anti flicker (1/5~1/12,000sec)
Video Rotation	Flip, Mirror, Hallway view(90/270)
Analytics	Defocus detection, Directional detection, Motion detection, Enter/Exit, Tampering, Virtual line
Alarm I/O	Input 1ea / Output 1ea
Alarm Triggers	Analytics, Network disconnect, Alarm input
Alarm Events	File upload via FTP and e-mail, Notification via e-mail, SD/SDHC/SDXC or NAS recording at event triggers, Alarm output, Handover
Audio In	Selectable(mic in/line in) Supply voltage: 2.5VDC(4mA), Input impedance: 2K Ohm
IR Viewable Length	30m (98.42ft)
Network	
Ethernet	RJ-45 (10/100BASE-T)
Video Compression	H.265/H.264 : Main/High, MJPEG

Audio Compression	G.711 u-law / G.726 Selectable G.726(ADPCM) 8KHz, G.711 8KHz, G.726 16Kbps, 24Kbps, 32Kbps, 40Kbps
Smart Codec	Manual (5ea area), WiseStream II
Bitrate Control	H.264/H.265 : CBR or VBR MJPEG : VBR
Streaming	Unicast (6 users) / Multicast Multiple streaming (Up to 3 profiles)
Protocol	IPv4, IPv6, TCP/IP, UDP/IP, RTP(UDP), RTP(TCP), RTCP, RTSP, NTP, HTTP, HTTPS, SSL/TLS, DHCP, PPPoE, FTP, SMTP, ICMP, IGMP, SNMPv1/v2c/v3(MIB-2), ARP, DNS, DDNS, QoS, PIM-SM, UPnP, Bonjour, LLDP
Security	HTTPS(SSL) Login Authentication Digest Login Authentication IP Address Filtering User access Log 802.1X Authentication
Application Programming Interface	ONVIF Profile S/G/T, SUNAPI (HTTP API)
General	
Webpage Language	English, Korean, Chinese, French, Italian, Spanish, German, Japanese, Russian, Portuguese, Czech, Polish, Turkish, Dutch, Hungarian, Greek
Edge Storage	Micro SD/SDHC/SDXC 1slot 128GB
Memory	512MB RAM, 256MB Flash
Environmental & Electrical	
Operating Temperature / Humidity	-40C~+55C (-40F~+131F) / Less than 95% RH * Start up should be done at -30C or above
Storage Temperature / Humidity	-40C~+60C (-40F~+140F) / Less than 95% RH
Certification	IP66, IK10
Input Voltage	PoE(IEEE802.3af, Class3), 12VDC
Power Consumption	PoE: Max 10.7W, typical 8W 12VDC: Max 9.1W, typical 6.8W
Mechanical	
Color / Material	Dark grey / Aluminum
Product Dimensions / Weight	Ø70.0 x 246.0mm (Ø2.76 x 9.69"), 700g (1.543 lb)
Compatible Conduit hole / Gangbox	Single, Double, 4"Octagon
DORI	
Detect (25PPM/ 8PPF)	112.3m(368.60ft)
Observe (63PPM/ 19PPF)	44.9m(147.44ft)
Recognize (125PPM/ 38PPF)	22.5m(73.72ft)
Identify (250PPM/ 76PPF)	11.2m(36.86ft)

- The latest product information / specification can be found at hanwha-security.com
- Design and specifications are subject to change without notice.
- Wisenet is the proprietary brand of Hanwha Techwin, formerly known as Samsung Techwin.

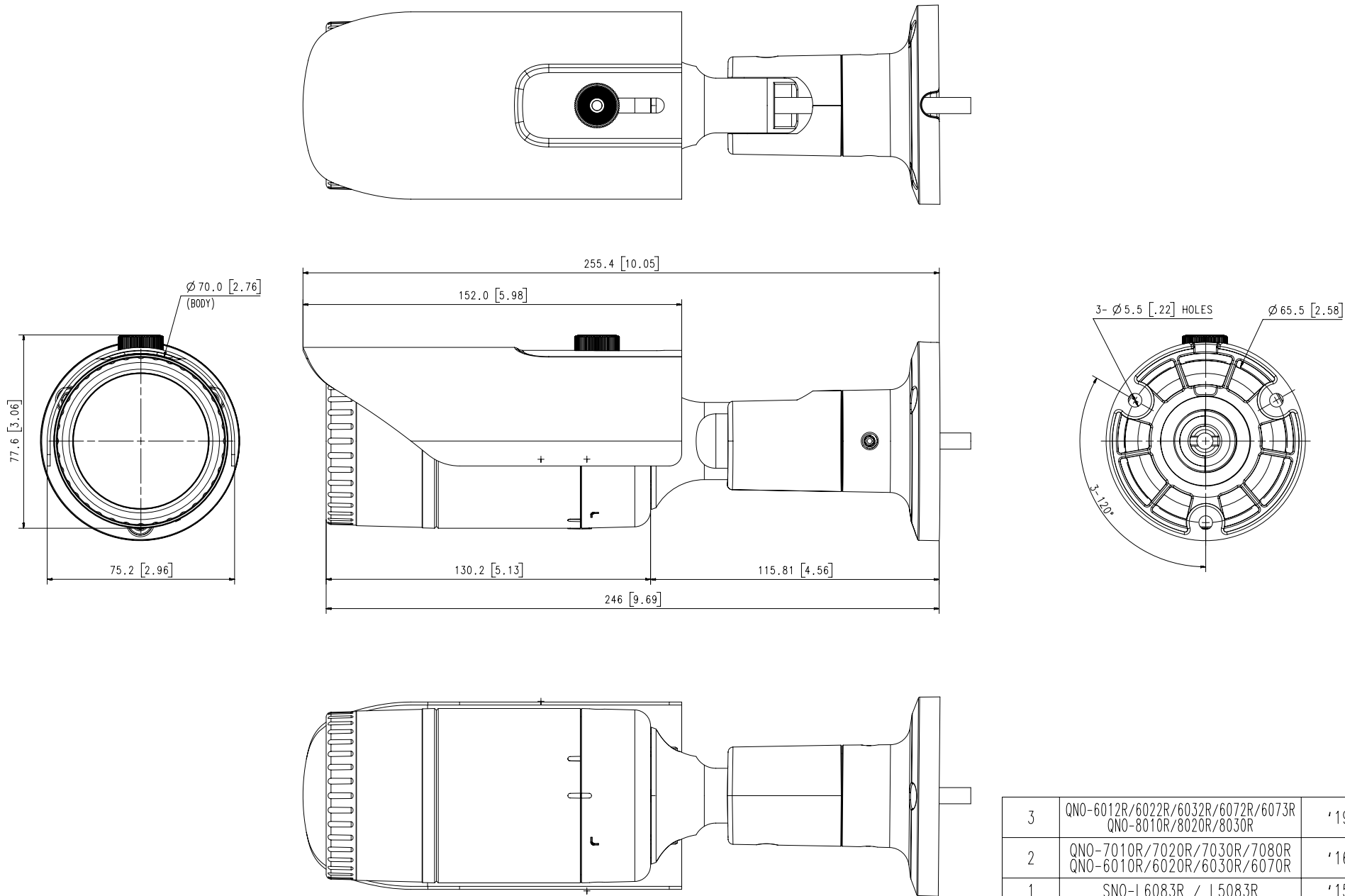

3	QNO-6012R/6022R/6032R/6072R/6073R QNO-8010R/8020R/8030R	'19.04.18
2	QNO-7010R/7020R/7030R/7080R QNO-6010R/6020R/6030R/6070R	'16.05.10
1	SNO-L6083R / L5083R	'15.02.26
No.	MODEL NAME	DATE
Unit:mm[inch] SCALE:1/1		Hanwha Techwin

© Hanwha Techwin Co.,Ltd. All rights reserved.