

# SERVICE & OPERATING MANUAL

## Original Instructions



### Model PB 1/4 Type 3

### Air-Operated Double Diaphragm Pump



See pages 2, 13 and  
for ATEX ratings.



## Table of Contents

Engineering Data and Temperature Limitations .....	1
Performance Curve .....	1
Explanation of Pump Nomenclature .....	2
Dimensions .....	3
Metric Dimensions .....	4
Principle of Pump Operation .....	5
Check Valve Servicing .....	5
Diaphragm Servicing .....	5
Troubleshooting .....	6
Warranty .....	6
Material Codes .....	7
Installation Guide .....	7
Composite Repair Parts Drawing .....	8
Available Service and Conversion Kits .....	8
Composite Repair Parts List .....	9
Grounding the Pump .....	9
Solenoid Shifted Option Drawing .....	10
Solenoid Shifted Air Valve Parts List .....	10
Solenoid Shifted Options .....	11
Solenoid Connector Drawing .....	11
CE Declaration of Conformity - Machinery .....	12
CE Declaration of Conformity - ATEX .....	13

# Safety Information

## IMPORTANT



Read the safety warnings and instructions in this manual before pump installation and start-up. Failure to comply with the recommendations stated in this manual could damage the pump and void factory warranty.



When the pump is used for materials that tend to settle out or solidify, the pump should be flushed after each use to prevent damage. In freezing temperatures the pump should be completely drained between uses.

## CAUTION



Before pump operation, inspect all fasteners for loosening caused by gasket creep. Retighten loose fasteners to prevent leakage. Follow recommended torques stated in this manual.



Nonmetallic pumps and plastic components are not UV stabilized. Ultraviolet radiation can damage these parts and negatively affect material properties. Do not expose to UV light for extended periods of time.



### WARNING

The use of non-OEM replacement parts will void (or negate) agency certifications, including CE, ATEX, CSA, 3A and EC1935 compliance (Food Contact Materials). Warren Rupp, Inc. cannot ensure nor warrant non-OEM parts to meet the stringent requirements of the certifying agencies.

## WARNING



When used for toxic or aggressive fluids, the pump should always be flushed clean prior to disassembly.



Before maintenance or repair, shut off the compressed air line, bleed the pressure, and disconnect the air line from the pump. Be certain that approved eye protection and protective clothing are worn at all times. Failure to follow these recommendations may result in serious injury or death.



Airborne particles and loud noise hazards. Wear eye and ear protection.



In the event of diaphragm rupture, pumped material may enter the air end of the pump, and be discharged into the atmosphere. If pumping a product that is hazardous or toxic, the air exhaust must be piped to an appropriate area for safe containment.



Take action to prevent static sparking. Fire or explosion can result, especially when handling flammable liquids. The pump, piping, valves, containers and other miscellaneous equipment must be properly grounded.



This pump is pressurized internally with air pressure during operation. Make certain that all fasteners are in good condition and are reinstalled properly during reassembly.



Use safe practices when lifting

## RECYCLING

Many components of SANDPIPER® AODD pumps are made of recyclable materials. We encourage pump users to recycle worn out parts and pumps whenever possible, after any hazardous pumped fluids are thoroughly flushed.

## Grounding ATEX Pumps

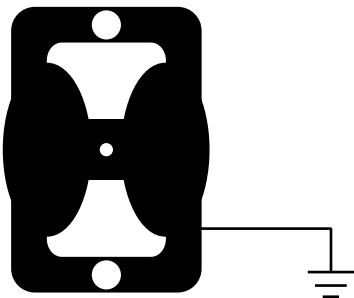

ATEX compliant pumps are suitable for use in explosive atmospheres when the equipment is properly grounded in accordance with local electrical codes. Pumps equipped with electrically conductive diaphragms are suitable for the transfer of conductive or non-conductive fluids of any explosion group. When operating pumps equipped with non-conductive diaphragms that exceed the maximum permissible projected area, as defined in EN 13461-1: 2009 section 6.7.5 table 9, the following protection methods must be applied:

- Equipment is always used to transfer electrically conductive fluids or
- Explosive environment is prevented from entering the internal portions of the pump, i.e. dry running

For further guidance on ATEX applications, please consult the factory.

Quality System  
ISO 9001 Certified

Environmental Man-  
agement System ISO  
14001 Certified



See pages 2, 13 and 14  
for ATEX ratings.



**Model PB<sup>1/4</sup>  
Type 3**

**Air-Operated  
Double Diaphragm Pump**

Engineering, Performance  
& Construction Data

<b>INTAKE/DISCHARGE PIPE SIZE</b> 1/4" NPT (internal) 1/2" NPT (external)	<b>CAPACITY</b> 0 to 4 gallons per minute (0 to 15 liters per minute)	<b>AIR VALVE</b> No-lube, no-stall design	<b>SOLIDS-HANDLING</b> Up to 1/32" (1mm)	<b>HEADS UP TO</b> 100 psi or 231 ft. of water (7 bar or 70 meters)	<b>DISPLACEMENT/STROKE</b> .01 US Gallons / .04 liters
---	---	---	---	---	---

**CAUTION!** Operating temperature limitations are as follows:

**Materials**

	Operating Temperatures	
	Maximum	Minimum
Santoprene® Injection molded thermoplastic elastomer with no fabric layer. Long mechanical flex life. Excellent abrasion resistance.	275°F 135°C	-40°F -40°C
Hytrel®: Good on acids, bases, amines and glycols at room temperatures only.	220°F 104°C	-20°F -29°C
Virgin PTFE Chemically inert, virtually impervious. Very few chemicals are known to react chemically with PTFE: molten alkali metals, turbulent liquid or gaseous fluorine and a few fluoro-chemicals such as chlorine trifluoride or oxygen difluoride which readily liberate free fluorine at elevated temperatures.	220°F 104°C	-35°F -37°C
PVDF	250°F 121°C	0°F -18°C
Polypropylene	180°F 82°C	32°F 0°C
Conductive Acetal	190°F 88°C	-20°F -29°C

For specific applications, always consult the Warren Rupp "Chemical Resistance Chart"

**CAUTION:** Nonmetallic pumps and plastic components are not UV stabilized. Ultraviolet radiation can damage these parts and negatively affect material properties. Do not expose to UV light for extended periods of time.

Maximum and Minimum Temperatures are the limits for which these materials can be operated. Temperatures coupled with pressure affect the longevity of diaphragm pump components. Maximum life should not be expected at the extreme limits of the temperature ranges.

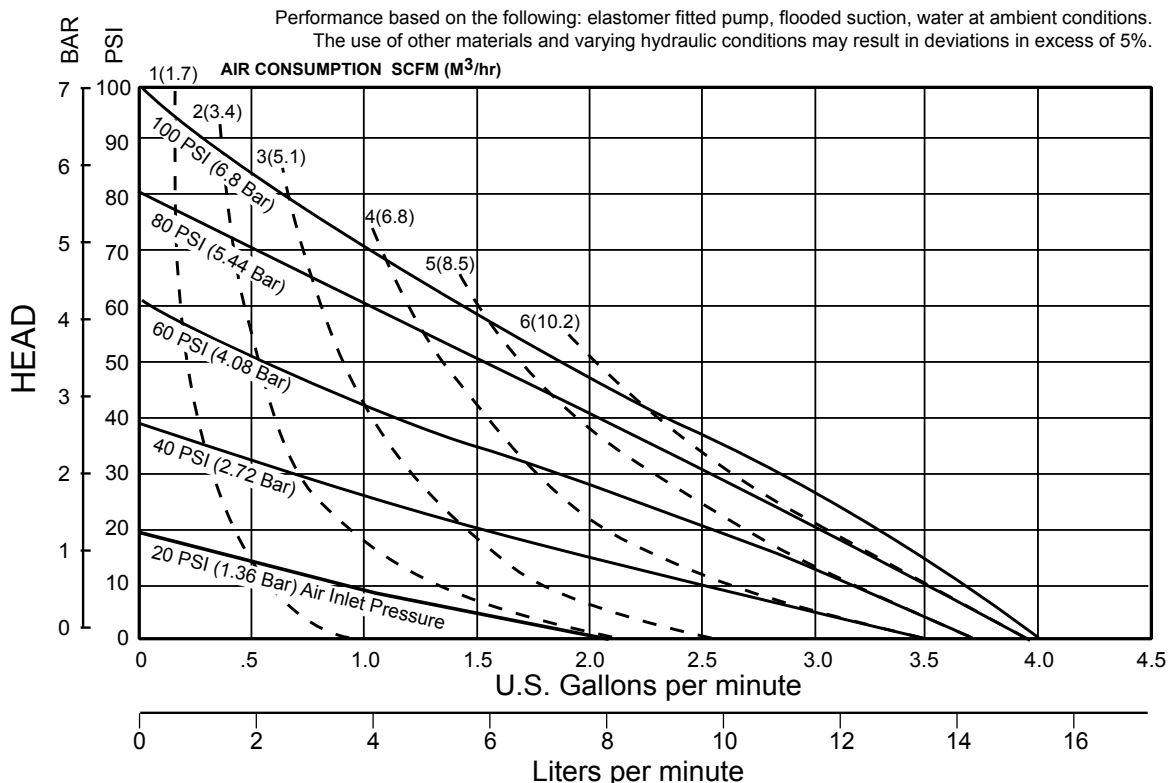

(SANDPIPER® pumps are designed to be powered only by compressed air)

# Explanation of Pump Nomenclature

Your Model #: \_\_\_\_\_  
 (fill in from pump nameplate)

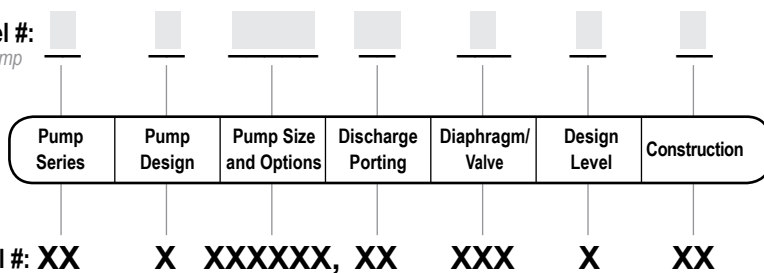

## Pump Series

P Plastic

## Pump Design

B Soiled Ball

## Pump Size and Options

1/4 1/4" NPT

P1 Intrinsically Safe ATEX Compliant Pulse Output

P0 10-30VDC Pulse Output Option

P2 110/120 or 220/240VAC Pulse Output Option

E0 Integral Solenoid 24VDC Coil

E1 Integral Solenoid 24VDC Explosion-Proof Coil

E2 Integral Solenoid 24VAC/12VDC Coil

E3 Integral Solenoid 12VDC Explosion-Proof Coil

E4 Integral Solenoid 110VAC Coil

E5 Integral Solenoid 110VAC Explosion-Proof Coil

E6 Integral Solenoid 220VAC Coil

E7 Integral Solenoid 220VAC Explosion-Proof Coil

E8 Integral Solenoid 115VAC, 50Hz Explosion-Proof Coil

E9 Integral Solenoid 230VAC, 50Hz, Explosion-Proof Coil

## Discharge Porting Position

T Top

H Horizontal Suction and Discharge

V Vertical Discharge

VV Vertical Suction and Discharge

## Diaphragm Check Valve Materials

S Santoprene

T Virgin PTFE

U Santoprene Diaphragms/PTFE Ball

## Design Level

3

## Construction

P Polypropylene Wet End and Center

K PVDF Wet End and Polypropylene Center

△ CA Conductive Acetal Wet End and Center

Your Serial #: (fill in from pump nameplate) \_\_\_\_\_

## ATEX Detail

	ATEX Detail	Construction	Muffler Options	Options
	II 1G c T5	CA	Metal	00
	II 1D c T100°C			
	I M1 c			
	I M2 c			
	II 2G c T5	CA	Integral	00
	II 2D c T100°C			
II 2G Ex ia c II T5	CA	Integral	P1	
II 2D Ex c iaD 20				
IP67 T100°C				

# Dimensions: PB $\frac{1}{4}$ Non-Metallic

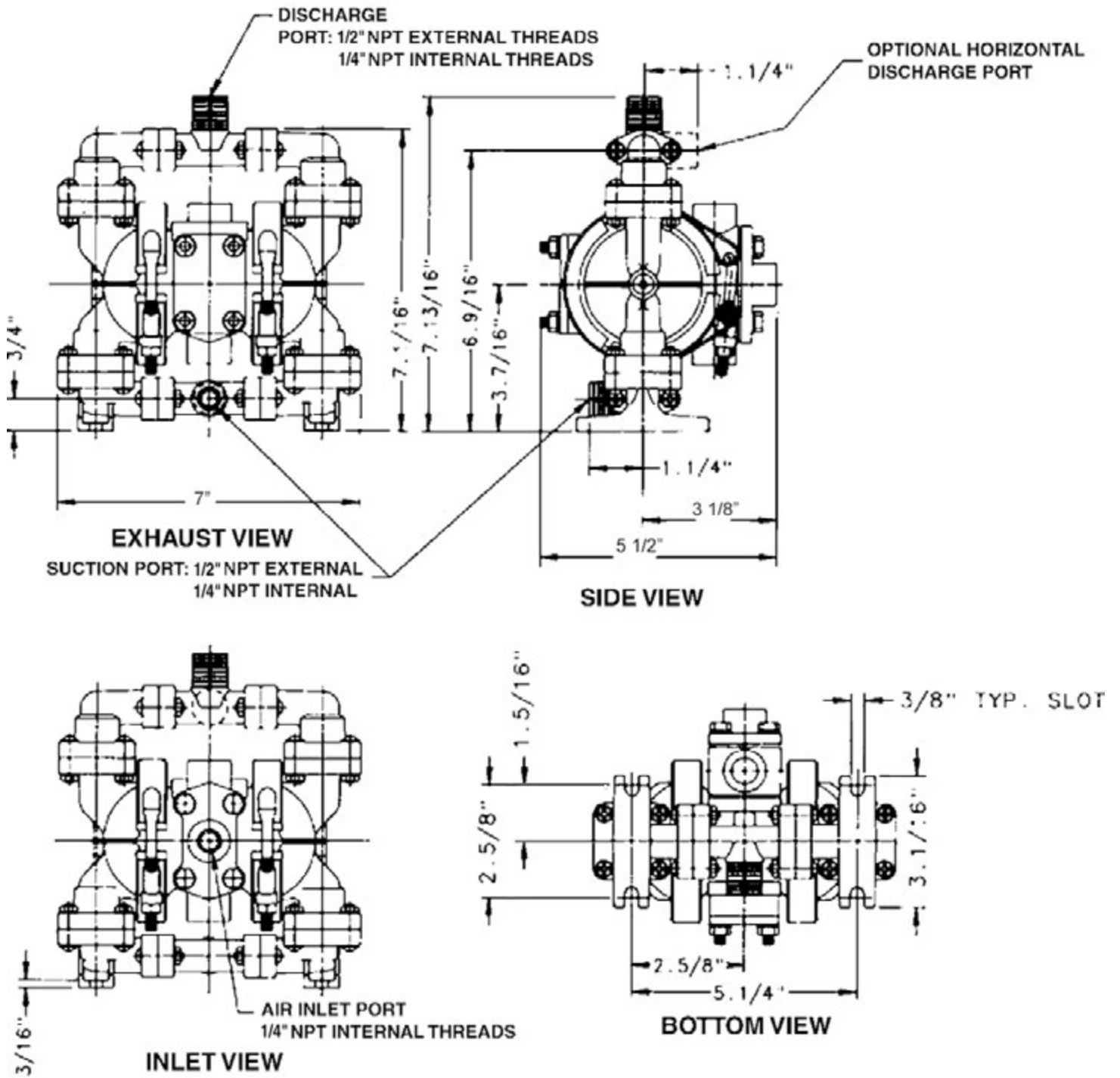

Dimension	A	B	C
Standard	7"	3 1/8"	5 1/2"
Pulse Output Kit	7"	3 1/8"	5 1/2"

# Metric Dimensions: PB<sup>1</sup>/<sub>4</sub> Non-Metallic

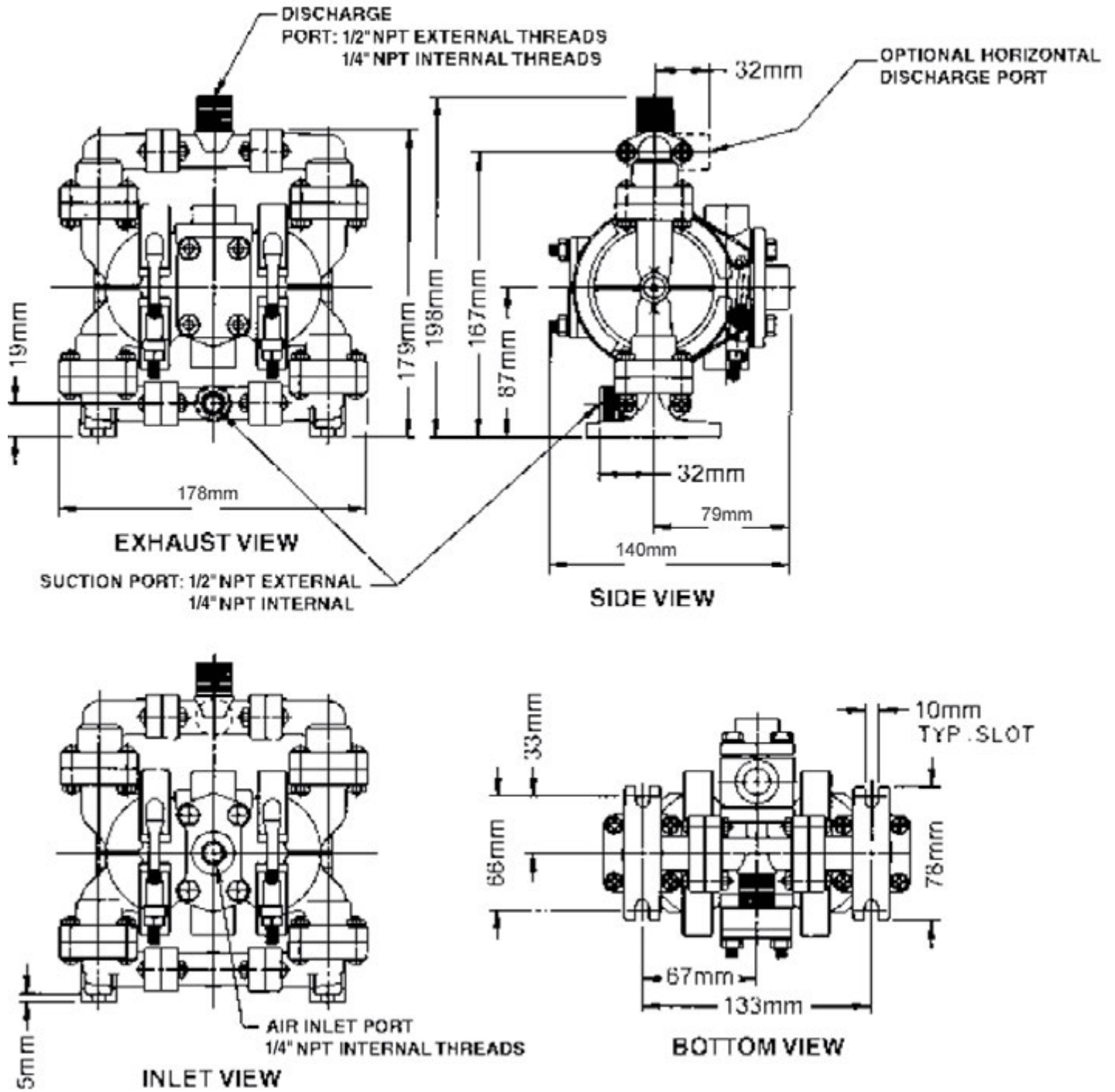

Dimension	A	B	C
Standard	178	79	140
Pulse Output Kit	178	79	140



## PRINCIPLE OF PUMP OPERATION

This ball type check valve pump is powered by compressed air and is a 1:1 ratio design. The inner side of one diaphragm chamber is alternately pressurized while simultaneously exhausting the other inner chamber. This causes the diaphragms, which are connected by a common rod secured by plates to the centres of the diaphragms, to move in a reciprocating action. (As one diaphragm performs the discharge stroke the other diaphragm is pulled to perform the suction stroke in the opposite chamber.) Air pressure is applied over the entire inner surface of the diaphragm while liquid is discharged from the opposite side of the diaphragm. The diaphragm operates in a balanced condition during the discharge stroke which allows the pump to be operated at discharge heads over 200 feet (61 meters) of water.

For maximum diaphragm life, keep the pump as close to the liquid being pumped as possible. Positive suction head in excess of 10 feet of liquid (3.048 meters) may require a back pressure regulating device to maximize diaphragm life.

Alternate pressurizing and exhausting of the diaphragm chamber is performed by an externally mounted, pilot operated, four way spool type air distribution valve. When the spool shifts to one end of the valve body, inlet pressure is applied to one diaphragm chamber and the other diaphragm chamber exhausts. When the spool shifts to the opposite end of the valve body, the pressure to the chambers is reversed. The air distribution valve spool is moved by an internal pilot valve which alternately pressurizes one end of the air distribution valve spool while exhausting the other end. The pilot valve is shifted at each end of the dia-

phragm stroke when an actuator plunger is contacted by the diaphragm plate. This actuator plunger then pushes the end of the pilot valve spool into position to activate the air distribution valve.

The chambers are connected with manifolds with a suction and discharge check valve for each chamber, maintaining flow in one direction through the pump.

## INSTALLATION AND START-UP

Locate the pump as close to the product being pumped as possible. Keep the suction line length and number of fittings to a minimum. Do not reduce the suction line diameter.

For installations of rigid piping, short sections of flexible hose should be installed between the pump and the piping. The flexible hose reduces vibration and strain to the pumping system. A surge suppressor is recommended to further reduce pulsation in flow.

## AIR SUPPLY

Air supply pressure cannot exceed 100 psi (7 bar). Connect the pump air inlet to an air supply of sufficient capacity and pressure required for desired performance. When the air supply line is solid piping, use a short length of flexible hose not less than 1/2" (13mm) in diameter between the pump and the piping to reduce strain to the piping. The weight of the air supply line, regulators and filters must be supported by some means other than the air inlet cap. Failure to provide support for the piping may result in damage to the pump. A pressure regulating valve should be installed to insure air supply pressure does not exceed recommended limits.

## AIR VALVE LUBRICATION

The air distribution valve and the pilot valve are designed to operate WITHOUT lubrication. This is the preferred mode of operation. There may be instances of personal preference or poor quality air supplies when lubrication of the compressed air supply is required. The pump air system will operate with properly lubricated compressed air supply. Proper lubrication requires the use of an air line lubricator (available from Warren Rupp) set to deliver one drop of SAE 10 non-detergent oil for every 20 SCFM (9.4 liters/sec.) of air the pump consumes at the point of operation. Consult the pump's published Performance Curve to determine this.

## AIR LINE MOISTURE

Water in the compressed air supply can create problems such as icing or freezing of the exhaust air, causing the pump to cycle erratically or stop operating. Water in the air supply can be reduced by using a point-of-use air dryer to supplement the user's air drying equipment. This device removes water from the compressed air supply and alleviates the icing or freezing problems.

## AIR INLET AND PRIMING

To start the pump, open the air valve approximately 1/2 to 3/4 turn. After the pump primes, the air valve can be opened to increase air flow as desired. If opening the valve increases cycling rate, but does not increase the rate of flow, cavitation has occurred. The valve should be closed slightly to obtain the most efficient air flow to pump flow ratio.

## BETWEEN USES

When the pump is used for materials that tend to settle out or solidify when not in motion, the pump should be flushed after each use to prevent damage. (Product remaining in the pump between uses could dry out or settle out. This could cause problems with the diaphragms and check valves at restart.) In freezing temperatures the pump must be completely drained between uses in all cases.

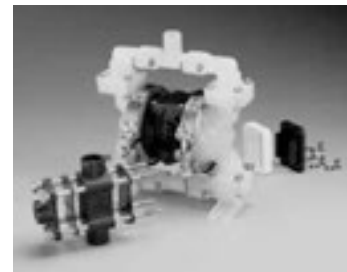

Figure 1



Figure 2

## CHECK VALVE SERVICING

Need for inspection or service is usually indicated by poor priming, unstable cycling, reduced performance or the pump's cycling but not pumping.

Remove the sixteen machine screws securing the manifold assemblies to the outer chambers. Inspect the surfaces of both check valve and seat for wear or damage that could prevent proper sealing. If pump is to prime properly, valves must seat air tight.

## DIAPHRAGM SERVICING

Remove the two V-Band clamps securing the outer chambers to the intermediate housing. Remove the diaphragm assembly (outer plate, diaphragm, inner plate) by turning the assembly counterclockwise using a 1/2" (1.27 cm) wrench on the outer plate lugs. (If a socket is used, it must be a six point socket.) The interior components consisting of the shaft seal and pilot valve assembly are now accessible for service.

Procedures for reassembling the diaphragms are the reverse of the above. Install the diaphragm with the natural bulge outward.

Install the outer diaphragm plate on the outside of the diaphragm and make certain that the large radius side of the inner plate is toward the diaphragm. Tighten the outer diaphragm plate to approximately 30 in./lbs. (3.39 Newton meters).

Torque while allowing the diaphragm to turn freely with plates. Use a wrench on the outer diaphragm plate of the

opposite side to keep rod from rotating. If the opposite chamber is assembled, the rod need not be held.

## EXTERNALLY SERVICEABLE MAIN AIR DISTRIBUTION VALVE

To service the main air distribution, first shut-off and disconnect the air supply to the pump. Remove the four long hex cap screws and hex nuts (on opposite side of pump) which fasten the main air valve body (item 1), gaskets (item 8 and 11), muffler (item 14), and caps (item 6 and 15) to the pump.

Once the main air valve body is off the pump remove the retaining rings (items 7) that hold the end caps in place. Remove the end caps (items 6) to inspect the spool and sleeve. Remove the main air spool (part of item 2) and inspect for damage or wear. Inspect the inside diameter of the main air valve (item 2) for dirt, scratches, or other contaminants. Remove and replace the sleeve if needed. When reinstalling the sleeve, apply a light coating of grease to the six o-rings (item 3) before inserting the sleeve into the main air valve body. Align the holes in the sleeve with the slots in main valve body, making sure the sleeve is centered in the bore. Clean the main air valve spool, lightly grease the o-rings, and insert into the sleeve flush to one end. Reinstall the end caps and retaining rings. The main air valve body is now ready to put back on the pump.

Assemble the air inlet cap (item 9), valve body gasket (item 8), to the main air valve body (making sure the five rectangular slots face the air inlet cap), and the intermediate gasket onto the four hex

capscrews and install onto the pump. Slide the muffler (item 14) and the exhaust cap (item 15) over the capscrews. Re-install the washers (item 10) and hex nuts (items 16) onto the four hex capscrews and torque to 30 in./lbs. (3.39 Newton meters).

## SERVICING THE PILOT VALVE

To remove the pilot valve spool (item 23) first remove the end o-ring (item 24) from one end of spool. Slide the spool out of the sleeve and inspect the five remaining o-rings (items 24) for damage or wear. If necessary, replace damaged o-rings. Inspect the inner diameter of pilot valve sleeve (item 20) for scratches, dirt, or other contaminants. Replace the sleeve if necessary. To remove the sleeve first remove the retaining ring from one end. When installing a pilot valve sleeve first lightly grease the six o-rings (items 21). Insert the sleeve into the chamfered end of bore on the intermediate bracket (item 13). Push the sleeve in until the shoulder is flush to intermediate bracket surface and install the retaining ring (item 22). To install the pilot valve spool first lightly grease the four interior o-rings and insert into the pilot valve sleeve. After inserting the spool into the sleeve install the remaining loose o-rings onto spool.

## SERVICING DIAPHRAGM ROD SEALS

To service the rod seals (item 18) first remove pilot valve, then remove the inserts on each of the intermediate brackets (item 17) by prying them out with a small flat screwdriver. After removing the inserts take the K-R rod seals out of the inserts and replace. When reinstalling the seals, make sure

the open side of the seals face into the counterbore in the inserts. To install the inserts into intermediate bracket, simply press the insert into the counterbore in each of the intermediate bracket, making sure that the closed side of insert faces out. The inserts should be flush to the surface of the intermediate bracket or slightly below the surface when fully installed.



Figure 3



Figure 4

## **TROUBLESHOOTING**

### **Possible Symptoms:**

- Pump will not cycle.
- Pump cycles, but produces no flow.
- Pump cycles, but flow rate is unsatisfactory.
- Pump cycle seems unbalanced.
- Pump cycle seems to produce excessive vibration.

**What to Check:** Excessive suction lift in system.

**Corrective Action:** For lifts exceeding 20 feet (6 meters), filling the pumping chambers with liquid will prime the pump in most cases.

**What to Check:** Excessive flooded suction in system.

**Corrective Action:** For flooded conditions exceeding 10 feet (3 meters) of liquid, install a back pressure device.

**What to Check:** System head exceeds air supply pressure.

**Corrective Action:** Increase the inlet air pressure to the pump. Most diaphragm pumps are designed for 1:1 pressure ratio at zero flow.

**What to Check:** Air supply pressure or volume exceeds system head.

**Corrective Action:** Decrease inlet air pressure and volume to the pump as calculated on the published PERFORMANCE CURVE. Pump is cavitating the fluid by fast cycling.

**What to Check:** Undersized suction line.

**Corrective Action:** Meet or exceed pump connection recommendations shown on the DIMENSIONAL DRAWING.

**What to Check:** Restricted or undersized air line.

**Corrective Action:** Install a larger air line and connection. Refer to air inlet recommendations shown in your pump's SERVICE MANUAL.

**What to Check:** Check ESADS, the Externally Serviceable Air Distribution System of the pump.

**Corrective Action:** Disassemble and inspect the main air distribution valve, pilot valve and pilot valve actuators. Refer to the parts drawing and air valve section of the SERVICE MANUAL. Check for clogged discharge or closed valve before reassembly.

**What to Check:** Rigid pipe connections to pump.

**Corrective Action:** Install flexible connectors and a Warren Rupp® Tranquillizer® surge suppressor.

**What to Check:** Blocked air exhaust muffler.

**Corrective Action:** Remove muffler screen, clean or de-ice and reinstall. Refer to the Air Exhaust section of your pump SERVICE MANUAL.

**What to Check:** Pumped fluid in air exhaust muffler.

**Corrective Action:** Disassemble pump chambers. Inspect for diaphragm rupture or loose diaphragm plate assembly. Refer to the Diaphragm Replacement section of your pump SERVICE MANUAL.

**What to Check:** Suction side air leakage or air in product.

**Corrective Action:** Visually inspect all suction side gaskets and pipe connections.

**What to Check:** Obstructed check valve.

**Corrective Action:** Disassemble the wet end of the pump and manually dislodge obstruction in the check valve pocket. Refer to the Check Valve section of the pump SERVICE MANUAL for disassembly instructions.

**What to Check:** Worn or misaligned check valve or check valve seat.

**Corrective Action:** Inspect check valves and seats for wear and proper seating. Replace if necessary. Refer to Check Valve section of the pump SERVICE MANUAL for disassembly instructions.

**What to Check:** Blocked suction line.

**Corrective Action:** Remove or flush obstruction. Check and clear all suction screens and strainers.

**What to Check:** Blocked discharge line.

**Corrective Action:** Check for obstruction or closed discharge line valves.

**What to Check:** Blocked pumping chamber.

**Corrective Action:** Disassemble and inspect the wetted chambers of the pump. Remove or flush any obstructions.

**What to Check:** Entrained air or vapor lock in one or both pumping chambers.

**Corrective Action:** Purge chambers through tapped chamber vent plugs. PURGING THE CHAMBERS OF AIR CAN BE DANGEROUS! Contact the Warren Rupp Technical Services Department before performing this procedure. Any model with top-ported discharge will reduce or eliminate problems with entrained air.

If your pump continues to perform below your expectations, contact your local Warren Rupp Distributor or factory Technical Services Group for a service evaluation.

## **WARRANTY**

This pump is warranted for a period of five years against defective material and workmanship. Failure to comply with the recommendations stated in this manual voids all factory warranty.



# Material Codes

## The Last 3 Digits of Part Number

000	Assembly, sub-assembly; and some purchased items
010	Cast Iron
012	Powered Metal
015	Ductile Iron
020	Ferritic Malleable Iron
025	Music Wire
080	Carbon Steel, AISI B-1112
100	Alloy 20
110	Alloy Type 316 Stainless Steel
111	Alloy Type 316 Stainless Steel (Electro Polished)
112	Alloy C
113	Alloy Type 316 Stainless Steel (Hand Polished)
114	303 Stainless Steel
115	302/304 Stainless Steel
117	440-C Stainless Steel (Martensitic)
120	416 Stainless Steel (Wrought Martensitic)
123	410 Stainless Steel (Wrought Martensitic)
148	Hardcoat Anodized Aluminium
149	2024-T4 Aluminium
150	6061-T6 Aluminium
151	6063-T6 Aluminium
152	2024-T4 Aluminium (2023-T351)
154	Almag 35 Aluminium
155	356-T6 Aluminium
156	356-T6 Aluminium
157	Die Cast Aluminium Alloy #380
158	Aluminium Alloy SR-319
159	Anodized Aluminium
162	Brass, Yellow, Screw Machine Stock
165	Cast Bronze, 85-5-5-5
166	Bronze, SAE 660
170	Bronze, Bearing Type, Oil Impregnated
175	Die Cast Zinc
180	Copper Alloy
305	Carbon Steel, Gray Epoxy Coated
306	Carbon Steel, Black PTFE Coated
307	Aluminium, Gray Epoxy Coated
308	Stainless Steel, Black PTFE Coated
309	Aluminium, Black PTFE Coated
310	PVDF Coated
330	Zinc Plated Steel
331	Chrome Plated Steel
332	Aluminium, Electroless Nickel Plated

333	Carbon Steel, Electroless Nickel Plated
335	Galvanized Steel
336	Zinc Plated Yellow Brass
337	Silver Plated Steel
340	Nickel Plated
342	Filled Nylon
353	Geolast; Color: Black
354	Injection Molding #203-40 Santoprene- Duro 40D +/-5; Color: RED
355	Thermal Plastic
356	Hytrek
357	Injection Molding Polyurethane (Urethane Rubber) (Compression Mold)
358	Urethane Rubber
359	Nitrile Rubber. Color coded: RED
360	Nitrile
361	Nitrile
363	FKM (Fluorocarbon). Color coded: YELLOW
364	EPDM Rubber. Color coded: BLUE
365	Neoprene Rubber. Color coded: GREEN
366	Food Grade Nitrile
368	Food Grade EPDM
370	Butyl Rubber. Color coded: BROWN
371	Phlthane (Tuftane)
374	Carboxylated Nitrile
375	Fluorinated Nitrile
378	High Density Polypropylene
379	Conductive Nitrile
405	Cellulose Fibre
408	Cork and Neoprene
425	Compressed Fibre
426	Blue Gard
440	Vegetable Fibre
465	Fibre
500	Delrin 500
501	Delrin 570
502	Conductive Acetal, ESD-800
503	Conductive Acetal, Glass-Filled
505	Acrylic Resin Plastic
506	Delrin 150
520	Injection Molding PVDF Natural color
540	Nylon
541	Nylon
542	Nylon
544	Nylon Injection Molding
550	Polyethylene
551	Glass Filled Polypropylene
552	Unfilled Polypropylene

553	Unfilled Polypropylene
555	Polyvinyl Chloride
556	Black Vinyl
557	Unfilled Conductive Polypropylene
559	Glass Filled - Conductive Polypropylene
570	Rulon II
580	Ryton
590	Valox
591	Nylatron G-S
592	Nylatron NSB
600	PTFE (virgin material)
	Tetrafluorocarbon (TFE)
601	PTFE (Bronze and moly filled)
602	Filled PTFE
603	Blue Gylon
604	PTFE
607	Envelon
606	PTFE
610	PTFE Encapsulated Silicon
611	PTFE Encapsulated FKM
632	Neoprene/Hytrek
633	FKM/PTFE
634	EPDM/PTFE
635	Neoprene/PTFE
637	PTFE, FKM/PTFE
638	PTFE, Hytrek/PTFE
639	Nitrile/TFE
643	Santoprene®/EPDM
644	Santoprene®/PTFE
656	Santoprene Diaphragm and Check Balls/EPDM Seats

Delrin and Hytrek are registered trademarks of E.I. DuPont.

Gylon is a registered trademark of Garlock, Inc.

Nylatron is a registered trademark of Polymer Corp.

Santoprene is a registered trademark of Exxon Mobil Corp.

Rulon II is a registered trademark of Dixon Industries Corp.

Ryton is a registered trademark of Phillips Chemical Co.

Valox is a registered trademark of General Electric Co.

Rupplon, SANDPIPER, PortaPump, Tranquillizer and SludgeMaster are registered trademarks of Warren Rupp, Inc.



## INSTALLATION GUIDE Top Discharge Ball Valve Unit

Available from  
Warren Rupp

- ① DA05 Non-Metallic Surge Dampener
- ② 020-049-000 Filter/Regulator
- ③ Air Dryer

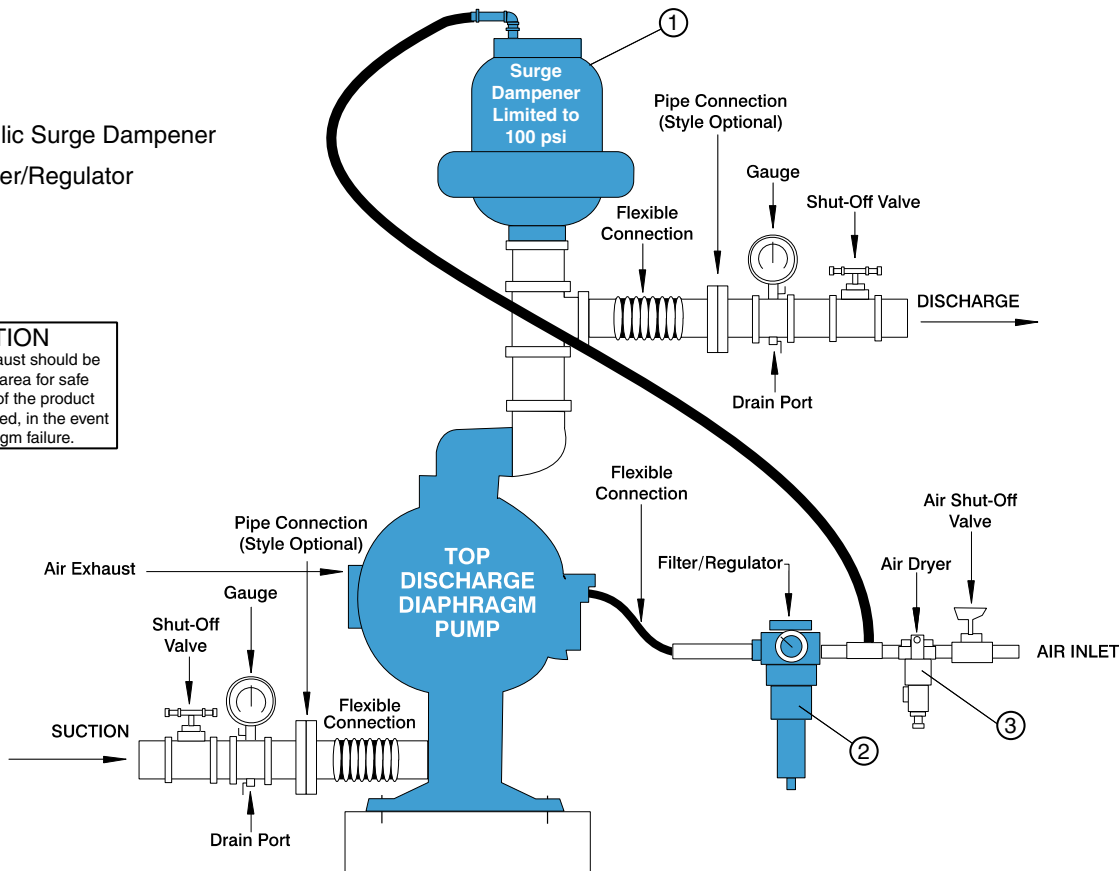
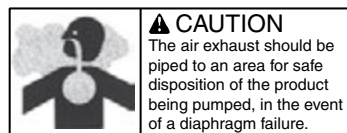

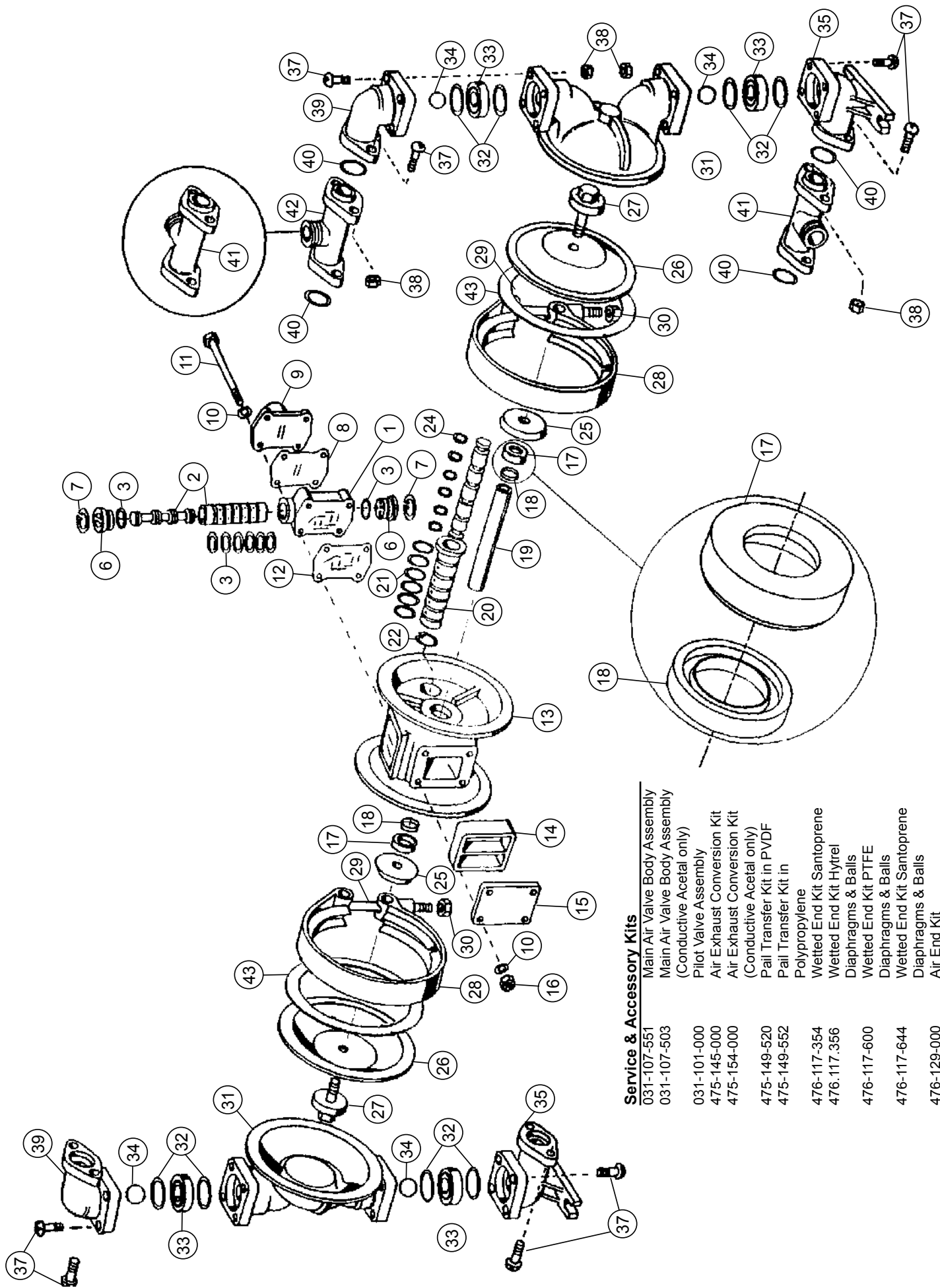

**Service & Accessory Kits**

031-107-551	Main Air Valve Body Assembly
031-107-503	Main Air Valve Body Assembly (Conductive Acetal only)
031-101-000	Pilot Valve Assembly
475-145-000	Air Exhaust Conversion Kit
475-154-000	Air Exhaust Conversion Kit (Conductive Acetal only)
475-149-520	Pail Transfer Kit in PVDF
475-149-552	Pail Transfer Kit in Polypropylene
476-117-354	Wetted End Kit Santoprene
476-117-356	Wetted End Kit Hytrel
476-117-600	Diaphragms & Balls Wetted End Kit PTFE
476-117-644	Diaphragms & Balls Wetted End Kit Santoprene
476-129-000	Diaphragms & Balls Air End Kit

# Composite Repair Parts List

ITEM	PART NO.	DESCRIPTION	QTY	ITEM	PART NO.	DESCRIPTION	QTY
1	095-077-551	Body, Main Air Valve	1	27	612-146-520	Plate, Outer Diaphragm	2
	⚠095-077-503	Body, Main Air Valve	1		⚠612-146-502	Plate, Outer Diaphragm	2
2	031-106-000	Sleeve & Spool Set	1		612-146-552	Plate, Outer Diaphragm	2
3	560-101-360	O-Rings	8	28	200-057-115	Clamp, V-Band	2
6	165-074-551	Cap, End with O-Ring	2	29	100-002-115	T-Bolt	2
	⚠165-074-503	Cap, End with O-Ring	2	30	545-027-337	Nut, Hex 1/4-28UNF	2
7	675-051-115	Ring, Retaining	2	31	196-145-520	Chamber, Outer	2
8	360-085-360	Gasket, Valve Body	1		⚠196-145-502	Chamber, Outer	2
	⚠360-085-379	Gasket, Valve Body (Conductive Acetal Only)	1		196-145-552	Chamber, Outer	2
9	165-072-551	Cap, Air Inlet	1	32	720-032-600	Seal, Check Valve	8
	⚠165-072-503	Cap, Air Inlet	1	33	722-073-520	Seat, Check Valve	4
10	901-037-115	Washer, Flat 1/4"	8		722-073-506	Seat, Check Valve	4
11	170-103-115	Capscrew, Hex Head 1/4-20 5" Long	4		722-073-552	Seat, Check Valve	4
12	360-084-360	Gasket, Intermediate Bracket	1	34	050-033-354	Ball, Check	4
	⚠360-084-379	Gasket, Intermediate Bracket (Conductive Acetal Only)	1		050-033-356	Ball, Check	4
13	114-019-551	Intermediate, Bracket	1	35	⚠312-095-520	Elbow, Suction	2
	⚠114-019-503	Intermediate, Bracket	1		312-095-502	Elbow, Suction	2
14	530-022-550	Muffler	1		312-095-552	Elbow, Suction	2
15	165-073-551	Cap, Air Exhaust	1	37	706-023-115	Screw, Machine 10-32UNF x 1" Long	32
	⚠165-073-503	Cap, Air Exhaust	1	38	544-004-115	Nut, Hex Flange 10-32UNF	16
16	545-003-115	Nut, Hex 1/4-20UNC	4	39	⚠312-096-520	Elbow, Discharge	2
17	449-021-551	Insert, Gland	2		312-096-502	Elbow, Discharge	2
	⚠449-021-503	Insert, Gland	2		312-096-552	Elbow, Discharge	2
18	720-031-359	Seal, K-R	2	40	720-033-600	Seal, Manifold	4
19	685-046-120	Rod, Diaphragm	1	41	⚠518-127-520	Manifold, Horizontal (Optional Discharge)	1/2
20	755-038-000	Sleeve, Pilot Valve with O-rings	1		518-127-502	Manifold, Horizontal (Optional Discharge)	1/2
21	560-066-360	O-rings	6		518-127-552	Manifold, Horizontal (Optional Discharge)	1/2
22	675-047-115	Ring, Retaining - Pilot Valve Sleeve	1	42	⚠518-128-520	Manifold, Vertical	1
23	775-038-000	Spool, Pilot Valve with O-rings	1		518-128-502	Manifold, Vertical	1
24	560-029-374	O-rings	6		518-128-552	Manifold, Vertical	1
25	612-147-150	Plate, Inner Diaphragm	2	43	⚠360-086-360	Gasket, Sealing	2
26	286-069-354	Diaphragm	2	54	920-025-000	Grounding Cable (Conductive Acetal Units Only)	1
	286-069-356	Diaphragm	2				
	286-070-600	Diaphragm	2				

Item not shown:

\*\*706-025-115 Screw, Machine 10-32UNF x .88" Long

\*\* (use in place of four 706-023-115 machine screws with horizontal manifold (item 41) on port side only when a pipe couple is installed on external 1/2" NPT porting threads.

## ⚠ Grounding The Pump (for Conductive Acetal Pumps only)



One eyelet end is fastened to the pump hardware.

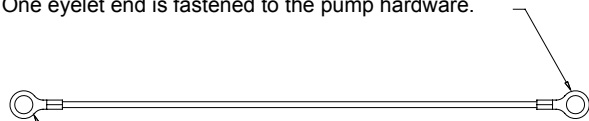

One eyelet is installed to a true earth ground.  
(Requires a 5/16 or 8mm maximum diameter bolt)

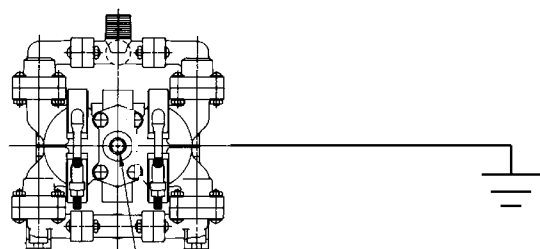

To be fully groundable, the pumps must be ATEX Compliant. Refer to pump data sheet for ordering.

This 8 foot long (244 centimeters) Grounding Cable (Item 54) is shipped with the eyelet fastened to the pump hardware.

To reduce the risk of static electrical sparking, this pump must be grounded. Check the local electrical code for detailed grounding instruction and the type of equipment required.

	<b>⚠ WARNING</b>
	<p><i>Take action to prevent static sparking. Fire or explosion can result, especially when handling flammable liquids. The pump, piping, valves, containers or other miscellaneous equipment must be grounded.</i></p>

# Solenoid Shifted Option Drawing

## SOLENOID SHIFTED AIR VALVE PARTS LIST

(Includes all items used on Composite Repair Parts List except as shown)

ITEM	PART NUMBER	DESCRIPTION	QTY
22	675-047-115	Ring, Retaining - Pilot Plug Sleeve	2
44	755-037-000	Pilot Plug Sleeve with O-rings	1
45	360-106-360	Gasket, Intermediate Bracket	1
46	241-001-000	Connector, conduit	1
47	893-095-000	Solenoid Valve, NEMA 4	1
48	219-001-000	Solenoid Coil, 24 VDC	1
	219-004-000	Solenoid Coil, 24 VAC/12 VDC	1
	219-002-000	Solenoid Coil, 120 VAC	1
	219-003-000	Solenoid Coil, 240 VAC	1
49	866-068-000	Tube Fitting	1
50	538-083-555	Nipple	1
51	835-009-555	Tee, Pipe	1
52	860-062-540	Tubing	1
53	866-069-000	Tube Fitting	1

## FOR EXPLOSION PROOF SOLENOID VALVE

48	219-009-001	Solenoid Coil, 120VAC 60 Hz	1
	219-009-002	Solenoid Coil, 240VAC 60 Hz	1
	219-009-003	Solenoid Coil, 12VDC	1
	219-009-004	Solenoid Coil, 24VDC	1
	219-009-005	Solenoid Coil, 110VAC 50 Hz	1
	219-009-006	Solenoid Coil, 230VAC 50 Hz	1

**ASSEMBLY INSTRUCTIONS: Must Be Performed Prior To Start-Up.** The tee (item 51), nipple (item 50), fitting (item 53) and tubing (item 52) have been pre-assembled at the factory. Thread this assembly into the air inlet cap (item 9). Be careful not to over tighten. Push the free end of the tubing into the fitting (item 49) which is attached to the valve.

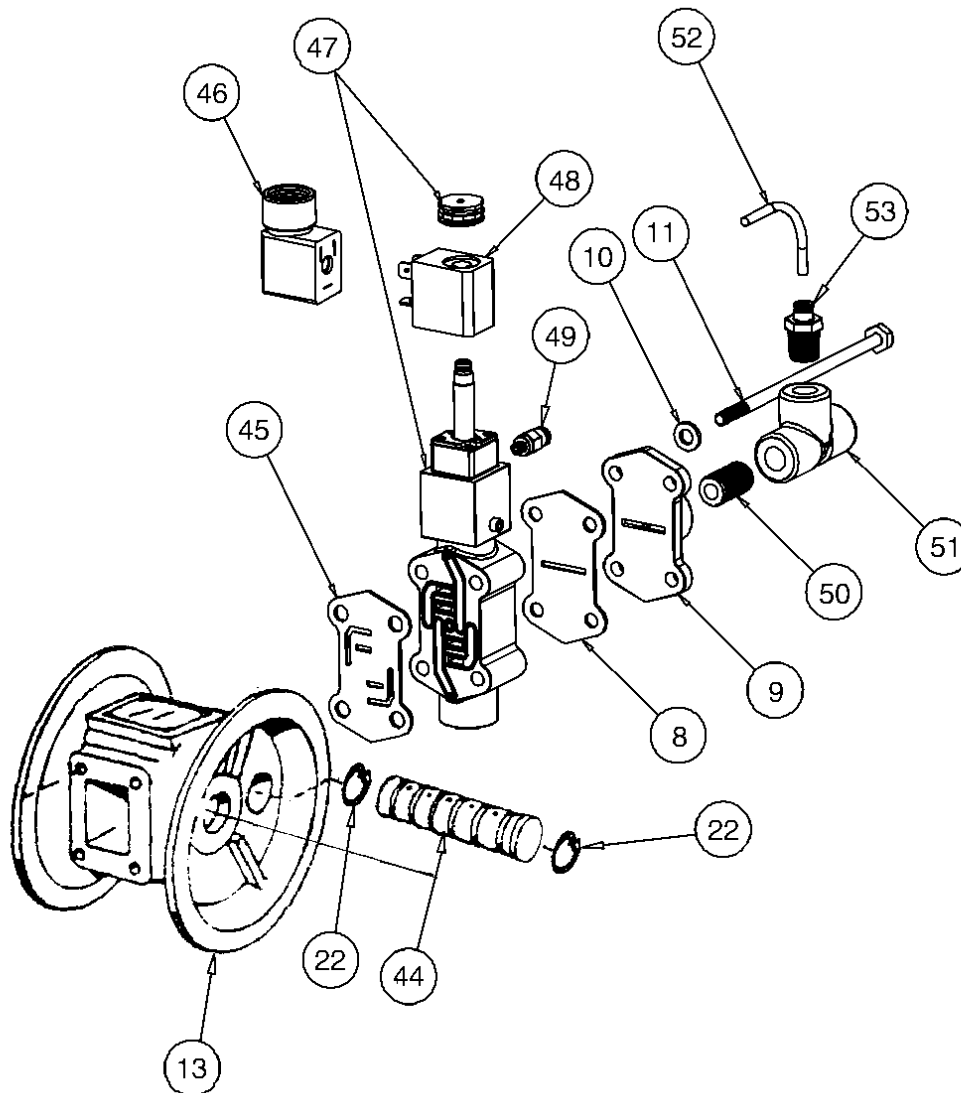

## SOLENOID SHIFTED AIR DISTRIBUTION VALVE OPTION

Warren Rupp's solenoid shifted, air distribution valve option utilizes electrical signals to precisely control your SANDPIPER's speed. The solenoid coil is connected to a customer - supplied control. Compressed air provides the pumping power, while electrical signals control pump speed (pumping rate).

### OPERATION

The Solenoid Shifted SANDPIPER has a solenoid operated, air distribution valve in place of the standard SANDPIPER's pilot operated, air distribution valve. Where a pilot valve is normally utilized to cycle the pump's air distribution valve, an electric solenoid is utilized. As the solenoid is powered, one of the pump's air chambers is pressurized while the other chamber is exhausted. When electric power is turned off, the solenoid shifts and the pressurized chamber is exhausted while the other chamber is pressurized. By alternately applying and removing power to the solenoid, the pump cycles much like a standard SANDPIPER pump, with one exception. This option provides a way to precisely control and monitor pump speed.

### BEFORE INSTALLATION

Before wiring the solenoid, make certain it is compatible with your system voltage.

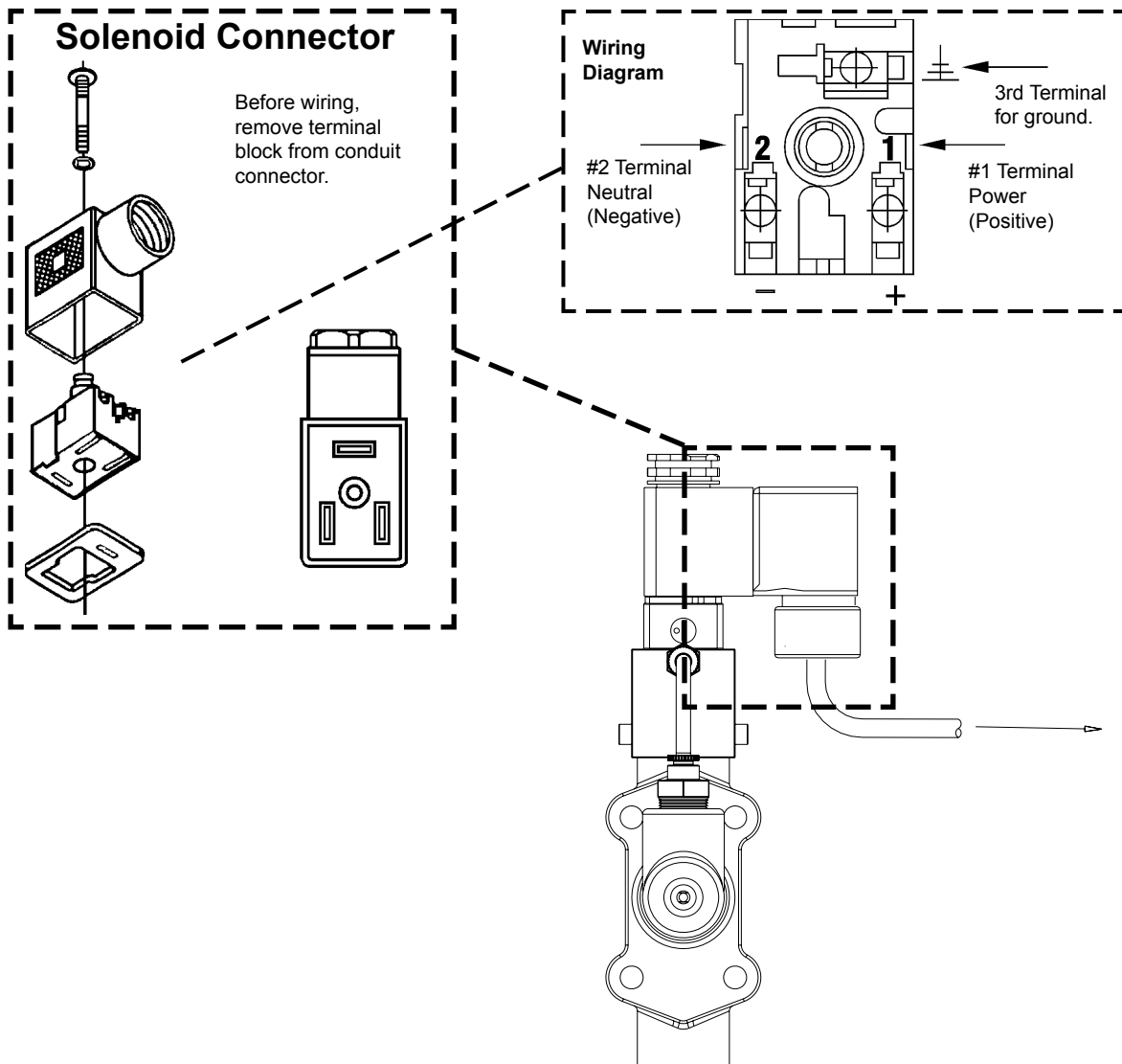

# 5 - YEAR Limited Product Warranty

Warren Rupp, Inc. ("Warren Rupp") warrants to the original end-use purchaser that no product sold by Warren Rupp that bears a Warren Rupp brand shall fail under normal use and service due to a defect in material or workmanship within five years from the date of shipment from Warren Rupp's factory. Warren Rupp brands include Warren Rupp®, SANDPIPER®, SANDPIPER Signature Series™, MARATHON®, Porta-Pump®, SludgeMaster™ and Tranquilizer®.

The use of non-OEM replacement parts will void (or negate) agency certifications, including CE, ATEX, CSA, 3A and EC1935 compliance (Food Contact Materials). Warren Rupp, Inc. cannot ensure nor warrant non-OEM parts to meet the stringent requirements of the certifying agencies.

~ See [sandpiperpump.com/content/warranty-certifications](http://sandpiperpump.com/content/warranty-certifications) for complete warranty, including terms and conditions, limitations and exclusions. ~

**WARREN  
RUPP, INC.**

## Declaration of Conformity

**Manufacturer: Warren Rupp, Inc., 800 N. Main Street  
Mansfield, Ohio, 44902 USA**

Certifies that Air-Operated Double Diaphragm Pump Series: HDB, HDF, M Non-Metallic, S Non-Metallic, M Metallic, S Metallic, T Series, G Series, U Series, EH and SH High Pressure, RS Series, W Series, SMA and SPA Submersibles, and Tranquilizer® Surge Suppressors comply with the European Community Directive 2006/42/EC on Machinery, according to Annex VIII. This product has used Harmonized Standard EN809:1998+A1:2009, Pumps and Pump Units for Liquids - Common Safety Requirements, to verify conformance.

David Roseberry  
Signature of authorized person

David Roseberry  
Authorised Representative:  
IDEX Pump Technologies  
R79 Shannon Industrial Estate,  
Shannon, Co. Clare  
Ireland

October 20, 2005  
Date of issue

Engineering Manager  
Title

February 27, 2017  
Date of revision



Revision Level: F



# **WARREN RUPP, INC.**

## **EC / EU Declaration of Conformity**

The objective of the declaration described is in conformity with the relevant Union harmonisation legislation: Directive 94/9/EC (until April 19, 2016) and Directive 2014/34/EU (from April 20, 2016).

**Manufacturer:**

Warren Rupp, Inc.  
A Unit of IDEX Corporation  
800 North Main Street  
P.O. Box 1568  
Mansfield, OH 44902 USA

**Applicable Standard:**

EN13463-1: 2001  
EN13463-5: 2003  
EN60079-25: 2004

**Harmonised Standard:**

EN13463-1: 2009  
EN13463-5: 2011  
EN60079-25:2010

The harmonised standards have been compared to the applicable standards used for certification purposes and no changes in the state of the art technical knowledge apply to the listed equipment.

**AODD Pumps and Surge Suppressors**

Technical File No.: 203104000-1410/MER

**AODD (Air-Operated Double Diaphragm) Pumps**

EC Type Examination Certificate No. Pumps: KEMA 09ATEX0071 X

DEKRA Certification B.V. (0344)  
Meander 1051  
6825 MJ Arnhem  
The Netherlands

**Hazardous Locations Applied:**

I M1 c	II 1 G c T5
II 2 G Ex ia c IIC T5	II 1 D c T100°C
II 2 D Ex c iaD 20 IP67 T100°C	II 2 G c T5
II 2 G Eex m c II T5	II 2 D c T100°C
II 2 D c IP65 T100°C	II 2 G c IIB T5

**SANDPIPER®**  
A WARREN RUPP, INC. BRAND

**Tranquilizer®**

DATE/APPROVAL/TITLE:  
18 March 2016

*David Roseberry*  
David Roseberry, Director of Engineering

**IDEX**