

CONTATTI ELETTRICI

Dispositivi da applicare a manometri o termometri per ottenere un intervento elettrico in corrispondenza di determinati valori di pressione o temperatura, su apparecchiature come motori, pompe, sirene d'allarme. I valori sono impostabili su tutta la scala dello strumento attraverso indici manovrabili dall'esterno.

E' possibile, in caso di vibrazioni dell'impianto o pressioni pulsanti, prevedere il riempimento dello strumento con olio dielettrico.

Sono disponibili inoltre contatti induttivi a sicurezza intrinseca per impieghi in zone a rischio di esplosione e contatti specifici per essere utilizzati come ingresso a PLC.

Devices to be put on pressure or temperature gauges in order to obtain an electrical intervention in correspondence with some pressure or temperature values, on machines such as engines, pumps, alarms. The values can be placed all over the scale of the gauge by externally adjustable pointers.

In case of vibrations of the installation or pulsating pressures, it is possible to fill the gauge with dielectric oil.

Intrinsically safe inductive contacts are also available to be used in explosion risk zones and specific contacts to be used as PLC inputs.

ELECTRIC CONTACTS



CARATTERISTICHE COSTRUTTIVE

DIMENSIONI NOMINALI STRUMENTI (mm):

100 – 150 – 96 x 96 – 144 x 144

ERRORE AGGIUNTO: 0,5% del valore di fondo scala.

GRADO DI PROTEZIONE: IP55 (IP65 con riempimento di liquido).

MATERIALE CALOTTA: policarbonato trasparente.

SET POINT: regolabile su tutta la scala dall'esterno

- con bottone fisso sulla calotta;
- con chiave estraibile.

COLLEGAMENTO ELETTRICO:

- pressacavo PG7 con cavo lg. 1 metro (conduttori di sez. 0,5 mm²) per strumenti con attacco radiale e posteriore.
- connettore ad innesto per strumenti con attacco radiale
 - 4 poli e pressacavo PG 9 grado di protezione IP55
 - 6 poli e pressacavo PG13,5 grado di protezione IP65

DESIGN FEATURES

NOMINAL SIZE OF GAUGES (mm):

100 – 150 – 96 x 96 – 144 x 144

ADDED ERROR: 0,5% of full scale value.

DEGREE OF PROTECTION: IP55 (IP65 with liquid filling).

CAP MATERIAL: transparent polycarbonate.

SET POINT: externally adjustable all over the scale .

- with fixed button on the cap;
- with drawing out key.

ELECTRIC CONNECTION:

- cable gland PG7 with 1 meter cable length (conductors 0,5 mm²) for gauges with bottom and back connection.
- Plug connector for gauges with bottom connection
 - 4 poles and cable gland PG 9 degree of protection IP55
 - 6 poles and cable gland PG13,5 degree of protection IP65

DIMENSIONI (mm)

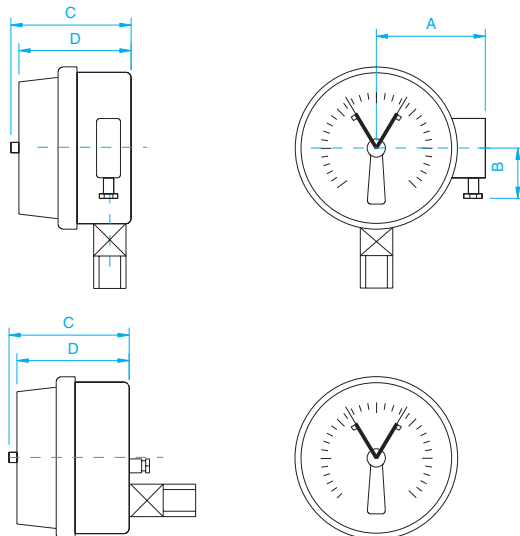

DIMENSIONS (mm)

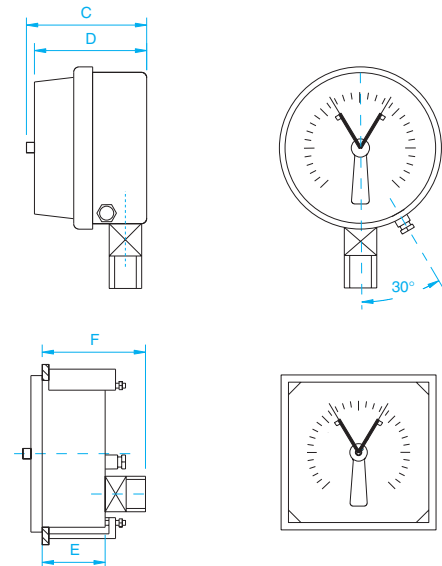

DN / DS	A	B	C	D	E	F
100	94	47	94	82	—	—
150	119	47	94	82	—	—
96 x 96	—	—	—	—	77	111
144 x 144	—	—	—	—	75	109

CONTATTI ELETTRICI
ELECTRIC CONTACTS

Usati in condizioni normali di esercizio senza vibrazioni e con bassa capacità di intervento. Possibilità di aggiungere un bloccetto magnetico per aumentare la sicurezza del contatto, la durata e insensibilità alle vibrazioni.

Used in normal exercise conditions without vibrations and low switching capacity. It is possible to add a magnetic device to assure contact safety, long life and wide insensibility to vibrations.

MATERIALE CONTATTO: Lega Ag/Ni dorato 5 µm
AVVICINAMENTO MAX DEI CONTATTI: 2%
POTENZA DI ROTTURA: 10W/18VA (30W/18VA contatti magnetici)
TEMPERATURA AMBIENTE: - 20 ÷ 60 °C

CONTACT MATERIAL: Ag/Ni alloy gold plated 5 µm
MAX APPROACH OF CONTACT: 2%
BREAK RATING: 10W/18VA (30W/18VA magnetic contacts)
AMBIENT TEMPERATURE: - 20 ÷ 60 °C

TABELLA DI CARICO LOAD TABLE			
[V]	AC [mA]	DC [mA]	Carico Induttivo / Inductive load [mA]
230	45	40	25
110	90	80	45
50	170	120	70
24	350	200	100

TABELLA DI CARICO CONTATTI MAGNETICI LOAD TABLE WITH MAGNETIC CONTACTS			
[V]	AC [mA]	DC [mA]	Carico Induttivo / Inductive load [mA]
230	120	100	65
110	240	200	130
50	450	300	200
24	600	400	250

SCHEMI DI FUNZIONAMENTO / FUNCTIONING SCHEME

Funzionale Functional	Elettrico Electrical	Codice Code	Descrizione	Description
		1 NC	Contatto singolo Normalmente Chiuso La lancetta superando il valore impostato in senso orario apre il contatto	Single contact Normally Closed: The pointer overcoming clockwise the set point opens the contact
		1 NA	Contatto singolo Normalmente Aperto: La lancetta superando il valore impostato in senso orario chiude il contatto	Single contact Normally Open: The pointer overcoming clockwise the set point closes the contact
		2 NA NA	Contatto doppio Normalmente Aperto / Normalmente Aperto La lancetta superando in senso orario i valori impostati di min. e max.: chiude il 1° contatto chiude il 2° contatto	Double contact Normally Open / Normally Open: The pointer overcoming clockwise the min. and max. set points closes 1st contact closes 2nd contact
		2 NA NC	Contatto doppio Normalmente Aperto / Normalmente Chiuso La lancetta superando in senso orario i valori impostati di min. e max.: chiude il 1° contatto apre il 2° contatto	Double contact Normally Open / Normally Closed: The pointer overcoming clockwise the min. and max. set points closes 1st contact opens 2nd contact
		2 NC NA	Contatto doppio Normalmente Chiuso / Normalmente Aperto La lancetta superando in senso orario i valori impostati di min. e max.: apre il 1° contatto chiude il 2° contatto	Double contact Normally Closed / Normally Open: The pointer overcoming clockwise the min. and max. set points opens 1st contact closes 2nd contact
		2 NC NC	Contatto doppio Normalmente Chiuso / Normalmente Chiuso La lancetta superando in senso orario i valori impostati di min. e max.: apre il 1° contatto apre il 2° contatto	Double contact Normally Closed / Normally Closed: The pointer overcoming clockwise the min. and max. set points opens 1st contact opens 2nd contact
		2 I NA NA	Contatto doppio a circuiti indipendenti Normalmente Aperto / Normalmente Aperto La lancetta superando in senso orario i valori impostati di min. e max.: chiude il 1° contatto chiude il 2° contatto	Double contact separate circuits Normally Open / Normally Open: The pointer overcoming clockwise the min. and max. set points closes 1st contact closes 2nd contact
		2 I NA NC	Contatto doppio a circuiti indipendenti Normalmente Aperto / Normalmente Chiuso La lancetta superando in senso orario i valori impostati di min. e max.: chiude il 1° contatto apre il 2° contatto	Double contact separate circuits Normally Open / Normally Closed: The pointer overcoming clockwise the min. and max. set points closes 1st contact opens 2nd contact
		2 I NC NA	Contatto doppio a circuiti indipendenti Normalmente Chiuso / Normalmente Aperto La lancetta superando in senso orario i valori impostati di min. e max.: apre il 1° contatto chiude il 2° contatto	Double contact separate circuits Normally Closed / Normally Open: The pointer overcoming clockwise the min. and max. set points opens 1st contact closes 2nd contact
		2 I NC NC	Contatto doppio a circuiti indipendenti Normalmente Chiuso / Normalmente Chiuso La lancetta superando in senso orario i valori impostati di min. e max.: apre il 1° contatto apre il 2° contatto	Double contact separate circuits Normally Closed / Normally Closed: The pointer overcoming clockwise the min. and max. set points opens 1st contact opens 2nd contact

Campo scala con contatto chiuso / Range with closed contact

Campo scala con contatto aperto / Range with open contact

CONTATTI INDUTTIVI
INDUCTIVE CONTACTS













I contatti induttivi sono adatti per essere utilizzati in zone a rischio di esplosione e sono corredati di certificazione a sicurezza intrinseca con grado di protezione Eex ib IIC T6. Dato il tipo di funzionamento senza contatto, sono inoltre impiegati dove si richiedano affidabilità e alte frequenze di intervento.

The inductive contacts are suitable for explosion risk zones and are supplied with intrinsically safe certification with protection degree Eex ib IIC T6. Since they work without contact, they are particularly used when safeness and many interventions are requested.

TENSIONE DI ALIMENTAZIONE: 8 VDC
TEMPERATURA AMBIENTE: - 20 ÷ 60 °C

SUPPLY VOLTAGE: 8 VDC
AMBIENT TEMPERATURE: - 20 ÷ 60 °C

SCHEMI DI FUNZIONAMENTO / FUNCTIONING SCHEME

Funzionale <i>Functional</i>	Elettrico <i>Electrical</i>	Codice <i>Code</i>	Descrizione	Description
		I 1	Contatto induttivo singolo - La lancetta superando in senso orario il valore impostato: chiude il contatto	Single inductive contact The pointer overcoming the set point clockwise closes the contact
		I 2	Contatto induttivo singolo - La lancetta superando in senso orario il valore impostato: apre il contatto	Single inductive contact The pointer overcoming the set point clockwise opens the contact
		I 11	Contatto induttivo doppio - La lancetta superando in senso orario i valori impostati: chiude il 1° contatto chiude il 2° contatto	Double inductive contact The pointer overcoming the set points clockwise closes 1st contact closes 2nd contact
		I 12	Contatto induttivo doppio - La lancetta superando in senso orario i valori impostati: chiude il 1° contatto apre il 2° contatto	Double inductive contact The pointer overcoming the set points clockwise closes 1st contact opens 2nd contact
		I 21	Contatto induttivo doppio - La lancetta superando in senso orario i valori impostati: apre il 1° contatto chiude il 2° contatto	Double inductive contact The pointer overcoming the set points clockwise opens 1st contact closes 2nd contact
		I 22	Contatto induttivo doppio - La lancetta superando in senso orario i valori impostati: apre il 1° contatto apre il 2° contatto	Double inductive contact The pointer overcoming the set points clockwise opens 1st contact opens 2nd contact

CONTATTI ELETTRONICI
ELECTRONIC CONTACTS

I contatti elettronici grazie al loro tipo di commutazione senza contatto, sono adatti per piccoli carichi di corrente continua (< 100 mA) e quindi in particolare:













The electronic contacts are suitable for small loads of direct current, thanks to their type of switching without contact, and in particular:

- come segnali di ingresso per PLC collegandoli direttamente;
- per accoppiatori optoelettronici;
- per tutti i dispositivi elettronici.

- as PLC inputs;
- for optoelectronic devices;
- for every electronic devices.

TENSIONE DI ALIMENTAZIONE: 10 ÷ 30 VDC
CAPACITÀ DI INTERVENTO: ≤ 100 mA
TEMPERATURA AMBIENTE: - 20 ÷ 60 °C

SUPPLY VOLTAGE: 10 ÷ 30 VDC
BREAKING CAPACITY: ≤ 100 mA
AMBIENT TEMPERATURE: - 20 ÷ 60 °C

Funzionale <i>Functional</i>	Elettrico <i>Electrical</i>	Codice <i>Code</i>	Descrizione	Description
		E 1	Contatto elettronico singolo - La lancetta superando in senso orario il valore impostato: chiude il contatto	Single electronic contact The pointer overcoming the set point clockwise closes the contact
		E 2	Contatto elettronico singolo - La lancetta superando in senso orario il valore impostato: apre il contatto	Single electronic contact The pointer overcoming the set point clockwise opens the contact
		E 11	Contatto elettronico doppio - La lancetta superando in senso orario i valori impostati: chiude il 1° contatto chiude il 2° contatto	Double electronic contact The pointer overcoming the set points clockwise closes 1st contact closes 2nd contact
		E 12	Contatto elettronico doppio - La lancetta superando in senso orario i valori impostati: chiude il 1° contatto apre il 2° contatto	Double electronic contact The pointer overcoming the set points clockwise closes 1st contact opens 2nd contact
		E 21	Contatto elettronico doppio - La lancetta superando in senso orario i valori impostati: apre il 1° contatto chiude il 2° contatto	Double electronic contact The pointer overcoming the set points clockwise opens 1st contact closes 2nd contact
		E 22	Contatto elettronico doppio - La lancetta superando in senso orario i valori impostati: apre il 1° contatto apre il 2° contatto	Double electronic contact The pointer overcoming the set points clockwise opens 1st contact opens 2nd contact

ACCESSORI**ACCESSORIES****UNITÀ DI COMANDO PER CONTATTI INDUTTIVI****SWITCH UNIT FOR INDUCTIVE CONTACT**

Si impiegano come interfaccia tra una apparecchiatura posta in zona sicura ed un contatto induttivo che opera in zona a rischio di esplosione. Comprendono un alimentatore per il contatto induttivo, un analizzatore e un relè di uscita.

They are used as interface between a machine which is in a safe zone and an inductive contact which works in an explosion risk zone. They include a main power supply for the inductive contact, an analyzer and an output relay.

ALIMENTAZIONE: 24 – 230 Vac

SUPPLY: 24 – 230 Vac

INGRESSO (intrinsecamente sicuro NAMUR o DIN 19234) : 8 V

INPUT (intrinsically safe to NAMUR and DIN 19234) : 8 V

USCITA (non intrinsecamente sicura): relè con contatto in scambio.

OUTPUT (not intrinsically safe): relay with changeover contact

TEMPERATURA AMBIENTE: - 25 ÷ 60 °C

AMBIENT TEMPERATURE: - 25 ÷ 60 °C

COME ORDINARE**HOW TO ORDER**

- Individuare il modello e le caratteristiche dello strumento;
- Verificare che tra gli accessori sia indicato il contatto elettrico;
- Individuare il tipo e la funzione del contatto in base alle tabelle precedenti;
- Individuare il tipo di collegamento elettrico (connettore / pressacavo);
- Specificare se lo strumento deve essere riempito di liquido.

- Choose the model and characteristic of the gauge;
- Check among the accessories whether it is indicated the electric contact or not;
- Find out the type and function of contact according to the previous tables;
- Find out the type of electrical connector (plug connector /cable gland);
- Specify the filling of liquid.

ESEMPIO:

MX1 DN100 0/6 bar 1/2GAS + 2 NA NC + pressacavo con cavo Lg 1 m

EXAMPLE

MX1 DS100 0/6 bar G1/2 + 2NANC + cable gland and cable 1 m long.



OMET di Ceresa srl

OFFICINA MANOMETRI E TERMOMETRI

Via Sette Martiri, 26 – 20060 PESSANO CON BORNAGO (MI)

Tel. +39 02 9504100 – 95741057 - Fax. +39 02 95742772 - web: www.ometitalia.it